



History-Based Value Report

History events affecting this vehicle's value



Service History



Personal Vehicle



Minor Damage

\$5,250 Retail Value



Vehicle History Report™

US \$44.99

**2007 MAZDA MAZDA3
S GRAND TOURING**

VIN: JM1BK323071735903
SEDAN 4 DR
2.3L I4 F DOHC 16V
GASOLINE
FRONT WHEEL DRIVE

Accident reported: minor damage

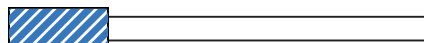

MINOR MODERATE SEVERE



40 Service history records



2 Previous owners





Personal vehicle



138,158 Last reported odometer reading

This CARFAX Vehicle History Report is based only on information supplied to CARFAX and available as of 1/13/24 at 7:24:29 AM (CST). Other information about this vehicle, including problems, may not have been reported to CARFAX. Use this report as one important tool, along with a vehicle inspection and test drive, to make a better decision about your next used car.

|  Ownership History The number of owners is estimated | Owner 1 | Owner 2 |
|---|----------|-------------|
| Year purchased | 2007 | 2007 |
| Type of owner | Personal | Personal |
| Estimated length of ownership | 3 months | 2 years |
| Owned in the following states/provinces | Virginia | See Details |
| Estimated miles driven per year | -- | 12,707/yr |
| Last reported odometer reading | 5,164 | 138,158 |

|  Title History CARFAX guarantees the information in this section | Owner 1 | Owner 2 |
|---|---|---|
| Damage Brands Salvage Junk Rebuilt Fire Flood Hail Lemon | <input checked="" type="checkbox"/> Guaranteed No Problem | <input checked="" type="checkbox"/> Guaranteed No Problem |
| Odometer Brands Not Actual Mileage Exceeds Mechanical Limits | <input checked="" type="checkbox"/> Guaranteed No Problem | <input checked="" type="checkbox"/> Guaranteed No Problem |
|  GUARANTEED - None of these title problems were reported by a U.S. state Department of Motor Vehicles (DMV). If you find that any of these title problems were reported by a DMV and not included in this report, you may qualify. View Terms View Certificate | | |

|  Additional History Not all accidents / issues are reported to CARFAX | Owner 1 | Owner 2 |
|--|---|---|
| Total Loss No total loss reported to CARFAX. | <input checked="" type="checkbox"/> No Issues Reported | <input checked="" type="checkbox"/> No Issues Reported |
| Structural Damage CARFAX recommends that you have this vehicle inspected by a collision repair specialist. | <input checked="" type="checkbox"/> No Issues Reported | <input checked="" type="checkbox"/> No Issues Reported |
| Airbag Deployment No airbag deployment reported to CARFAX. | <input checked="" type="checkbox"/> No Issues Reported | <input checked="" type="checkbox"/> No Issues Reported |
| Odometer Check No indication of an odometer rollback. | <input checked="" type="checkbox"/> No Issues Indicated | <input checked="" type="checkbox"/> No Issues Indicated |
| Accident / Damage Accident reported: 11/10/2017. Damage reported: 06/25/2019. | <input checked="" type="checkbox"/> No Issues Reported | Minor Damage |

| | | |
|---|---|---|
| Manufacturer Recall | <input checked="" type="checkbox"/> No Recalls Reported | <input checked="" type="checkbox"/> No Recalls Reported |
| Basic Warranty | Warranty Expired | Warranty Expired |
| Check with an authorized Mazda dealer for any open recalls. | | |
| Original warranty estimated to have expired. | | |





Detailed History



Owner 1
Purchased: 2007

Personal Vehicle

| Date | Mileage | Source | Comments |
|------------|---------|--|---|
| 05/11/2007 | | NICB | Vehicle manufactured and shipped to original dealer |
| 05/14/2007 | 15 | Preston Mazda Hurlock, MD 877-898-2470 prestonmotor.com/about-us/ ★ 4.7 / 5.0 39 Verified Reviews ❤️ 37 Customer Favorites | Vehicle serviced Pre-delivery inspection completed |
| 05/21/2007 | 179 | Priority Auto Group 757-523-1700 priorityauto.com | Vehicle serviced Pre-delivery inspection completed Vehicle washed/detailed Front license plate bracket installed/replaced Emissions or safety inspection performed |
| 05/22/2007 | 185 | Virginia Motor Vehicle Dept. | Vehicle purchase reported Titled or registered as personal vehicle |
| 06/13/2007 | | Virginia Motor Vehicle Dept. Virginia Beach, VA | Title or registration issued First owner reported |
| 08/30/2007 | | Farrish of Fairfax Fairfax, VA 703-934-1600 farrishcars.com ★ 4.3 / 5.0 660 Verified Reviews ❤️ 1,338 Customer Favorites | Vehicle serviced Pre-delivery inspection completed |

| | | | |
|------------|-------|---|------------------------------------|
| 08/31/2007 | 5,120 | Virginia Inspection Station Fairfax, VA | Passed emissions inspection |
| 09/03/2007 | 5,124 | Dealer Inventory Fairfax, VA | Vehicle offered for sale |
| 10/15/2007 | 5,164 | Farrish of Fairfax Fairfax, VA 703-934-1600 farrishcars.com  4.3 / 5.0 660 Verified Reviews  1,338 Customer Favorites | Vehicle sold |









Owner 2
Purchased: 2007











Low mileage! This owner drove less than the industry average of 15,000 miles per year.





Personal Vehicle
12,707 mi/yr





| Date | Mileage | Source | Comments |
|------------|---------|---|---|
| 10/15/2007 | | Virginia Motor Vehicle Dept. | Vehicle purchase reported |
| 11/05/2007 | | Virginia Motor Vehicle Dept. Leesburg, VA | Title or registration issued New owner reported |
| 09/06/2008 | 20,169 | Service Facility Vienna, VA |  Vehicle serviced Maintenance inspection completed 22,500 mile service performed Oil and filter changed Four wheel alignment performed Tune-up performed Battery/charging system checked Brakes checked Tire condition and pressure checked |
| 10/07/2008 | | Virginia Motor Vehicle Dept. Leesburg, VA | Registration issued or renewed Loan or lien reported |
| 12/26/2008 | 23,647 | Service Facility Vienna, VA |  Vehicle serviced Maintenance inspection completed Tire condition and pressure checked Battery/charging system checked Brakes checked Oil and filter changed |





| | | | | |
|------------|--------|---|---|---|
| 08/28/2009 | 32,075 | Service Facility Vienna, VA |  | Vehicle serviced Maintenance inspection completed 30,000 mile service performed Cabin air filter replaced/cleaned Radio installed |
| 09/18/2009 | 32,605 | Service Facility Vienna, VA |  | Vehicle serviced CD player/changer reinstalled |
| 11/06/2009 | | Florida Motor Vehicle Dept. | | Vehicle purchase reported |
| 11/06/2009 | 35,000 | New Jersey Motor Vehicle Dept. Montclair, NJ Title #EO20093100394 | | Title issued or updated Registration issued or renewed Loan or lien reported Registration updated when owner moved the vehicle to a new location Vehicle color noted as Silver |
| 11/10/2009 | 35,230 | Pep Boys Bridgewater, NJ 732-560-9559 pepboys.com ★ 4.3 / 5.0 221 Verified Reviews ❤️ 18 Customer Favorites |  | Vehicle serviced Oil and filter changed |
| 03/28/2011 | 59,010 | Grieco Mazda Delray Beach, FL 561-278-7800 griecomazda.com ★ 4.5 / 5.0 432 Verified Reviews ❤️ 5,623 Customer Favorites |  | Vehicle serviced Recommended maintenance performed Maintenance inspection completed 60,000 mile service performed Tire condition and pressure checked Engine mount(s) replaced Front wheel bearing(s)/hub(s) replaced Oil pan gasket replaced Four wheel alignment performed Alignment performed Engine checked Battery/charging system checked Brakes checked |
| 05/14/2011 | 60,760 | Grieco Mazda Delray Beach, FL 561-278-7800 griecomazda.com ★ 4.5 / 5.0 432 Verified Reviews ❤️ 5,623 Customer Favorites |  | Vehicle serviced Tire condition and pressure checked Brakes checked Battery/charging system checked |

| | | | |
|-------------------|--|---|--|
| 07/12/2011 62,587 | <p>Grieco Mazda Delray Beach, FL 561-278-7800 griecomazda.com</p> <p>★ 4.5 / 5.0 432 Verified Reviews Customer Favorites ♥ 5,623</p> |  | <p>Vehicle serviced Oil and filter changed Tire(s) balanced Tire condition and pressure checked Tires rotated Engine checked Brakes checked Battery/charging system checked</p> |
| 10/25/2011 | <p>New Jersey Motor Vehicle Dept. Montclair, NJ Title #V320112980092</p> | <p>Title issued or updated Duplicate title issued Vehicle color noted as Silver</p> | |
| 11/23/2011 | <p>Grieco Mazda Delray Beach, FL 561-278-7800 griecomazda.com</p> <p>★ 4.5 / 5.0 432 Verified Reviews Customer Favorites ♥ 5,623</p> |  | <p>Vehicle serviced Battery serviced Fluids checked Oil and filter changed Tires rotated Battery/charging system checked Brakes checked Tire condition and pressure checked</p> |
| 11/23/2011 66,791 | <p>Florida Motor Vehicle Dept. Boca Raton, FL Title #0107629575</p> | <p>Title issued or updated Title or registration issued Titled or registered as personal vehicle Registration updated when owner moved the vehicle to a new location Vehicle color noted as Silver</p> | |
| 01/21/2012 70,049 | <p>Grieco Mazda Delray Beach, FL 561-278-7800 griecomazda.com</p> <p>★ 4.5 / 5.0 432 Verified Reviews Customer Favorites ♥ 5,623</p> |  | <p>Vehicle serviced Recommended maintenance performed Fluids checked Oil and filter changed Battery/charging system checked Brakes checked Tire condition and pressure checked</p> |
| 06/05/2012 74,190 | <p>Grieco Mazda Delray Beach, FL 561-278-7800 griecomazda.com</p> <p>★ 4.5 / 5.0 432 Verified Reviews Customer Favorites ♥ 5,623</p> |  | <p>Vehicle serviced Battery/charging system checked Brakes checked Tire condition and pressure checked</p> |

| | | | |
|-------------------|---|---|---|
| 07/09/2012 75,223 | <p>Grieco Mazda Delray Beach, FL 561-278-7800 griecomazda.com</p> |  | <p>Vehicle serviced Maintenance inspection completed Recommended maintenance performed Battery/charging system checked Brakes checked Four wheel alignment performed Tire condition and pressure checked Alignment performed Five tires mounted Four tires mounted Drive belts adjusted Oil and filter changed Tires rotated Wheel(s) repaired</p> |
| 10/31/2012 78,425 | <p>Grieco Mazda Delray Beach, FL 561-278-7800 griecomazda.com</p> |  | <p>Vehicle serviced Battery/charging system checked Brakes checked Fluids checked Oil and filter changed Tire condition and pressure checked</p> |
| 02/22/2013 81,377 | <p>Grieco Mazda Delray Beach, FL 561-278-7800 griecomazda.com</p> |  | <p>Vehicle serviced Battery/charging system checked Brakes checked Battery serviced Fluids checked Oil and filter changed Tires rotated Tire condition and pressure checked</p> |
| 09/06/2013 86,029 | <p>Grieco Mazda Delray Beach, FL 561-278-7800 griecomazda.com</p> |  | <p>Vehicle serviced Recommended maintenance performed 30,000 mile service performed 80,000 mile service performed Brakes checked Tire(s) balanced Tire condition and pressure checked Oil and filter changed Four wheel alignment performed</p> |
| 09/14/2013 | <p>Florida Motor Vehicle Dept. Boca Raton, FL Title #0107629575</p> | | <p>Registration issued or renewed Titled or registered as personal vehicle Registration updated when owner moved the vehicle to a new location Vehicle color noted as Silver</p> |

| | | |
|-------------------|--|--|
| 12/24/2013 89,389 | <p>Grieco Mazda Delray Beach, FL 561-278-7800 griecomazda.com</p> <p>★ 4.5 / 5.0 432 Verified Reviews Customer Favorites ♥ 5,623</p> | <p> Vehicle serviced Maintenance inspection completed Battery/charging system checked Brakes checked Engine timing/front cover gasket replaced Tire condition and pressure checked</p> |
| 03/03/2014 92,177 | <p>Grieco Mazda Delray Beach, FL 561-278-7800 griecomazda.com</p> <p>★ 4.5 / 5.0 432 Verified Reviews Customer Favorites ♥ 5,623</p> | <p> Vehicle serviced 30,000 mile service performed 90,000 mile service performed Cabin air filter replaced/cleaned</p> |
| 05/29/2014 94,055 | <p>Grieco Mazda Delray Beach, FL 561-278-7800 griecomazda.com</p> <p>★ 4.5 / 5.0 432 Verified Reviews Customer Favorites ♥ 5,623</p> | <p> Vehicle serviced Battery/charging system checked Brakes checked Tire condition and pressure checked</p> |
| 09/25/2014 96,691 | <p>Grieco Mazda Delray Beach, FL 561-278-7800 griecomazda.com</p> <p>★ 4.5 / 5.0 432 Verified Reviews Customer Favorites ♥ 5,623</p> | <p> Vehicle serviced Maintenance inspection completed 30,000 mile service performed Brakes checked Tire(s) balanced Tire condition and pressure checked Tires rotated Battery/charging system checked Four wheel alignment performed</p> |
| 11/26/2014 98,081 | <p>Grieco Mazda Delray Beach, FL 561-278-7800 griecomazda.com</p> <p>★ 4.5 / 5.0 432 Verified Reviews Customer Favorites ♥ 5,623</p> | <p> Vehicle serviced Maintenance inspection completed Alignment checked Battery/charging system checked Brakes checked Antifreeze/coolant flushed/changed Tire condition and pressure checked</p> |

| | | | |
|--------------------|---|---|--|
| 03/28/2015 100,311 | Grieco Mazda Delray Beach, FL 561-278-7800 griecomazda.com |  | Vehicle serviced Maintenance inspection completed 5,000 mile service performed 30,000 mile service performed Brakes checked Tire(s) balanced Tire condition and pressure checked Battery/charging system checked |
| | ★ 4.5 / 5.0 432 Verified Reviews Customer Favorites ❤️ 5,623 | | |
| 04/18/2015 100,738 | Grieco Mazda Delray Beach, FL 561-278-7800 griecomazda.com |  | Vehicle serviced Maintenance inspection completed Alignment checked Battery/charging system checked Brakes checked Tire condition and pressure checked |
| | ★ 4.5 / 5.0 432 Verified Reviews Customer Favorites ❤️ 5,623 | | |
| 06/27/2015 102,350 | Grieco Mazda Delray Beach, FL 561-278-7800 griecomazda.com |  | Vehicle serviced Maintenance inspection completed Four wheel alignment performed Alignment performed Battery/charging system checked Cabin air filter replaced/cleaned Tire condition and pressure checked One tire mounted Front wiper blades/refills replaced |
| | ★ 4.5 / 5.0 432 Verified Reviews Customer Favorites ❤️ 5,623 | | |
| 09/03/2015 | Florida Motor Vehicle Dept. Boca Raton, FL Title #0107629575 | | Registration issued or renewed Titled or registered as personal vehicle Vehicle color noted as Silver |
| 10/16/2015 104,586 | Grieco Mazda Delray Beach, FL 561-278-7800 griecomazda.com |  | Vehicle serviced Maintenance inspection completed 15,000 mile service performed Four wheel alignment performed Alignment performed Battery/charging system checked Brakes checked Four tires mounted Tire condition and pressure checked |
| | ★ 4.5 / 5.0 432 Verified Reviews Customer Favorites ❤️ 5,623 | | |
| 03/21/2016 107,610 | Grieco Mazda Delray Beach, FL 561-278-7800 griecomazda.com |  | Vehicle serviced Maintenance inspection completed 5,000 mile service performed 30,000 mile service performed Battery/charging system checked Brakes checked Tire condition and pressure checked |
| | ★ 4.5 / 5.0 432 Verified Reviews Customer Favorites ❤️ 5,623 | | |

| | | | |
|--------------------|---|---|---|
| 08/13/2016 111,316 | <p>Grieco Mazda Delray Beach, FL 561-278-7800 griecomazda.com</p> |  | <p>Vehicle serviced Maintenance inspection completed 5,000 mile service performed 30,000 mile service performed Battery/charging system checked Brakes checked Four wheel alignment performed Cabin air filter replaced/cleaned Tire condition and pressure checked</p> |
| 10/15/2016 112,482 | <p>Grieco Mazda Delray Beach, FL 561-278-7800 griecomazda.com</p> |  | <p>Vehicle serviced Maintenance inspection completed Battery/charging system checked Brakes checked Tire condition and pressure checked</p> |
| 12/19/2016 114,143 | <p>Grieco Mazda Delray Beach, FL 561-278-7800 griecomazda.com</p> |  | <p>Vehicle serviced Maintenance inspection completed Battery/charging system checked Brakes checked Tire condition and pressure checked</p> |
| 03/25/2017 115,863 | <p>Grieco Mazda Delray Beach, FL 561-278-7800 griecomazda.com</p> |  | <p>Vehicle serviced Maintenance inspection completed 5,000 mile service performed 30,000 mile service performed Battery/charging system checked Body electrical system checked Brakes checked Oil and filter changed Fuel injection system flushed/serviced Engine mount(s) replaced Air filter replaced Tire condition and pressure checked</p> |
| 09/01/2017 | <p>Florida Motor Vehicle Dept. Delray Beach, FL Title #0107629575</p> | | <p>Registration issued or renewed Titled or registered as personal vehicle Registration updated when owner moved the vehicle to a new location Vehicle color noted as Silver</p> |

09/07/2017 121,469 Mazda of South
Charlotte
Pineville, NC
980-224-4225
mazdaofsouthcharlotte.
com

★ 4.8 / 5.0
987 Verified Reviews
♥ 11,187 Customer
Favorites



Vehicle serviced

Maintenance inspection completed
Brakes checked
Front strut(s) replaced
Steering/suspension checked

11/10/2017

Damage Report



Accident reported: minor damage





Vehicle involved in a rear-end
collision with another motor vehicle
Damage to front
Airbags did not deploy

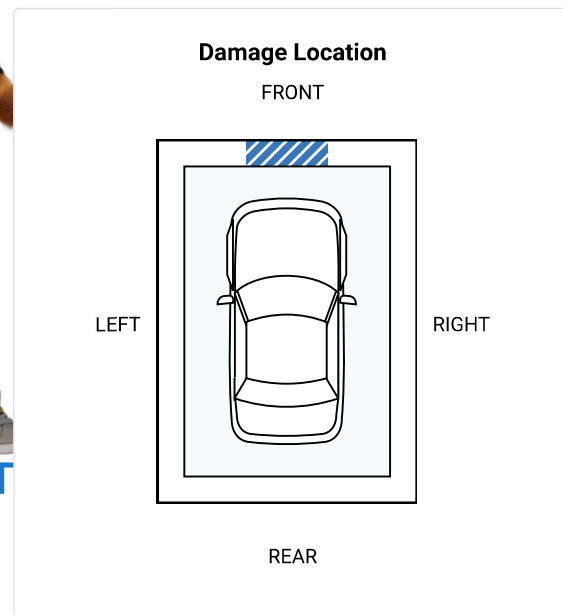
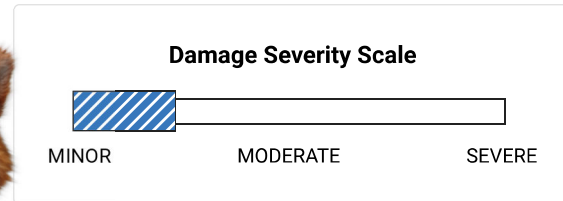

**CARFAX HAS THE MOST
ACCIDENT & DAMAGE
INFORMATION**



Minor damage is usually cosmetic, including
dents or scratches to the vehicle body.

| | | |
|--------------------|--|--|
| 11/11/2017 124,423 | <p>Grieco Mazda Delray Beach, FL 561-278-7800 griecomazda.com</p> <p>★ 4.5 / 5.0 432 Verified Reviews Customer Favorites ♥ 5,623</p> | <p> Vehicle serviced Maintenance inspection completed Battery/charging system checked Brakes checked Four wheel alignment performed Tire(s) balanced Tire condition and pressure checked Tires rotated</p> |
| 02/10/2018 127,245 | <p>Grieco Mazda Delray Beach, FL 561-278-7800 griecomazda.com</p> <p>★ 4.5 / 5.0 432 Verified Reviews Customer Favorites ♥ 5,623</p> | <p> Vehicle serviced Maintenance inspection completed Oil and filter changed Engine checked Four wheel alignment performed Steering/suspension checked</p> |
| 08/04/2018 133,903 | <p>Grieco Mazda Delray Beach, FL 561-278-7800 griecomazda.com</p> <p>★ 4.5 / 5.0 432 Verified Reviews Customer Favorites ♥ 5,623</p> | <p> Vehicle serviced Maintenance inspection completed 60,000 mile service performed Battery/charging system checked Brakes checked Tire condition and pressure checked Four tires mounted Four wheel alignment performed</p> |
| 09/17/2018 135,117 | <p>Grieco Mazda Delray Beach, FL 561-278-7800 griecomazda.com</p> <p>★ 4.5 / 5.0 432 Verified Reviews Customer Favorites ♥ 5,623</p> | <p> Vehicle serviced Maintenance inspection completed Battery/charging system checked Brakes checked Tire condition and pressure checked</p> |
| 06/25/2019 | Damage Report | <p> Damage reported: minor damage Damage to front</p> |



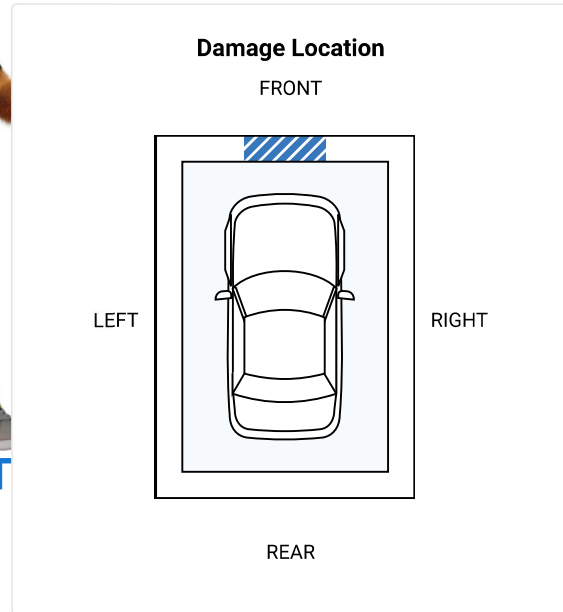
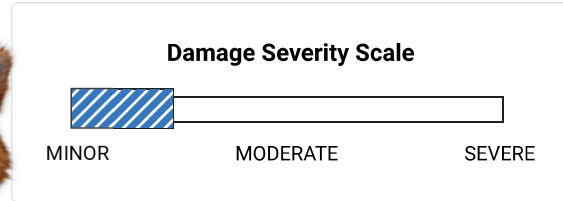

CARFAX HAS THE MOST ACCIDENT & DAMAGE INFORMATION



Minor damage is usually cosmetic, including dents or scratches to the vehicle body.

| | | |
|--------------------|---|--|
| 06/29/2019 137,039 | Grieco Mazda Delray Beach, FL 561-278-7800 griecomazda.com ★ 4.5 / 5.0 432 Verified Reviews ❤️ 5,623 Customer Favorites |  Vehicle serviced Maintenance inspection completed 5,000 mile service performed 30,000 mile service performed Battery/charging system checked Tire condition and pressure checked |
| 09/09/2019 | Florida Motor Vehicle Dept. Delray Beach, FL Title #0107629575 | Registration issued or renewed Titled or registered as personal vehicle Vehicle color noted as Silver |
| 08/07/2020 | Florida Motor Vehicle Dept. Delray Beach, FL Title #0107629575 | Registration issued or renewed Titled or registered as personal vehicle Vehicle color noted as Silver |

| | | | | |
|------------|---------|--|---|--|
| 12/28/2021 | 137,711 | Grieco Mazda Delray Beach, FL 561-278-7800 griecomazda.com ★ 4.5 / 5.0 432 Verified Reviews ♥ 5,623 Customer Favorites |  | Vehicle serviced Maintenance inspection completed Battery replaced Antifreeze/coolant checked Oil and filter changed Brakes checked |
| 08/10/2022 | | Florida Motor Vehicle Dept. Delray Beach, FL Title #0107629575 | | Registration issued or renewed Titled or registered as personal vehicle Vehicle color noted as Silver |
| 03/24/2023 | 138,158 | Grieco Mazda Delray Beach, FL 561-278-7800 griecomazda.com ★ 4.5 / 5.0 432 Verified Reviews ♥ 5,623 Customer Favorites |  | Vehicle serviced Maintenance inspection completed Battery replaced Battery/charging system checked Brakes checked Oil and filter changed Alignment performed Tires rotated Tire condition and pressure checked Four tires balanced |

Have Questions? Consumers, please visit our Help Center at www.carfax.com. Dealers or Subscribers, please visit our Help Center at www.carfaxonline.com.



Glossary

Accident Indicator

CARFAX receives information about accidents in all 50 states, the District of Columbia and Canada.

Not every accident is reported to CARFAX. As details about the accident become available, those additional details are added to the CARFAX Vehicle History Report. CARFAX recommends that you have this vehicle inspected by a qualified mechanic.

- According to the National Safety Council, Injury Facts, 2021 edition, 5% of the 276 million registered vehicles in the U.S. were involved in an accident in 2019. Over 77% of these were considered minor or moderate.
- This CARFAX Vehicle History Report is based only on information supplied to CARFAX and available as of 1/13/24 at 7:24:29 AM (CST). Other information about this vehicle, including problems, may not have been reported to CARFAX. Use this report as one important tool, along with a vehicle inspection and test drive, to make a better decision about your next used car.

Damage Indicator

Damage can be a result of many different types of events. Examples include contact with objects (other cars, trees, traffic signs, road debris, etc), vandalism, or weather-related events. Not every damage event is reported to CARFAX. As details about the damage event become available, those additional details are added to the CARFAX Vehicle History Report. CARFAX recommends that you have this vehicle inspected by a qualified mechanic.

- This CARFAX Vehicle History Report is based only on information supplied to CARFAX and available as of 1/13/24 at 7:24:29 AM (CST). Other information about this vehicle, including problems, may not have been reported to CARFAX. Use this report as one important tool, along with a vehicle inspection and test drive, to make a better decision about your next used car.

Damage Severity

Damage events result in one of the following severity levels:

- **Minor:** Generally, minor damage is cosmetic (including dents or scratches), may only require reconditioning, and typically does not compromise a vehicle's operation and/or safety.
- **Moderate:** Moderate damage may affect multiple components of the vehicle and may impair the vehicle's operation and/or safety.
- **Severe:** Severe damage usually affects multiple components of the vehicle and is likely to compromise the vehicle's operation and/or safety.

CARFAX recommends getting a pre-purchase inspection at a certified collision repair facility.

First Owner

When the first owner(s) obtains a title from a Department of Motor Vehicles as proof of ownership.

New Owner Reported

When a vehicle is sold to a new owner, the Title must be transferred to the new owner(s) at a Department of Motor Vehicles.

Ownership History

CARFAX defines an owner as an individual or business that possesses and uses a vehicle. Not all title transactions represent changes in ownership. To provide estimated number of owners, CARFAX proprietary technology analyzes all the events in a vehicle history. Estimated ownership is available for vehicles manufactured after 1991 and titled solely in the US including Puerto Rico. Dealers sometimes opt to take ownership of a vehicle and are required to in the following states: Maine, Massachusetts, New Jersey, Ohio, Oklahoma, Pennsylvania and South Dakota. Please consider this as you review a vehicle's estimated ownership history.

Title Issued

A state issues a title to provide a vehicle owner with proof of ownership. Each title has a unique number. Each title or registration record on a CARFAX report does not necessarily indicate a change in ownership. In Canada, a registration and bill of sale are used as proof of ownership.

Follow Us:



facebook.com/CARFAX



[@CARFAXinc](https://twitter.com/CARFAXinc)



[About CARFAX](#)

CARFAX DEPENDS ON ITS SOURCES FOR THE ACCURACY AND RELIABILITY OF ITS INFORMATION. THEREFORE, NO RESPONSIBILITY IS ASSUMED BY CARFAX OR ITS AGENTS FOR ERRORS OR OMISSIONS IN THIS REPORT. CARFAX FURTHER EXPRESSLY DISCLAIMS ALL WARRANTIES, EXPRESS OR IMPLIED, INCLUDING ANY IMPLIED WARRANTIES OF MERCHANTABILITY OR FITNESS FOR A PARTICULAR PURPOSE.

© 2024 CARFAX, Inc., part of S&P Global. All rights reserved.
1/13/24 7:24:29 AM (CST)

I have reviewed and received a copy of the CARFAX Vehicle History Report for this 2007 MAZDA MAZDA3 vehicle (VIN: JM1BK323071735903), which is based on information supplied to CARFAX and available as of 1/13/24 at 8:24 AM (EST).

Customer Signature

Date

Dealer Signature

Date