



Report

US \$44.99

2011 Ford Escape XLT

165,857 mi | VIN: 1FMCU0DG8BKA32769 |

4 Door Wagon/Sport Utility | 3.0L V6 F DOHC 24V | Flex Fuel | Front wheel drive



ACCIDENT

Total Loss Vehicle

43 Service history records

5 Previous owners

Personal vehicle

Last owned in Michigan

82 Detailed records available

This CARFAX Vehicle History Report is based only on information supplied to CARFAX and available as of 4/6/26 at 3:06:23 PM (CDT). Other information about this vehicle, including problems, may not have been reported to CARFAX. Use this report as one important tool, along with a vehicle inspection and test drive, to make a better decision about your next used car.



Accident / Damage History

Not all accidents / issues are reported to CARFAX

Event 1

06/06/2015

Accident reported: minor damage with another motor vehicle

Damage Severity Scale

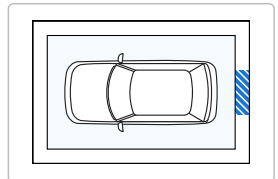
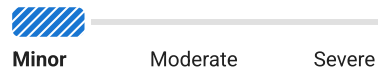

Event 2

03/02/2017

Damage reported: minor damage

Damage Severity Scale

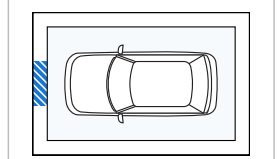
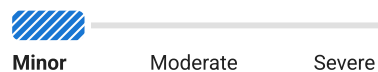

Event 3

01/29/2019

Damage reported: minor damage

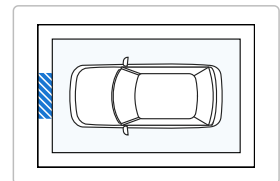
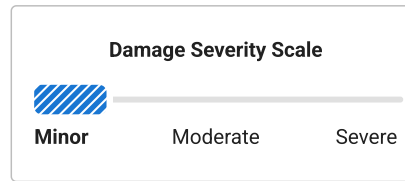

Event 4

03/09/2021

Accident reported: minor damage with another motor vehicle

- Disabling damage reported
- Vehicle towed
- Airbags did not deploy

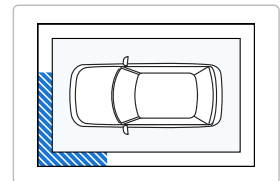
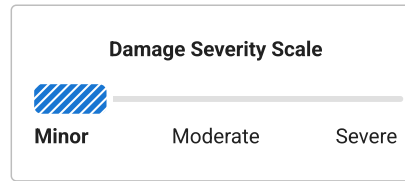

Event 5

03/09/2021

TOTAL LOSS VEHICLE

- Vehicle declared a total loss by an insurance company
- Collision damage reported



Recent Service Highlights

Key services performed in the last 12 months

Service	Comments	Date
Brakes	<ul style="list-style-type: none"> ✓ Brake rotor(s) replaced ✓ Front brake caliper(s) replaced ✓ Front brake pads replaced ✓ Front brake rotor(s) replaced 	05/14/2025

This car has been recently serviced. That's a good thing!



Additional History

Not all accidents / issues are reported to CARFAX

	Owners 1-3	Owner 4	Owner 5
Total Loss Total Loss Reported: 03/09/2021.	Total Loss Reported	No New Issues Reported	No New Issues Reported
Structural Damage CARFAX recommends that you have this vehicle inspected by a collision repair specialist.	<input checked="" type="checkbox"/> No Issues Reported	<input checked="" type="checkbox"/> No Issues Reported	<input checked="" type="checkbox"/> No Issues Reported
Airbag Deployment No airbag deployment reported to CARFAX.	<input checked="" type="checkbox"/> No Issues Reported	<input checked="" type="checkbox"/> No Issues Reported	<input checked="" type="checkbox"/> No Issues Reported
Odometer Check No indication of an odometer rollback.	<input checked="" type="checkbox"/> No Issues Indicated	<input checked="" type="checkbox"/> No Issues Indicated	<input checked="" type="checkbox"/> No Issues Indicated
Accident / Damage Accidents reported: 06/06/2015 and 03/09/2021. Damage reported: 03/02/2017 and 01/29/2019.	Accident Reported	No New Issues Reported	No New Issues Reported

Manufacturer Recall No open recalls reported to CARFAX. A current list of recalls is available at Ford Motor Company.	<input checked="" type="checkbox"/> No Recalls Reported	<input checked="" type="checkbox"/> No Recalls Reported	<input checked="" type="checkbox"/> No Recalls Reported
Basic Warranty Original warranty estimated to have expired.	Warranty Expired	Warranty Expired	Warranty Expired

 Title History CARFAX guarantees the information in this section	<input type="person"/> Owners 1-3	<input type="person"/> Owner 4	<input type="person"/> Owner 5
Damage Brands Salvage Junk Rebuilt Fire Flood Hail Lemon	<input checked="" type="checkbox"/> Guaranteed No Problem	<input checked="" type="checkbox"/> Guaranteed No Problem	<input checked="" type="checkbox"/> Guaranteed No Problem
Odometer Brands Not Actual Mileage Exceeds Mechanical Limits	<input checked="" type="checkbox"/> Guaranteed No Problem	<input checked="" type="checkbox"/> Guaranteed No Problem	<input checked="" type="checkbox"/> Guaranteed No Problem









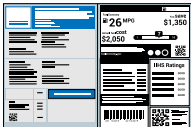









GUARANTEED - None of these title problems were reported by a U.S. state Department of Motor Vehicles (DMV). If you find that any of these title problems were reported by a DMV and not included in this report, you may qualify. [View Terms](#) | [View Certificate](#)

 Ownership History The number of owners is estimated	<input type="person"/> Owners 1-3	<input type="person"/> Owner 4	<input type="person"/> Owner 5
Year purchased	2010	2022	2023
Type of owner	Personal	Personal	Personal
Estimated length of ownership	12 yrs. 1 mo.	10 months	2 yrs. 6 mo.
Owned in the following states/provinces	See Details	Michigan	Michigan
Estimated miles driven per year	See Details	---	---
Last reported odometer reading	114,200	115,200	165,857

Detailed History

<input type="person"/> Owner 1 Purchased: 2010	Personal Vehicle 10,932 mi/yr		
Date	Mileage	Source	Comments
09/02/2010		Ford Motor Company	Vehicle manufactured and shipped to original dealer Original Window Sticker 
09/14/2010		Dealer Inventory Ann Arbor, MI	Vehicle offered for sale
09/18/2010		Varsity Ford Ann Arbor, MI 888-538-1723 varsityford.com ★ 4.7 / 5.0 316 Verified Reviews ❤️ 3,366 Customer Favorites	Vehicle sold
09/18/2010	16	Michigan Motor Vehicle Dept. Ann Arbor, MI Title #603Y2610316	Title or registration issued - First owner reported - Titled or registered as personal vehicle

09/24/2010		Varsity Ford Ann Arbor, MI 888-538-1723 varsityford.com ★ 4.7 / 5.0 316 Verified Reviews ♥ 3,366 Customer Favorites		Vehicle serviced - Pre-delivery inspection completed
03/17/2011	4,468	Varsity Ford Ann Arbor, MI 888-538-1723 varsityford.com ★ 4.7 / 5.0 316 Verified Reviews ♥ 3,366 Customer Favorites		Vehicle serviced - Maintenance inspection completed - Battery/charging system checked - Oil and filter changed
06/22/2011		Michigan Motor Vehicle Dept. Ann Arbor, MI		Registration issued or renewed
07/28/2011	9,946	Varsity Ford Ann Arbor, MI 888-538-1723 varsityford.com ★ 4.7 / 5.0 316 Verified Reviews ♥ 3,366 Customer Favorites		Vehicle serviced - Maintenance inspection completed - Battery/charging system checked - Oil and filter changed - Tires rotated
10/10/2011	13,335	Varsity Ford Ann Arbor, MI 888-538-1723 varsityford.com ★ 4.7 / 5.0 316 Verified Reviews ♥ 3,366 Customer Favorites		Vehicle serviced - Maintenance inspection completed - Battery/charging system checked - Oil and filter changed
03/01/2012	18,275	Varsity Ford Ann Arbor, MI 888-538-1723 varsityford.com ★ 4.7 / 5.0 316 Verified Reviews ♥ 3,366 Customer Favorites		Vehicle serviced - Maintenance inspection completed - Battery/charging system checked - Oil and filter changed - Tires rotated
03/13/2012		Michigan Motor Vehicle Dept. Ann Arbor, MI		Registration issued or renewed
04/03/2012	19,383	Varsity Ford Ann Arbor, MI 888-538-1723 varsityford.com ★ 4.7 / 5.0 316 Verified Reviews ♥ 3,366 Customer Favorites		Vehicle serviced
06/23/2012	22,214	Varsity Ford Ann Arbor, MI 888-538-1723 varsityford.com ★ 4.7 / 5.0 316 Verified Reviews ♥ 3,366 Customer Favorites		Vehicle serviced
06/26/2012		Michigan Motor Vehicle Dept. Ann Arbor, MI		Registration issued or renewed
07/31/2012	23,645	Varsity Ford Ann Arbor, MI 888-538-1723 varsityford.com ★ 4.7 / 5.0 316 Verified Reviews ♥ 3,366 Customer Favorites		Vehicle serviced - Maintenance inspection completed - Battery/charging system checked - Oil and filter changed - Tires rotated

11/29/2012	28,197	Varsity Ford Ann Arbor, MI 888-538-1723 varsityford.com ★ 4.7 / 5.0 316 Verified Reviews ♥ 3,366 Customer Favorites		Vehicle serviced - Maintenance inspection completed - Battery/charging system checked - Oil and filter changed - Tires rotated - Vehicle washed/detailed
05/17/2013	32,785	Varsity Ford Ann Arbor, MI 888-538-1723 varsityford.com ★ 4.7 / 5.0 316 Verified Reviews ♥ 3,366 Customer Favorites		Vehicle serviced - Maintenance inspection completed - Battery/charging system checked - Oil and filter changed - Tires rotated - Vehicle washed/detailed
06/28/2013		Michigan Motor Vehicle Dept. Ann Arbor, MI		Registration issued or renewed
09/26/2013	36,666	Varsity Ford Ann Arbor, MI 888-538-1723 varsityford.com ★ 4.7 / 5.0 316 Verified Reviews ♥ 3,366 Customer Favorites		Vehicle serviced - Maintenance inspection completed - Battery/charging system checked - Vehicle washed/detailed
02/10/2014	40,019	Varsity Ford Ann Arbor, MI 888-538-1723 varsityford.com ★ 4.7 / 5.0 316 Verified Reviews ♥ 3,366 Customer Favorites		Vehicle serviced - Maintenance inspection completed - Battery/charging system checked - Drivability/performance checked
03/07/2014	40,562	Varsity Ford Ann Arbor, MI 888-538-1723 varsityford.com ★ 4.7 / 5.0 316 Verified Reviews ♥ 3,366 Customer Favorites		Vehicle serviced - Maintenance inspection completed - Battery/charging system checked - Oil and filter changed - Tires rotated - Transmission fluid flushed - Vehicle washed/detailed
07/14/2014		Michigan Motor Vehicle Dept. Ann Arbor, MI		Registration issued or renewed
07/25/2014	44,894	Varsity Ford Ann Arbor, MI 888-538-1723 varsityford.com ★ 4.7 / 5.0 316 Verified Reviews ♥ 3,366 Customer Favorites		Vehicle serviced - Maintenance inspection completed - Battery/charging system checked - Oil and filter changed - Tires rotated - Vehicle washed/detailed
10/28/2014	49,479	Varsity Ford Ann Arbor, MI 888-538-1723 varsityford.com ★ 4.7 / 5.0 316 Verified Reviews ♥ 3,366 Customer Favorites		Vehicle serviced - Maintenance inspection completed - Battery/charging system checked - Drivability/performance checked - Oil and filter changed - Vehicle washed/detailed
03/11/2015	54,304	Varsity Ford Ann Arbor, MI 888-538-1723 varsityford.com ★ 4.7 / 5.0 316 Verified Reviews ♥ 3,366 Customer Favorites		Vehicle serviced - Maintenance inspection completed - Battery/charging system checked - Oil and filter changed
03/23/2015		Varsity Ford Ann Arbor, MI 888-538-1723 varsityford.com		Vehicle serviced

★ 4.7 / 5.0 316 Verified Reviews

♥ 3,366 Customer Favorites

06/06/2015

Damage Report

Accident reported: minor damage with another motor vehicle

- Damage to rear

Damage Severity Scale



Minor

Moderate

Severe

Damage Location

FRONT

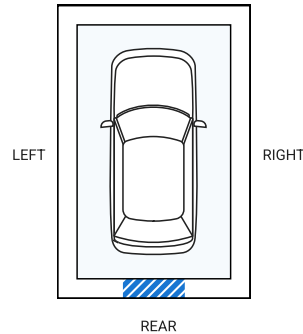

CARFAX HAS THE MOST ACCIDENT & DAMAGE INFORMATION



06/24/2015

Michigan
Motor Vehicle Dept.
Ann Arbor, MI

Registration issued or renewed

07/23/2015

58,296

Varsity Ford
Ann Arbor, MI
888-538-1723
varsityford.com
★ 4.7 / 5.0 316 Verified Reviews
♥ 3,366 Customer Favorites



Vehicle serviced

- Maintenance inspection completed
- Battery/charging system checked
- Sway bar link(s) replaced
- Vehicle washed/detailed

09/30/2015

60,933

Varsity Ford
Ann Arbor, MI
888-538-1723
varsityford.com
★ 4.7 / 5.0 316 Verified Reviews
♥ 3,366 Customer Favorites



Vehicle serviced

- Alignment performed
- Four wheel alignment performed
- Lower control arm(s) replaced
- Vehicle washed/detailed

12/01/2015

62,794

Varsity Ford
Ann Arbor, MI
888-538-1723
varsityford.com
★ 4.7 / 5.0 316 Verified Reviews
♥ 3,366 Customer Favorites



Vehicle serviced

- Maintenance inspection completed
- Recommended maintenance performed
- Battery/charging system checked
- Transmission fluid changed
- Transmission fluid flushed
- Vehicle washed/detailed

04/21/2016

67,198

Varsity Ford
Ann Arbor, MI
888-538-1723
varsityford.com
★ 4.7 / 5.0 316 Verified Reviews
♥ 3,366 Customer Favorites



Vehicle serviced

- Maintenance inspection completed
- Lower control arm(s) replaced
- Oil and filter changed
- Tires rotated
- Vehicle washed/detailed

06/27/2016

Michigan
Motor Vehicle Dept.
Ann Arbor, MI

Registration issued or renewed

08/19/2016

72,010

Varsity Ford
Ann Arbor, MI
888-538-1723



Vehicle serviced

- Maintenance inspection completed
- Air filter replaced

varsityford.com
 ★ 4.7 / 5.0 316 Verified Reviews
 ❤️ 3,366 Customer Favorites

- Brake fluid flushed/changed
- Engine/powertrain computer/module checked
- Oil and filter changed
- Tires rotated
- Vehicle washed/detailed

09/15/2016 72,916

Varsity Ford
 Ann Arbor, MI
 888-538-1723
 varsityford.com
 ★ 4.7 / 5.0 316 Verified Reviews
 ❤️ 3,366 Customer Favorites



Vehicle serviced
 - Vehicle washed/detailed

12/21/2016 76,563

Varsity Ford
 Ann Arbor, MI
 888-538-1723
 varsityford.com
 ★ 4.7 / 5.0 316 Verified Reviews
 ❤️ 3,366 Customer Favorites



Vehicle serviced
 - Maintenance inspection completed
 - Antifreeze/coolant flushed/changed
 - Oil and filter changed
 - Tire condition and pressure checked
 - Tires rotated
 - Vehicle washed/detailed

02/04/2017 78,278

Varsity Ford
 Ann Arbor, MI
 888-538-1723
 varsityford.com
 ★ 4.7 / 5.0 316 Verified Reviews
 ❤️ 3,366 Customer Favorites



Vehicle serviced
 - Maintenance inspection completed
 - Vehicle washed/detailed

03/02/2017

Damage Report

Damage reported: minor damage
 - Damage to front

**CARFAX HAS THE MOST
 ACCIDENT & DAMAGE
 INFORMATION**

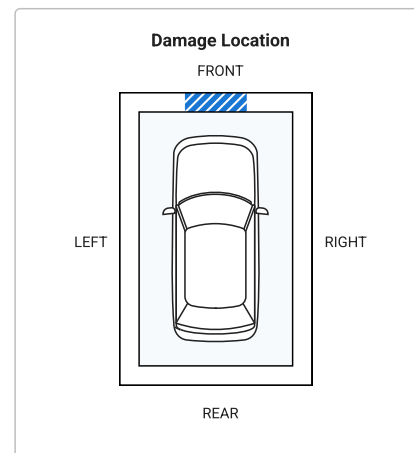
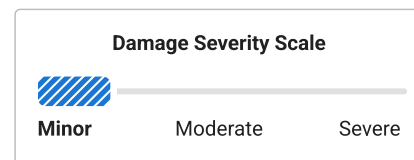

04/27/2017 80,789

Varsity Ford
 Ann Arbor, MI
 888-538-1723
 varsityford.com
 ★ 4.7 / 5.0 316 Verified Reviews
 ❤️ 3,366 Customer Favorites



Vehicle serviced
 - Maintenance inspection completed
 - Oil and filter changed
 - Tires rotated
 - Vehicle washed/detailed

06/30/2017

Michigan
 Motor Vehicle Dept.
 Ann Arbor, MI







Registration issued or renewed

12/18/2017 89,504

Meineke #2649
 Ann Arbor, MI
 734-619-0380
 ★ 4.9 / 5.0 38 Verified Reviews



Vehicle serviced
 - Air filter replaced
 - Oil and filter changed
 - Tires rotated





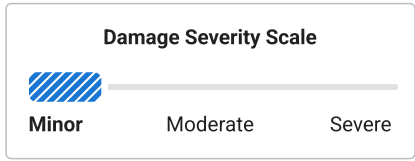

01/26/2018	90,192	Varsity Ford Ann Arbor, MI 888-538-1723 varsityford.com ★ 4.7 / 5.0 316 Verified Reviews ♥ 3,366 Customer Favorites		Vehicle serviced - Maintenance inspection completed - Vehicle washed/detailed
04/09/2018	91,209	Meineke #2649 Ann Arbor, MI 734-619-0380 ★ 4.9 / 5.0 38 Verified Reviews		Vehicle serviced - Antifreeze/coolant flushed/changed - Cooling system checked - Oil and filter changed - Tires rotated
06/04/2018	92,705	Varsity Ford Ann Arbor, MI 888-538-1723 varsityford.com ★ 4.7 / 5.0 316 Verified Reviews ♥ 3,366 Customer Favorites		Vehicle serviced - Maintenance inspection completed - Vehicle washed/detailed
07/09/2018		Michigan Motor Vehicle Dept. Ann Arbor, MI		Registration issued or renewed
07/23/2018	94,050	Meineke #2649 Ann Arbor, MI 734-619-0380 ★ 4.9 / 5.0 38 Verified Reviews		Vehicle serviced - Oil and filter changed
09/18/2018	96,228	Varsity Ford Ann Arbor, MI 888-538-1723 varsityford.com ★ 4.7 / 5.0 316 Verified Reviews ♥ 3,366 Customer Favorites		Vehicle serviced - Maintenance inspection completed - Engine/powertrain computer/module checked - Vehicle washed/detailed
12/06/2018	98,245	Meineke #2649 Ann Arbor, MI 734-619-0380 ★ 4.9 / 5.0 38 Verified Reviews		Vehicle serviced - Antifreeze/coolant flushed/changed - Brake fluid flushed/changed - Cooling system checked - Fluids checked - Fuel injection system flushed/serviced - Induction system serviced - Oil and filter changed - Transmission fluid changed

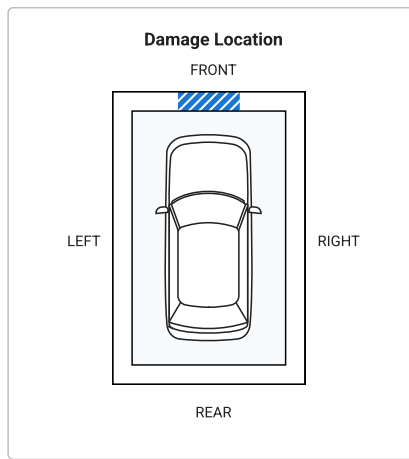
01/29/2019		Damage Report		Damage reported: minor damage - Damage to front
------------	--	---------------	--	---



CARFAX HAS THE MOST ACCIDENT & DAMAGE INFORMATION



02/28/2019	100,290	Varsity Ford Ann Arbor, MI 888-538-1723 varsityford.com ★ 4.7 / 5.0 316 Verified Reviews ♥ 3,366 Customer Favorites		Vehicle serviced - Maintenance inspection completed - Brake fluid flushed/changed - Brake rotor(s) replaced - Front brake pads replaced - Front brake rotor(s) replaced
04/08/2019	102,042	Varsity Ford Ann Arbor, MI 888-538-1723 varsityford.com ★ 4.7 / 5.0 316 Verified Reviews ♥ 3,366 Customer Favorites		Vehicle serviced - Maintenance inspection completed - Oil and filter changed - Tire condition and pressure checked - Tires rotated - Transmission fluid changed - Transmission fluid flushed - Vehicle washed/detailed
06/13/2019	104,333	Varsity Ford Ann Arbor, MI 888-996-0362 varsityford.com/ ★ 4.7 / 5.0 316 Verified Reviews ♥ 3,366 Customer Favorites		Vehicle serviced - Maintenance inspection completed - Drivability/performance checked - Vehicle washed/detailed
07/02/2019		Michigan Motor Vehicle Dept. Ann Arbor, MI		Registration issued or renewed
10/29/2019	106,485	Varsity Ford Ann Arbor, MI 888-538-1723 varsityford.com ★ 4.7 / 5.0 316 Verified Reviews ♥ 3,366 Customer Favorites		Vehicle serviced - Maintenance inspection completed - Oil and filter changed - Tire condition and pressure checked - Tires rotated - Vehicle washed/detailed
05/20/2020	109,063	Varsity Ford Ann Arbor, MI 888-538-1723 varsityford.com ★ 4.7 / 5.0 316 Verified Reviews ♥ 3,366 Customer Favorites		Vehicle serviced - Maintenance inspection completed - Oil and filter changed - Tire condition and pressure checked - Tires rotated - Vehicle washed/detailed
06/12/2020		Michigan Motor Vehicle Dept. Ann Arbor, MI		Registration issued or renewed
09/22/2020		Michigan Motor Vehicle Dept. Ann Arbor, MI		Registration issued or renewed
09/30/2020	111,369	Meineke #2649 Ann Arbor, MI 734-619-0380 ★ 4.9 / 5.0 38 Verified Reviews		Vehicle serviced - Oil and filter changed

01/08/2021 112,768 Meineke #2649
Ann Arbor, MI
734-619-0380
★ 4.9 / 5.0 38 Verified Reviews



Vehicle serviced
- Exhaust system checked
- Muffler replaced

03/09/2021 Damage Report



Accident reported: minor damage with another motor vehicle
- Damage to left front
- Damage to front
- Disabling damage reported
- Vehicle towed
- Airbags did not deploy

CARFAX HAS THE MOST ACCIDENT & DAMAGE INFORMATION



Damage Severity Scale

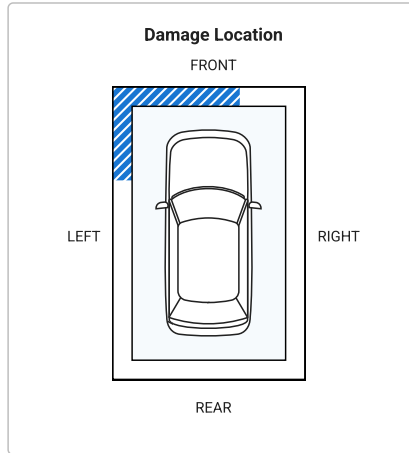
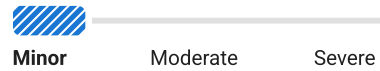

03/09/2021 Damage Report



TOTAL LOSS VEHICLE
- Vehicle declared a total loss by an insurance company
- Collision damage reported



There are many reasons an insurance company will declare a vehicle a total loss. Have this vehicle inspected by a qualified technician before you buy. [Learn More](#)

03/15/2021 Michigan Motor Vehicle Dept.
Ann Arbor, MI
Title #MI0008527765

Title issued or updated
- Duplicate title issued

03/18/2021 Michigan Motor Vehicle Dept.
Ann Arbor, MI
Title #MI0008637351

Title issued or updated
- Correction to record

05/05/2021 Michigan Motor Vehicle Dept.

Vehicle purchase reported

05/11/2021 Michigan Motor Vehicle Dept.
Dearborn Heights, MI

Registration issued or renewed

Owner 2
Purchased: 2021

Personal Vehicle

Date	Mileage	Source	Comments
05/11/2021	113,701	Michigan Motor Vehicle Dept. Dearborn Heights, MI Title #MI0009410588	Title issued or updated - New owner reported

 **Owner 3** Personal Vehicle
Purchased: 2021



Date	Mileage	Source	Comments
06/22/2021		Michigan Motor Vehicle Dept.	Vehicle purchase reported
06/25/2021	114,200	Michigan Motor Vehicle Dept. Ypsilanti, MI Title #MI0009948119	Title issued or updated - New owner reported
07/29/2021		Michigan Motor Vehicle Dept. Ypsilanti, MI	Registration issued or renewed
04/04/2022		Michigan Motor Vehicle Dept. Ypsilanti, MI	Registration issued or renewed
11/08/2022		Michigan Motor Vehicle Dept.	Vehicle purchase reported
11/15/2022		Uncle Ed's Oil Shoppe Ypsilanti, MI 734-528-4635 uncleedsoil.com ★ 4.5 / 5.0 107 Verified Reviews ❤️ 1,209 Customer Favorites	 Vehicle serviced - Oil and filter changed
11/15/2022		Michigan Motor Vehicle Dept. Ypsilanti, MI	Registration issued or renewed

 **Owner 4** Personal Vehicle
Purchased: 2022

Date	Mileage	Source	Comments
11/15/2022	115,200	Michigan Motor Vehicle Dept. Ypsilanti, MI Title #MI0015461964	Title issued or updated - New owner reported
09/18/2023		Michigan Motor Vehicle Dept.	Vehicle purchase reported
09/19/2023		Michigan Motor Vehicle Dept. Westland, MI	Registration issued or renewed

 **Owner 5** Personal Vehicle
Purchased: 2023

Date	Mileage	Source	Comments
09/19/2023		Michigan Motor Vehicle Dept. Westland, MI Title #MI0018665230	Title issued or updated - New owner reported
12/02/2024		Michigan Motor Vehicle Dept. Dearborn Heights, MI	Registration issued or renewed - Registration updated when owner moved the vehicle to a new location
01/30/2025		Michigan Motor Vehicle Dept. Dearborn Heights, MI Title #MI0024314507	Title issued or updated - Registration issued or renewed - Duplicate title issued

02/02/2025	159,088	The Plymouth Supercenter Quicklube Plymouth, MI 734-459-3500 plymouthsupercenter.com ★ 4.9 / 5.0 206 Verified Reviews ♥ 38 Customer Favorites		Vehicle serviced - Oil and filter changed
05/14/2025	165,857	Auto Tech Clinic Dearborn, MI 313-277-7200 autotechclinic.com/ ★ 4.4 / 5.0 140 Verified Reviews ♥ 313 Customer Favorites		Vehicle serviced - A/C system checked - A/C refrigerant recharged - Brakes checked - Brake rotor(s) replaced - Front brake caliper(s) replaced - Front brake hose(s) replaced - Front brake pads replaced - Front brake rotor(s) replaced - Front brakes serviced - Front wheel bearing(s)/hub(s) replaced
06/19/2025		Michigan Motor Vehicle Dept. Dearborn Heights, MI		Registration issued or renewed

Have Questions? Consumers, please visit our Help Center at www.carfax.com. Dealers or Subscribers, please visit our Help Center at www.carfaxonline.com.



Glossary

Accident Indicator

CARFAX receives information about accidents in all 50 states, the District of Columbia and Canada.

Not every accident is reported to CARFAX. As details about the accident become available, those additional details are added to the CARFAX Vehicle History Report. CARFAX recommends that you have this vehicle inspected by a qualified mechanic.

- According to the National Safety Council, Injury Facts, 2021 edition, 5% of the 276 million registered vehicles in the U.S. were involved in an accident in 2019. Over 77% of these were considered minor or moderate.
- This CARFAX Vehicle History Report is based only on information supplied to CARFAX and available as of 4/6/26 at 3:06:23 PM (CDT). Other information about this vehicle, including problems, may not have been reported to CARFAX. Use this report as one important tool, along with a vehicle inspection and test drive, to make a better decision about your next used car.

Damage Indicator

Damage can be a result of many different types of events. Examples include contact with objects (other cars, trees, traffic signs, road debris, etc), vandalism, or weather-related events. Not every damage event is reported to CARFAX. As details about the damage event become available, those additional details are added to the CARFAX Vehicle History Report. CARFAX recommends that you have this vehicle inspected by a qualified mechanic.

- This CARFAX Vehicle History Report is based only on information supplied to CARFAX and available as of 4/6/26 at 3:06:23 PM (CDT). Other information about this vehicle, including problems, may not have been reported to CARFAX. Use this report as one important tool, along with a vehicle inspection and test drive, to make a better decision about your next used car.

Damage Severity

Damage events result in one of the following severity levels:

- Minor: Generally, minor damage is cosmetic (including dents or scratches), may only require reconditioning, and typically does not compromise a vehicle's operation and/or safety.
- Moderate: Moderate damage may affect multiple components of the vehicle and may impair the vehicle's operation and/or safety.
- Severe: Severe damage usually affects multiple components of the vehicle and is likely to compromise the vehicle's operation and/or safety.

CARFAX recommends getting a pre-purchase inspection at a certified collision repair facility.

First Owner

When the first owner(s) obtains a title from a Department of Motor Vehicles as proof of ownership.

Ford or Lincoln Mercury Recall

The Ford Motor Company provides CARFAX with Field Service Action and recall information regarding safety, compliance and emissions programs announced since 2000 for a specific vehicle. For complete information regarding programs or concerns about this vehicle, please contact a local Ford or Lincoln Mercury Dealer.

New Owner Reported

When a vehicle is sold to a new owner, the Title must be transferred to the new owner(s) at a Department of Motor Vehicles.

Ownership History

CARFAX defines an owner as an individual or business that possesses and uses a vehicle. Not all title transactions represent changes in ownership. To provide estimated number of owners, CARFAX proprietary technology analyzes all the events in a vehicle history. Estimated ownership is available for vehicles manufactured after 1991 and titled solely in the US including Puerto Rico. Dealers sometimes opt to take ownership of a vehicle and are required to in the following states: Maine, Massachusetts, New Jersey, Ohio, Oklahoma, Pennsylvania and South Dakota. Please consider this as you review a vehicle's estimated ownership history.

Title Issued

A state issues a title to provide a vehicle owner with proof of ownership. Each title has a unique number. Each title or registration record on a CARFAX report does not necessarily indicate a change in ownership. In Canada, a registration and bill of sale are used as proof of ownership.

Total Loss Vehicle

An insurance or fleet company declares a vehicle a total loss when a claim exceeds approximately 75% of its pre-damage value or if the vehicle is stolen and not recovered. This damage threshold varies by company. These companies typically take possession and obtain the title. Not all total loss vehicles result in a DMV-reported branded title. This may occur when an insurance company's definition of a total loss is different than the state DMV's definition for a branded title or when the owner of the vehicle is a self-insured company, like a fleet or rental company.

Follow Us:  facebook.com/CARFAX  [@CARFAXinc](https://twitter.com/CARFAXinc)  [About CARFAX](#)

CARFAX DEPENDS ON ITS SOURCES FOR THE ACCURACY AND RELIABILITY OF ITS INFORMATION. THEREFORE, NO RESPONSIBILITY IS ASSUMED BY CARFAX OR ITS AGENTS FOR ERRORS OR OMISSIONS IN THIS REPORT. CARFAX FURTHER EXPRESSLY DISCLAIMS ALL WARRANTIES, EXPRESS OR IMPLIED, INCLUDING ANY IMPLIED WARRANTIES OF MERCHANTABILITY OR FITNESS FOR A PARTICULAR PURPOSE.

© 2026 CARFAX, Inc., part of S&P Global. All rights reserved.
4/6/26 3:06:23 PM (CDT)

I have reviewed and received a copy of the CARFAX Vehicle History Report for this 2011 FORD ESCAPE vehicle (VIN: 1FMCU0DG8BKA32769), which is based on information supplied to CARFAX and available as of 4/6/26 at 4:06 PM (EDT).

Customer Signature

Date

Dealer Signature

Date