

Display CARFAX in online listings:



This report provided free of charge by:

Nova International LLC

1919 E Kilgore Service Rd Ste 201
Kalamazoo, MI 49001

(269) 317-4803



History-Based Value Report

History events affecting this vehicle's value



1

1-Owner Vehicle



Accident Reported



Open Recall

\$15,160 Retail Value



Vehicle History Report™

US \$44.99

**2019 FORD EXPLORER
POLICE INTERCEPTOR
UTILITY**

VIN: 1FM5K8AR9KGA17428
4 DOOR WAGON/SPORT
UTILITY
3.7L V6 F DOHC 24V
GASOLINE
FRONT WHEEL DRIVE W/ 4X4
Original Window Sticker

This CARFAX Report Provided
by:
Nova International LLC



Accident reported



3 Service history records



At least 1 open recall



CARFAX 1-Owner vehicle







Last owned in Michigan



63,361 Last reported odometer reading

This CARFAX Vehicle History Report is based only on information supplied to CARFAX and available as of 1/20/24 at 7:33:23 AM (CST). Other information about this vehicle, including problems, may not have been reported to CARFAX. Use this report as one important tool, along with a vehicle inspection and test drive, to make a better decision about your next used car.

 Ownership History The number of owners is estimated		Owner 1
Year purchased		2018
Type of owner		---
Estimated length of ownership		5 yrs. 2 mo.
Owned in the following states/provinces		Michigan
Estimated miles driven per year		20,411/yr
Last reported odometer reading		63,361

 Title History CARFAX guarantees the information in this section		Owner 1
Damage Brands Salvage Junk Rebuilt Fire Flood Hail Lemon		<input checked="" type="checkbox"/> Guaranteed No Problem
Odometer Brands Not Actual Mileage Exceeds Mechanical Limits		<input checked="" type="checkbox"/> Guaranteed No Problem
 GUARANTEED - None of these title problems were reported by a U.S. state Department of Motor Vehicles (DMV). If you find that any of these title problems were reported by a DMV and not included in this report, you may qualify. View Terms View Certificate		



 Additional History Not all accidents / issues are reported to CARFAX		Owner 1
Total Loss No total loss reported to CARFAX.		<input checked="" type="checkbox"/> No Issues Reported
Structural Damage CARFAX recommends that you have this vehicle inspected by a collision repair specialist.		<input checked="" type="checkbox"/> No Issues Reported
Airbag Deployment No airbag deployment reported to CARFAX.		<input checked="" type="checkbox"/> No Issues Reported
Odometer Check No indication of an odometer rollback.		<input checked="" type="checkbox"/> No Issues Indicated
Accident / Damage Accidents reported: 03/30/2019, 05/16/2021, and 10/20/2021.		Accident Reported

Manufacturer Recall	At least 1 manufacturer recall requires service. Locate an authorized Ford or Lincoln Mercury dealer or call 866-436-7332 to obtain more information about this recall.	Recall Reported
Basic Warranty	Original warranty estimated to have expired.	Warranty Expired

CARFAX Detailed History

 **Owner 1**
Purchased: 2018

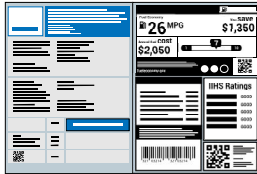
20,411 mi/yr

Date	Mileage	Source	Comments
10/17/2018		Ford Motor Company	Vehicle manufactured and shipped to original dealer  Original Window Sticker
10/19/2018	10	Signature Ford of Perry Perry, MI 800-364-2868 sigautogroup.com ★ 5.0 / 5.0 27 Verified Reviews	 Vehicle serviced Pre-delivery inspection completed
10/23/2018		Michigan Motor Vehicle Dept. East Lansing, MI Title #290G2950092	Title issued or updated First owner reported
03/30/2019		Damage Report	 Accident reported Vehicle hit while parked Damage to front

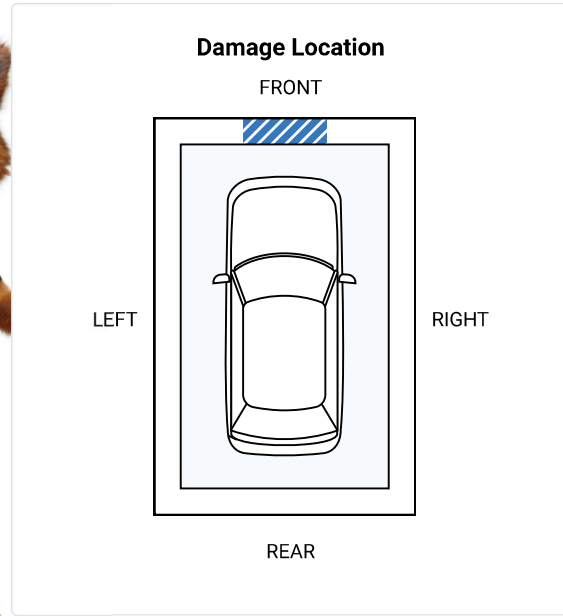

CARFAX HAS THE MOST ACCIDENT & DAMAGE INFORMATION

08/20/2019 11,425

Morrie's Ford Okemos
Okemos, MI
517-347-1830
<https://morriesokemosford.com>
/?utm_source=gmbpls&utm_medium=social&mcmid=gmbpls

★ 4.8 / 5.0
23 Verified Reviews
♥ 6 Customer Favorites



Vehicle serviced

Maintenance inspection completed
Engine serviced

05/16/2021

Damage Report



Accident reported: minor damage

It hit a curb
It hit a tree
Damage to left rear



CARFAX HAS THE MOST ACCIDENT & DAMAGE INFORMATION

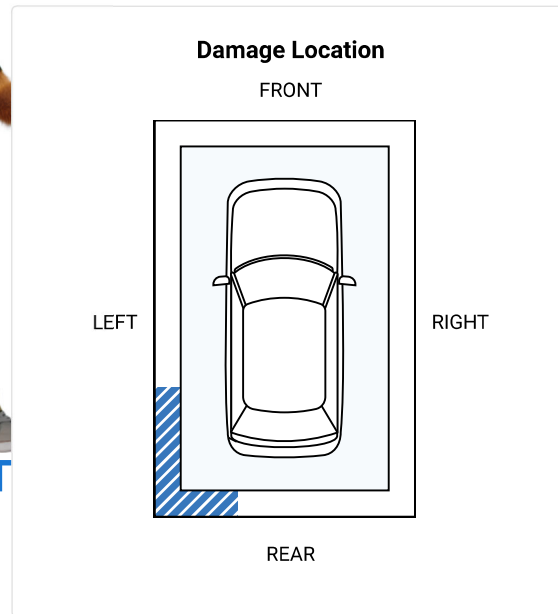
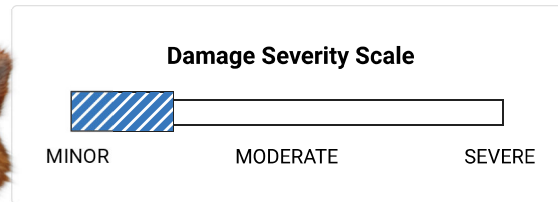

10/20/2021

Damage Report



Accident reported: minor damage
Damage to front



CARFAX HAS THE MOST ACCIDENT & DAMAGE INFORMATION

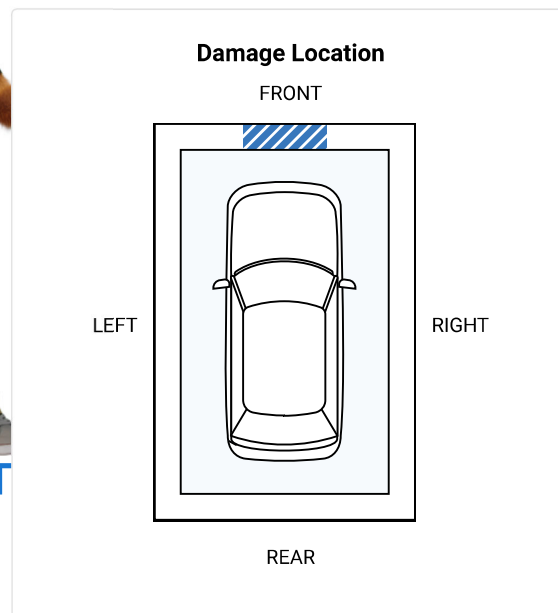
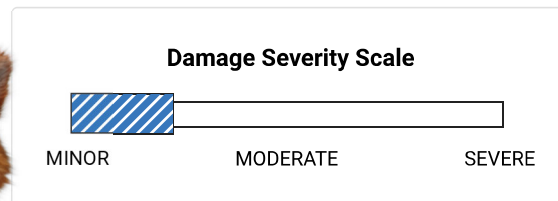

11/29/2021	63,361	Signature Ford of Perry Perry, MI 800-364-2868 sigautogroup.com ★ 5.0 / 5.0 27 Verified Reviews		Vehicle serviced Maintenance inspection completed Catalytic converter replaced Cooling system checked Exhaust manifold replaced Exhaust manifold gasket replaced Oil and filter changed
01/26/2023	Ford Motor Company	Manufacturer Emissions recall issued Recall #22E11 POWERTRAIN CONTROL MODULE PCM REPROGRAMMING Locate an authorized Ford or Lincoln dealer or call 866-436-7332 to obtain more information		

Have Questions? Consumers, please visit our Help Center at www.carfax.com. Dealers or Subscribers, please visit our Help Center at www.carfaxonline.com.



Glossary

Follow Us:



facebook.com/CARFAX



[@CARFAXinc](https://twitter.com/CARFAXinc)



About CARFAX

CARFAX DEPENDS ON ITS SOURCES FOR THE ACCURACY AND RELIABILITY OF ITS INFORMATION. THEREFORE, NO RESPONSIBILITY IS ASSUMED BY CARFAX OR ITS AGENTS FOR ERRORS OR OMISSIONS IN THIS REPORT. CARFAX FURTHER EXPRESSLY DISCLAIMS ALL WARRANTIES, EXPRESS OR IMPLIED, INCLUDING ANY IMPLIED WARRANTIES OF MERCHANTABILITY OR FITNESS FOR A PARTICULAR PURPOSE.

© 2024 CARFAX, Inc., part of S&P Global. All rights reserved.
 1/20/24 7:33:23 AM (CST)

I have reviewed and received a copy of the CARFAX Vehicle History Report for this 2019 FORD EXPLORER vehicle (VIN: 1FM5K8AR9KGA17428), which is based on information supplied to CARFAX and available as of 1/20/24 at 8:33 AM (EST).

 Customer Signature

 Date

 Dealer Signature

 Date