



## History-Based Value Report

### History events affecting this vehicle's value



Service History



Personal Vehicle



Minor Damage

**\$4,720 Retail Value**



## Vehicle History Report™

US \$44.99

### 2010 KIA OPTIMA LX

VIN: KNAGG4A85A5434700  
 SEDAN 4 DR  
 2.4L I4 F DOHC 16V  
 GASOLINE  
 FRONT WHEEL DRIVE

#### Accident reported: minor damage

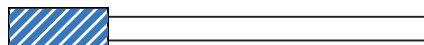

MINOR      MODERATE      SEVERE



**34** Service history records



**4** Previous owners



Personal vehicle



**140,212** Last reported odometer reading

This CARFAX Vehicle History Report is based only on information supplied to CARFAX and available as of 5/11/24 at 6:23:12 AM (CDT). Other information about this vehicle, including problems, may not have been reported to CARFAX. Use this report as one important tool, along with a vehicle inspection and test drive, to make a better decision about your next used car.

**CARFAX** Accident / Damage History

Not all accidents / issues are reported to CARFAX

Event 1

05/17/2017

**Damage reported:  
minor damage**

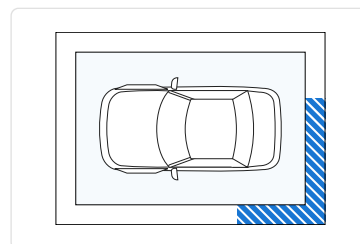
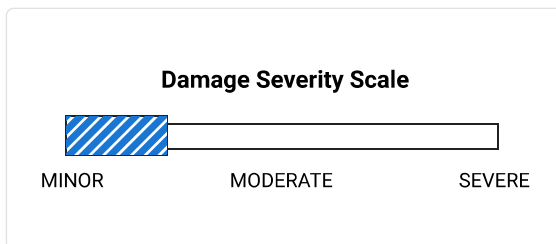

Event 2

06/04/2017

**Accident reported:  
minor damage**

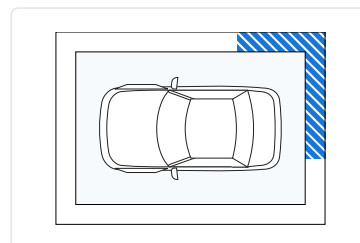
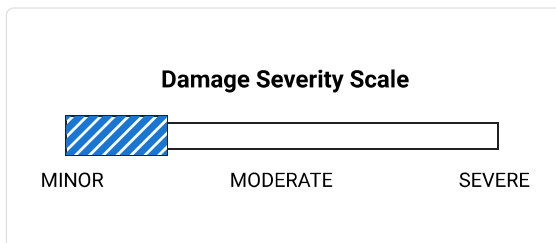



**CARFAX** Additional History

Not all accidents / issues are reported to CARFAX

	Owners 1-2	Owner 3	Owner 4
<b>Total Loss</b> No total loss reported to CARFAX.	<input checked="" type="checkbox"/> No Issues Reported	<input checked="" type="checkbox"/> No Issues Reported	<input checked="" type="checkbox"/> No Issues Reported
<b>Structural Damage</b> CARFAX recommends that you have this vehicle inspected by a collision repair specialist.	<input checked="" type="checkbox"/> No Issues Reported	<input checked="" type="checkbox"/> No Issues Reported	<input checked="" type="checkbox"/> No Issues Reported
<b>Airbag Deployment</b> No airbag deployment reported to CARFAX.	<input checked="" type="checkbox"/> No Issues Reported	<input checked="" type="checkbox"/> No Issues Reported	<input checked="" type="checkbox"/> No Issues Reported
<b>Odometer Check</b> No indication of an odometer rollback.	<input checked="" type="checkbox"/> No Issues Indicated	<input checked="" type="checkbox"/> No Issues Indicated	<input checked="" type="checkbox"/> No Issues Indicated





<b>Accident / Damage</b> Damage reported: 05/17/2017. Accident reported: 06/04/2017.	<input checked="" type="checkbox"/> No Issues Reported	Minor Damage	No New Issues Reported
<b>Manufacturer Recall</b> No open recalls reported to CARFAX.	<input checked="" type="checkbox"/> No Recalls Reported	<input checked="" type="checkbox"/> No Recalls Reported	<input checked="" type="checkbox"/> No Recalls Reported
<b>Basic Warranty</b> Original warranty estimated to have expired.	<b>Warranty Expired</b>	<b>Warranty Expired</b>	<b>Warranty Expired</b>





 <b>Title History</b> CARFAX guarantees the information in this section	Owners 1-2	Owner 3	Owner 4
<b>Damage Brands</b> Salvage   Junk   Rebuilt   Fire   Flood   Hail   Lemon	<input checked="" type="checkbox"/> <b>Guaranteed</b> No Problem	<input checked="" type="checkbox"/> <b>Guaranteed</b> No Problem	<input checked="" type="checkbox"/> <b>Guaranteed</b> No Problem
<b>Odometer Brands</b> Not Actual Mileage   Exceeds Mechanical Limits	<input checked="" type="checkbox"/> <b>Guaranteed</b> No Problem	<input checked="" type="checkbox"/> <b>Guaranteed</b> No Problem	<input checked="" type="checkbox"/> <b>Guaranteed</b> No Problem

 **GUARANTEED** - None of these title problems were reported by a U.S. state Department of Motor Vehicles (DMV). If you find that any of these title problems were reported by a DMV and not included in this report, you may qualify.  
View Terms | View Certificate

 <b>Ownership History</b> The number of owners is estimated	Owners 1-2	Owner 3	Owner 4
Year purchased	2010	2015	2023
Type of owner	Personal	Personal	Personal
Estimated length of ownership	4 yrs. 11 mo.	7 yrs. 10 mo.	8 months
Owned in the following states/provinces	Michigan, Michigan	Michigan	Michigan
Estimated miles driven per year	See Details	8,595/yr	---
Last reported odometer reading	80,201	140,212	---

 <b>Detailed History</b>			
 <b>Owner 1</b> Purchased: 2010	Personal Vehicle 20,307 mi/yr		
Date	Mileage	Source	Comments

05/03/2010	8	Williams Kia Traverse City, MI 231-946-1111 williamstc.com ★ 4.6 / 5.0 103 Verified Reviews ♥ 55 Customer Favorites		<b>Vehicle serviced</b> Pre-delivery inspection completed
05/18/2010	9	Williams Kia Traverse City, MI 231-946-1111 williamstc.com ★ 4.6 / 5.0 103 Verified Reviews ♥ 55 Customer Favorites		<b>Vehicle serviced</b>
08/10/2010	11	Michigan Motor Vehicle Dept. Lake City, MI Title #603Y2220959		<b>Title or registration issued</b> First owner reported Titled or registered as personal vehicle
10/08/2010	3,478	Williams Kia Traverse City, MI 231-946-1111 williamstc.com ★ 4.6 / 5.0 103 Verified Reviews ♥ 55 Customer Favorites		<b>Vehicle serviced</b> Fluids checked Oil and filter changed Electrical system checked
02/15/2011	10,447	Williams Kia Traverse City, MI 231-946-1111 williamstc.com ★ 4.6 / 5.0 103 Verified Reviews ♥ 55 Customer Favorites		<b>Vehicle serviced</b> Fluids checked Oil and filter changed Engine checked
04/08/2011		Michigan Motor Vehicle Dept. Lake City, MI		<b>Registration issued or renewed</b>
06/17/2011	17,280	Williams Kia Traverse City, MI 231-946-1111 williamstc.com ★ 4.6 / 5.0 103 Verified Reviews ♥ 55 Customer Favorites		<b>Vehicle serviced</b> Maintenance inspection completed Tires rotated Fluids checked Oil and filter changed

12/06/2011	27,829	Williams Kia Traverse City, MI 231-946-1111 williamstc.com ★ 4.6 / 5.0 103 Verified Reviews ❤️ 55 Customer Favorites		<b>Vehicle serviced</b> Maintenance inspection completed Fluids checked Oil and filter changed
04/11/2012		Michigan Motor Vehicle Dept. Lake City, MI		<b>Registration issued or renewed</b>
06/14/2012	37,768	Williams Kia Traverse City, MI 231-946-1111 williamskia.com/ ★ 4.6 / 5.0 103 Verified Reviews ❤️ 55 Customer Favorites		<b>Vehicle serviced</b> Maintenance inspection completed Air filter replaced Automatic transmission serviced Oil and filter changed Transmission serviced Fluids checked Fuel system checked Cooling system checked Antifreeze/coolant flushed/changed Cabin air filter replaced/cleaned
10/26/2012	45,672	Williams Kia Traverse City, MI 231-946-1111 williamskia.com/ ★ 4.6 / 5.0 103 Verified Reviews ❤️ 55 Customer Favorites		<b>Vehicle serviced</b> Maintenance inspection completed Oil and filter changed Fluids checked Electrical system checked
03/29/2013	54,408	Williams Kia Traverse City, MI 231-946-1111 williamskia.com/ ★ 4.6 / 5.0 103 Verified Reviews ❤️ 55 Customer Favorites		<b>Vehicle serviced</b> Maintenance inspection completed Oil and filter changed Fluids checked
04/05/2013		Michigan Motor Vehicle Dept. Lake City, MI		<b>Registration issued or renewed</b>
06/04/2013	57,580	Williams Kia Traverse City, MI 231-946-1111 williamskia.com/ ★ 4.6 / 5.0 103 Verified Reviews ❤️ 55 Customer Favorites		<b>Vehicle serviced</b> Oil and filter changed

06/10/2013 57,584 Williams Chevrolet  
 Honda  
 Traverse City, MI  
 231-668-9150  
 williamschevy.com/  
 ★ 4.7 / 5.0  
 849 Verified Reviews  
 ❤️ 7,346 Customer Favorites

 **Vehicle serviced**

08/23/2013 Auto Auction **Vehicle sold**



Millions of used vehicles are bought and sold at auction every year.



08/26/2013 Williams Kia  
 Traverse City, MI  
 231-946-1111  
 williamstc.com  
 ★ 4.6 / 5.0  
 103 Verified Reviews  
 ❤️ 55 Customer Favorites

**Vehicle sold**

08/27/2013 Dealer Inventory **Vehicle offered for sale**

09/06/2013 Williams Chevrolet  
 Honda  
 Traverse City, MI  
 231-668-9150  
 williamstc.com  
 ★ 4.7 / 5.0  
 849 Verified Reviews  
 ❤️ 7,346 Customer Favorites





**Vehicle sold**

 **Owner 2**  
 Purchased: 2013 

**Low mileage!** This owner drove less than the industry average of 15,000 miles per year.

Personal Vehicle  
 11,588 mi/yr

Date	Mileage	Source	Comments
09/06/2013		Michigan Motor Vehicle Dept. Interlochen, MI Title #603B2491821	<b>Title or registration issued</b> New owner reported

09/09/2013	58,109	Williams Chevrolet Honda Traverse City, MI 231-668-9150 williamschevy.com/ ★ <b>4.7 / 5.0</b> 849 Verified Reviews ♥ <b>7,346</b> Customer Favorites		<b>Vehicle serviced</b> Two wheel alignment performed Tire(s) balanced Tires rotated Mirror(s) checked Four tires balanced Four tires mounted Tire(s) mounted Four tires replaced Tire condition and pressure checked
12/03/2013	60,766	Williams Kia Traverse City, MI 231-946-1111 williamskia.com/ ★ <b>4.6 / 5.0</b> 103 Verified Reviews ♥ <b>55</b> Customer Favorites		<b>Vehicle serviced</b> Maintenance inspection completed Oil and filter changed Wiper(s) replaced Fluids checked Brake light switch replaced
01/30/2014		Michigan Motor Vehicle Dept. Interlochen, MI		<b>Registration issued or renewed</b>
05/06/2014	65,256	Williams Chevrolet Honda Traverse City, MI 231-668-9150 williamschevy.com/ ★ <b>4.7 / 5.0</b> 849 Verified Reviews ♥ <b>7,346</b> Customer Favorites		<b>Vehicle serviced</b> Oil and filter changed Engine oil/fluid leak checked
08/20/2014	68,603	Williams Fast Lube Traverse City, MI 231-995-7546 ★ <b>4.2 / 5.0</b> 160 Verified Reviews ♥ <b>97</b> Customer Favorites		<b>Vehicle serviced</b> Oil and filter changed
09/25/2014	69,570	Williams Kia Traverse City, MI 231-946-1111 williamskia.com/ ★ <b>4.6 / 5.0</b> 103 Verified Reviews ♥ <b>55</b> Customer Favorites		<b>Vehicle serviced</b> Maintenance inspection completed Tires rotated

11/28/2014 71,821	Williams Chevrolet Honda Traverse City, MI 231-668-9150 williamschevy.com/		<b>Vehicle serviced</b> Four wheel alignment performed Alignment performed Tire(s) balanced Tires rotated Wiper(s) replaced Oil and filter changed
01/30/2015	Michigan Motor Vehicle Dept. Interlochen, MI		<b>Registration issued or renewed</b>
05/27/2015 77,369	Williams Kia Traverse City, MI 231-946-1111 williamskia.com/		<b>Vehicle serviced</b> Maintenance inspection completed Oil and filter changed Fluids checked Electrical system checked
08/05/2015 80,174	Williams Kia Traverse City, MI 231-946-1111 williamstc.com		<b>Vehicle offered for sale</b>
08/07/2015 80,175	Williams Kia Traverse City, MI 231-946-1111 williamskia.com/		<b>Vehicle serviced</b> Pre-delivery inspection completed Maintenance inspection completed Oil and filter changed Transmission serviced Fluids checked Automatic transmission serviced Cabin air filter replaced/cleaned

★ 4.7 / 5.0

849 Verified Reviews  
 7,346 Customer Favorites

★ 4.6 / 5.0

103 Verified Reviews  
 55 Customer Favorites

★ 4.6 / 5.0

103 Verified Reviews  
 55 Customer Favorites

★ 4.6 / 5.0

103 Verified Reviews  
 55 Customer Favorites



Looks like this dealer serviced the car in order to prepare it for sale. That's a good thing!





08/10/2015		Williams Chevrolet Honda Traverse City, MI 231-668-9150 williamschevy.com/ ★ 4.7 / 5.0 849 Verified Reviews ❤️ 7,346 Customer Favorites	 <b>Vehicle serviced</b> Vehicle washed/detailed
------------	--	--	--

09/29/2015	80,201	Williams Kia Traverse City, MI 231-946-1111 williamstc.com ★ 4.6 / 5.0 103 Verified Reviews ❤️ 55 Customer Favorites	<b>Vehicle sold</b>
------------	--------	--	---------------------





10/01/2015		Michigan Motor Vehicle Dept. Houghton Lake, MI	<b>Registration issued or renewed</b>
------------	--	--	---------------------------------------

10/02/2015		Michigan Motor Vehicle Dept. Houghton Lake, MI	<b>Loan or lien reported</b>
------------	--	--	------------------------------

 <b>Owner 3</b> Purchased: 2015		<b>Low mileage!</b> This owner drove less than the industry average of 15,000 miles per year.	Personal Vehicle 8,595 mi/yr
---	---	---	---------------------------------

Date	Mileage	Source	Comments
10/02/2015		Michigan Motor Vehicle Dept. Houghton Lake, MI Title #603D2742299	<b>Title issued or updated</b> New owner reported

03/11/2016	84,681	Walmart Auto Care Center Houghton Lake, MI 989-366-8997 https://www.walmart.com ★ 4.8 / 5.0 29 Verified Reviews	 <b>Vehicle serviced</b> Oil and filter changed
------------	--------	--	---

05/29/2016	87,900	Walmart Auto Care Center Houghton Lake, MI 989-366-8997 https:// www.walmart.com ★ <b>4.8 / 5.0</b> 29 Verified Reviews		<b>Vehicle serviced</b> Oil and filter changed
08/19/2016	90,774	Williams Kia Traverse City, MI 231-946-1111 williamskia.com/ ★ <b>4.6 / 5.0</b> 103 Verified Reviews ♥ <b>55</b> Customer Favorites		<b>Vehicle serviced</b> Maintenance inspection completed Tires rotated Brakes checked Oil and filter changed
09/01/2016		Michigan Motor Vehicle Dept. Houghton Lake, MI		<b>Registration issued or renewed</b>
11/03/2016	96,313	Medved Kia Wheat Ridge, CO 303-242-5634 medvedkia.com ★ <b>4.7 / 5.0</b> 42 Verified Reviews		<b>Vehicle serviced</b> Front brake rotor(s) resurfaced Front brake pads replaced
05/17/2017		Damage Report		<b>Damage reported: minor damage</b> Damage to left rear Damage to rear



**CARFAX HAS THE MOST ACCIDENT & DAMAGE INFORMATION**

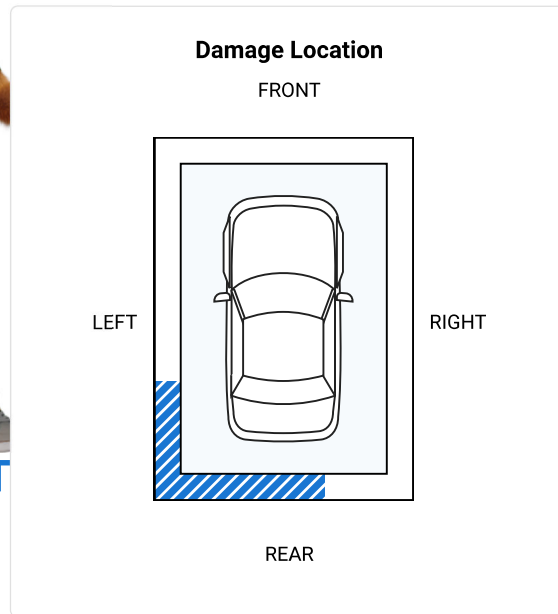
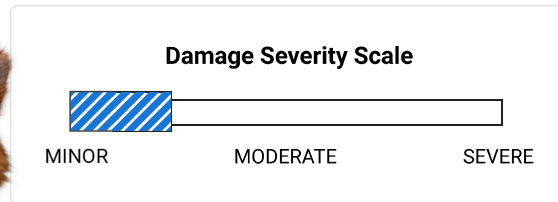

Minor damage is usually cosmetic, including dents or scratches to the vehicle body.

06/04/2017

Damage Report



**Accident reported: minor damage**

Damage to right rear

Damage to rear





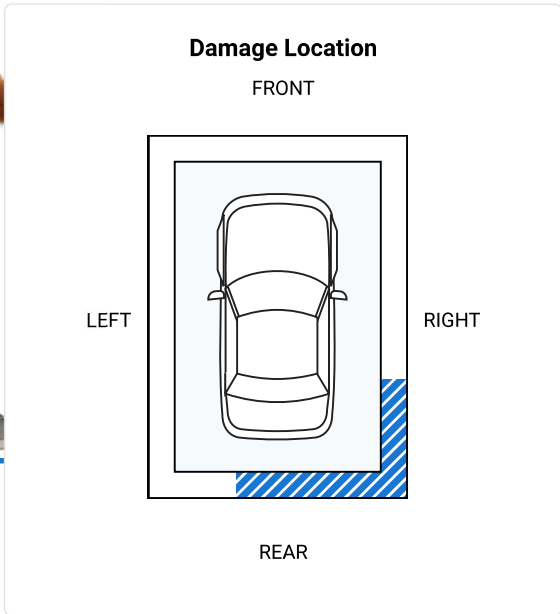
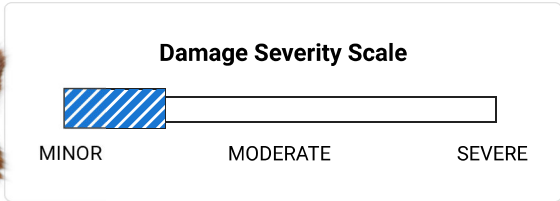













**CARFAX HAS THE MOST ACCIDENT & DAMAGE INFORMATION**



Minor damage is usually cosmetic, including dents or scratches to the vehicle body.

06/20/2017		Michigan Motor Vehicle Dept. Houghton Lake, MI		<b>Registration issued or renewed</b>
08/15/2018		Michigan Motor Vehicle Dept. Houghton Lake, MI		<b>Registration issued or renewed</b>
03/13/2019	115,776	Muffler Man Houghton Lake, MI 989-366-0000 ❤️ 6 Customer Favorites		<b>Vehicle serviced</b> Oil and filter changed
08/30/2019		Michigan Motor Vehicle Dept. Houghton Lake, MI		<b>Registration issued or renewed</b>
10/11/2019	120,380	Muffler Man Houghton Lake, MI 989-366-0000 ❤️ 6 Customer Favorites		<b>Vehicle serviced</b> Oil and filter changed

12/07/2019	121,352	Muffler Man Houghton Lake, MI 989-366-0000  6 Customer Favorites		<b>Vehicle serviced</b> Rear brake pads replaced
08/11/2020		Michigan Motor Vehicle Dept. Houghton Lake, MI		<b>Registration issued or renewed</b>
05/26/2021	125,997	Muffler Man Houghton Lake, MI 989-366-0000  6 Customer Favorites		<b>Vehicle serviced</b> Oil and filter changed Front brake pads replaced Front brake rotor(s) replaced A/C refrigerant recharged
06/16/2021		Michigan Motor Vehicle Dept. Houghton Lake, MI		<b>Registration issued or renewed</b>
08/17/2021	127,568	Muffler Man Houghton Lake, MI 989-366-0000  6 Customer Favorites		<b>Vehicle serviced</b> Oil and filter changed
09/10/2021	129,055	Muffler Man Houghton Lake, MI 989-366-0000  6 Customer Favorites		<b>Vehicle serviced</b> Oil and filter changed
11/15/2021		WILSONS AUTOMOTIVE Houghton Lake, MI 989-202-4411 wilsonsautomotivemi.net/  4.9 / 5.0 7 Verified Reviews  26 Customer Favorites		<b>Vehicle serviced</b>
11/23/2021	131,803	Muffler Man Houghton Lake, MI 989-366-0000  6 Customer Favorites		<b>Vehicle serviced</b> Rear shock absorber(s) replaced Outer tie rod(s) replaced Sway bar link(s) replaced
01/19/2022	133,879	Muffler Man Houghton Lake, MI 989-366-0000  6 Customer Favorites		<b>Vehicle serviced</b> Oil and filter changed
08/01/2022		Michigan Motor Vehicle Dept. Houghton Lake, MI		<b>Registration issued or renewed</b>

08/25/2022	140,212	Walmart Auto Care Center Houghton Lake, MI 989-366-8997 https://www.walmart.com ★ 4.8 / 5.0 29 Verified Reviews	 <b>Vehicle serviced</b> Oil and filter changed
01/11/2023		Michigan Motor Vehicle Dept. Houghton Lake, MI Title #MI0015932948	<b>Title issued or updated</b> Duplicate title issued

 **Owner 4** Personal Vehicle  
Purchased: 2023

Date	Mileage	Source	Comments
08/30/2023		Michigan Motor Vehicle Dept. Houghton Lake, MI Title #MI0018444488	<b>Vehicle purchase reported</b> Title issued or updated Registration issued or renewed New owner reported Exempt from odometer reporting
11/15/2023		Michigan Motor Vehicle Dept. Houghton Lake, MI	<b>Registration issued or renewed</b>

Have Questions? Consumers, please visit our Help Center at [www.carfax.com](http://www.carfax.com). Dealers or Subscribers, please visit our Help Center at [www.carfaxonline.com](http://www.carfaxonline.com).



**Glossary**

**Accident Indicator**

CARFAX receives information about accidents in all 50 states, the District of Columbia and Canada.

Not every accident is reported to CARFAX. As details about the accident become available, those additional details are added to the CARFAX Vehicle History Report. CARFAX recommends that you have this vehicle inspected by a qualified mechanic.

- According to the National Safety Council, Injury Facts, 2021 edition, 5% of the 276 million registered vehicles in the U.S. were involved in an accident in 2019. Over 77% of these were considered minor or moderate.
- This CARFAX Vehicle History Report is based only on information supplied to CARFAX and available as of 5/11/24 at 6:23:12 AM (CDT). Other information about this vehicle, including problems, may not have been reported to CARFAX. Use this report as one important tool, along with a vehicle inspection and test drive, to make a better decision about your next used car.

**Damage Indicator**

Damage can be a result of many different types of events. Examples include contact with objects (other cars, trees, traffic signs, road debris, etc), vandalism, or weather-related events. Not every damage event is reported to

CARFAX. As details about the damage event become available, those additional details are added to the CARFAX Vehicle History Report. CARFAX recommends that you have this vehicle inspected by a qualified mechanic.

- This CARFAX Vehicle History Report is based only on information supplied to CARFAX and available as of 5/11/24 at 6:23:12 AM (CDT). Other information about this vehicle, including problems, may not have been reported to CARFAX. Use this report as one important tool, along with a vehicle inspection and test drive, to make a better decision about your next used car.

### Damage Severity

Damage events result in one of the following severity levels:

- **Minor:** Generally, minor damage is cosmetic (including dents or scratches), may only require reconditioning, and typically does not compromise a vehicle's operation and/or safety.
- **Moderate:** Moderate damage may affect multiple components of the vehicle and may impair the vehicle's operation and/or safety.
- **Severe:** Severe damage usually affects multiple components of the vehicle and is likely to compromise the vehicle's operation and/or safety.

CARFAX recommends getting a pre-purchase inspection at a certified collision repair facility.

### First Owner

When the first owner(s) obtains a title from a Department of Motor Vehicles as proof of ownership.

### New Owner Reported

When a vehicle is sold to a new owner, the Title must be transferred to the new owner(s) at a Department of Motor Vehicles.

### Ownership History

CARFAX defines an owner as an individual or business that possesses and uses a vehicle. Not all title transactions represent changes in ownership. To provide estimated number of owners, CARFAX proprietary technology analyzes all the events in a vehicle history. Estimated ownership is available for vehicles manufactured after 1991 and titled solely in the US including Puerto Rico. Dealers sometimes opt to take ownership of a vehicle and are required to in the following states: Maine, Massachusetts, New Jersey, Ohio, Oklahoma, Pennsylvania and South Dakota. Please consider this as you review a vehicle's estimated ownership history.

### Title Issued

A state issues a title to provide a vehicle owner with proof of ownership. Each title has a unique number. Each title or registration record on a CARFAX report does not necessarily indicate a change in ownership. In Canada, a registration and bill of sale are used as proof of ownership.

Follow Us:



[facebook.com/CARFAX](https://www.facebook.com/CARFAX)



[@CARFAXinc](https://twitter.com/CARFAXinc)



About CARFAX

CARFAX DEPENDS ON ITS SOURCES FOR THE ACCURACY AND RELIABILITY OF ITS INFORMATION. THEREFORE, NO RESPONSIBILITY IS ASSUMED BY CARFAX OR ITS AGENTS FOR ERRORS OR OMISSIONS IN THIS REPORT. CARFAX FURTHER EXPRESSLY DISCLAIMS ALL WARRANTIES, EXPRESS OR IMPLIED, INCLUDING ANY IMPLIED WARRANTIES OF MERCHANTABILITY OR FITNESS FOR A PARTICULAR PURPOSE.

© 2024 CARFAX, Inc., part of S&P Global. All rights reserved.  
5/11/24 6:23:12 AM (CDT)

**I have reviewed and received a copy of the CARFAX Vehicle History Report for this 2010 KIA OPTIMA vehicle (VIN: KNAGG4A85A5434700), which is based on information supplied to CARFAX and available as of 5/11/24 at 7:23 AM (EDT).**

Customer Signature

Date

Dealer Signature

Date