



### History-Based Value Report

#### History events affecting this vehicle's value



Service History



Personal Vehicle



Accident Reported

**\$3,040 Retail Value**



### Vehicle History Report™

US \$44.99

#### 2005 VOLVO V70 2.4

VIN: YV1SW612952518057  
WAGON 4 DR  
2.4L I5 F DOHC 20V  
GASOLINE  
FRONT WHEEL DRIVE



Accident reported: moderate damage

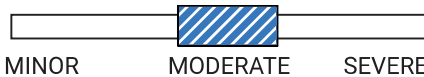

51 Service history records



3 Previous owners



Personal vehicle



188,080 Last reported odometer reading



This CARFAX Vehicle History Report is based only on information supplied to CARFAX and available as of 7/27/24 at 7:06:00 AM (CDT). Other information about this vehicle, including problems, may not have been reported to CARFAX. Use this report as one important tool, along with a vehicle inspection and test drive, to make a better decision about your next used car.



### Accident / Damage History

Not all accidents / issues are reported to CARFAX

#### Event 1

03/07/2005

**Accident reported:  
moderate damage  
with another motor  
vehicle**

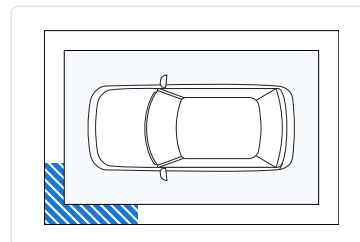
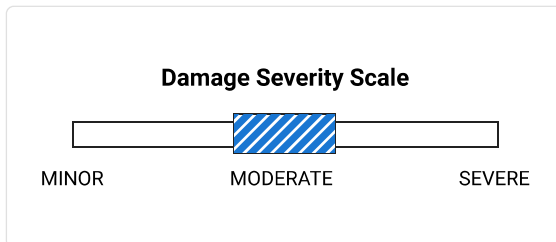

#### Event 2

07/27/2011

**Accident reported**

#### Event 3

09/30/2011

**Accident reported:  
very minor damage**

Vehicle involved in a  
rear-end collision  
Airbags did not deploy

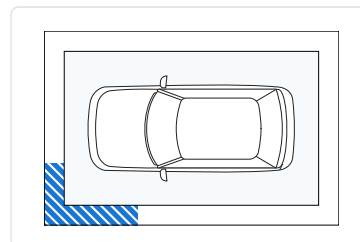
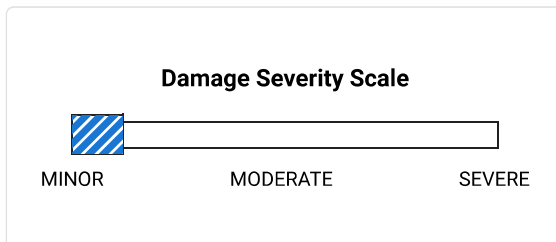



#### Event 4

04/27/2018

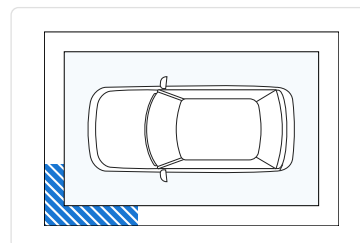
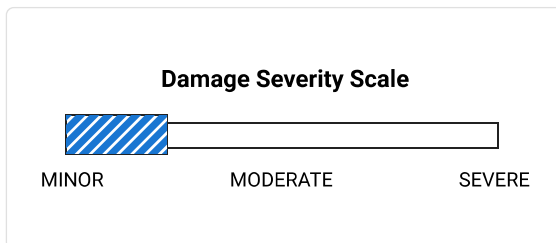
**Damage reported:  
minor damage**



 <b>Additional History</b> Not all accidents / issues are reported to CARFAX	Owner 1	Owner 2	Owner 3
<b>Total Loss</b> No total loss reported to CARFAX.	<input checked="" type="checkbox"/> No Issues Reported	<input checked="" type="checkbox"/> No Issues Reported	<input checked="" type="checkbox"/> No Issues Reported
<b>Structural Damage</b> CARFAX recommends that you have this vehicle inspected by a collision repair specialist.	<input checked="" type="checkbox"/> No Issues Reported	<input checked="" type="checkbox"/> No Issues Reported	<input checked="" type="checkbox"/> No Issues Reported
<b>Airbag Deployment</b> No airbag deployment reported to CARFAX.	<input checked="" type="checkbox"/> No Issues Reported	<input checked="" type="checkbox"/> No Issues Reported	<input checked="" type="checkbox"/> No Issues Reported
<b>Odometer Check</b> No indication of an odometer rollback.	<input checked="" type="checkbox"/> No Issues Indicated	<input checked="" type="checkbox"/> No Issues Indicated	<input checked="" type="checkbox"/> No Issues Indicated
<b>Accident / Damage</b> Accidents reported: 03/07/2005, 07/27/2011, and 09/30/2011. Damage reported: 04/27/2018.	Accident Reported	Damage Reported	No New Issues Reported
<b>Manufacturer Recall</b> Check with an authorized Volvo dealer for any open recalls.	<input checked="" type="checkbox"/> No Recalls Reported	<input checked="" type="checkbox"/> No Recalls Reported	<input checked="" type="checkbox"/> No Recalls Reported
<b>Basic Warranty</b> Original warranty estimated to have expired.	Warranty Expired	Warranty Expired	Warranty Expired

 <b>Title History</b> CARFAX guarantees the information in this section	Owner 1	Owner 2	Owner 3
<b>Damage Brands</b> Salvage   Junk   Rebuilt   Fire   Flood   Hail   Lemon	<input checked="" type="checkbox"/> <b>Guaranteed</b> No Problem	<input checked="" type="checkbox"/> <b>Guaranteed</b> No Problem	<input checked="" type="checkbox"/> <b>Guaranteed</b> No Problem
<b>Odometer Brands</b> Not Actual Mileage   Exceeds Mechanical Limits	<input checked="" type="checkbox"/> <b>Guaranteed</b> No Problem	<input checked="" type="checkbox"/> <b>Guaranteed</b> No Problem	<input checked="" type="checkbox"/> <b>Guaranteed</b> No Problem



**GUARANTEED** - None of these title problems were reported by a U.S. state Department of Motor Vehicles (DMV). If you find that any of these title problems were reported by a DMV and not included in this report, you may qualify. [View Terms](#) | [View Certificate](#)

 <b>Ownership History</b> The number of owners is estimated	Owner 1	Owner 2	Owner 3
Year purchased	2005	2013	2024
Type of owner	Personal	Personal	Personal

Estimated length of ownership	7 yrs. 9 mo.	10 yrs. 10 mo.	3 months
Owned in the following states/provinces	North Carolina	North Carolina	Michigan
Estimated miles driven per year	16,736/yr	5,378/yr	---
Last reported odometer reading	132,365	188,080	---

**CARFAX** Detailed History

 **Owner 1**  
Purchased: 2005

Personal Vehicle  
16,736 mi/yr

Date	Mileage	Source	Comments
Not Reported		Volvo Cars of North America, LLC	<b>Vehicle manufactured</b> Barents blue pearl exterior Arena leather interior

03/07/2005      Damage Report









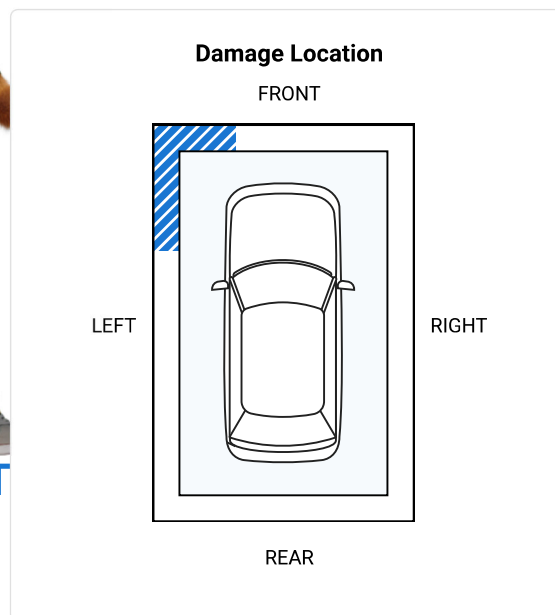
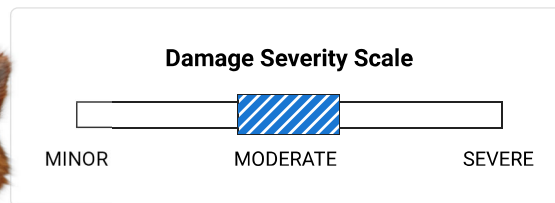



**Accident reported: moderate damage with another motor vehicle**  
Damage to left front













**CARFAX HAS THE MOST ACCIDENT & DAMAGE INFORMATION**









05/13/2005		US Customs		<b>Vehicle exported from</b> Belgium and imported to Brunswick, GA
05/25/2005	4	Volvo of Charlotte Charlotte, NC 704-563-1000 volvocharlotte.com ★ 4.4 / 5.0 60 Verified Reviews		<b>Vehicle serviced</b> Pre-delivery inspection completed Exterior trim checked Safety inspection performed
06/23/2005		Volvo Saab of Charlotte Charlotte, NC 704-563-1000 charlottevolvo.com		<b>Vehicle sold</b>
06/23/2005	85	Service Plan Co. Charlotte, NC		<b>Service contract issued</b>
06/23/2005		North Carolina Motor Vehicle Dept. Charlotte, NC		<b>First owner reported</b> Titled or registered as personal vehicle
06/30/2005	667	Volvo of Charlotte Charlotte, NC 704-563-1000 volvocharlotte.com ★ 4.4 / 5.0 60 Verified Reviews		<b>Vehicle serviced</b> Interior trim checked Exterior trim checked
09/30/2005	7,735	Volvo of Charlotte Charlotte, NC 704-563-1000 volvocharlotte.com ★ 4.4 / 5.0 60 Verified Reviews		<b>Vehicle serviced</b> Recommended maintenance performed
11/03/2005	10,301	Volvo of Charlotte Charlotte, NC 704-563-1000 volvocharlotte.com ★ 4.4 / 5.0 60 Verified Reviews		<b>Vehicle serviced</b> Noise checked
01/20/2006	14,995	Volvo of Charlotte Charlotte, NC 704-563-1000 volvocharlotte.com ★ 4.4 / 5.0 60 Verified Reviews		<b>Vehicle serviced</b> 15,000 mile service performed





05/23/2006	23,005	Volvo of Charlotte Charlotte, NC 704-563-1000 volvocharlotte.com ★ 4.4 / 5.0 60 Verified Reviews		<b>Vehicle serviced</b> Recommended maintenance performed
05/23/2006		North Carolina Inspection Station Charlotte, NC		<b>Passed emissions inspection</b>
08/18/2006	27,368	Volvo of Charlotte Charlotte, NC 704-563-1000 volvocharlotte.com ★ 4.4 / 5.0 60 Verified Reviews		<b>Vehicle serviced</b> Exterior trim checked
09/08/2006	28,901	Volvo of Charlotte Charlotte, NC 704-563-1000 volvocharlotte.com ★ 4.4 / 5.0 60 Verified Reviews		<b>Vehicle serviced</b> Engine checked Exterior trim checked
09/11/2006		North Carolina Motor Vehicle Dept. Charlotte, NC Title #771969051877118		<b>Registration issued or renewed</b> Passed safety inspection
10/03/2006	30,038	Volvo of Charlotte Charlotte, NC 704-563-1000 volvocharlotte.com ★ 4.4 / 5.0 60 Verified Reviews		<b>Vehicle serviced</b> 30,000 mile service performed Engine checked
10/26/2006	31,759	Volvo of Charlotte Charlotte, NC 704-563-1000 volvocharlotte.com ★ 4.4 / 5.0 60 Verified Reviews		<b>Vehicle serviced</b> Interior trim checked
11/28/2006	33,177	Volvo of Charlotte Charlotte, NC 704-563-1000 volvocharlotte.com ★ 4.4 / 5.0 60 Verified Reviews		<b>Vehicle serviced</b> Interior trim checked

02/22/2007	37,708	Volvo of Charlotte Charlotte, NC 704-563-1000 volvocharlotte.com ★ 4.4 / 5.0 60 Verified Reviews		<b>Vehicle serviced</b> Recommended maintenance performed
04/11/2007	40,234	Volvo of Charlotte Charlotte, NC 704-563-1000 volvocharlotte.com ★ 4.4 / 5.0 60 Verified Reviews		<b>Vehicle serviced</b>
05/23/2007	42,275	Volvo of Charlotte Charlotte, NC 704-563-1000 volvocharlotte.com ★ 4.4 / 5.0 60 Verified Reviews		<b>Vehicle serviced</b> Electrical system checked Oil and filter changed Wiper(s) replaced Rear wiper blade replaced Emissions inspection performed
05/30/2007	42,823	North Carolina Inspection Station Charlotte, NC		<b>Passed emissions inspection</b>
08/30/2007		North Carolina Motor Vehicle Dept. Charlotte, NC Title #771969051877118		<b>Registration issued or renewed</b> Passed safety inspection
09/19/2007	48,025	Volvo of Charlotte Charlotte, NC 704-563-1000 volvocharlotte.com ★ 4.4 / 5.0 60 Verified Reviews		<b>Vehicle serviced</b> 45,000 mile service performed
12/05/2007	51,505	Volvo of Charlotte Charlotte, NC 704-563-1000 volvocharlotte.com ★ 4.4 / 5.0 60 Verified Reviews		<b>Vehicle serviced</b> Wheels checked Tire(s) balanced One wheel replaced
02/01/2008	53,784	Volvo of Charlotte Charlotte, NC 704-563-1000 volvocharlotte.com ★ 4.4 / 5.0 60 Verified Reviews		<b>Vehicle serviced</b> Recommended maintenance performed



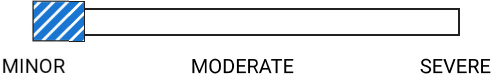
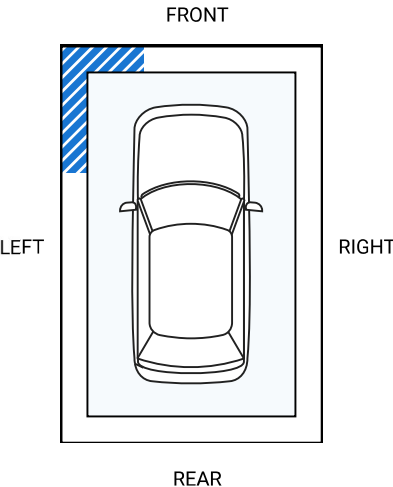

05/20/2008	59,414	Volvo of Charlotte Charlotte, NC 704-563-1000 volvocharlotte.com ★ 4.4 / 5.0 60 Verified Reviews		<b>Vehicle serviced</b> 60,000 mile service performed Drive belts checked Serpentine belt replaced Emissions inspection performed
05/20/2008		North Carolina Inspection Station Charlotte, NC		<b>Passed emissions inspection</b>
09/03/2008		North Carolina Motor Vehicle Dept. Charlotte, NC Title #771969051877118		<b>Registration issued or renewed</b> Passed safety inspection
10/07/2008	64,412	Volvo of Charlotte Charlotte, NC 704-563-1000 volvocharlotte.com ★ 4.4 / 5.0 60 Verified Reviews		<b>Vehicle serviced</b> Recommended maintenance performed
01/30/2009	69,278	Volvo of Charlotte Charlotte, NC 704-563-1000 volvocharlotte.com ★ 4.4 / 5.0 60 Verified Reviews		<b>Vehicle serviced</b> 70,000 mile service performed Rear brake pads replaced
06/03/2009	74,754	Volvo of Charlotte Charlotte, NC 704-563-1000 volvocharlotte.com ★ 4.4 / 5.0 60 Verified Reviews		<b>Vehicle serviced</b> 75,000 mile service performed Engine checked Emissions inspection performed
06/13/2009	75,081	North Carolina Inspection Station Charlotte, NC		<b>Passed emissions inspection</b>
09/01/2009		North Carolina Motor Vehicle Dept. Charlotte, NC Title #771969051877118		<b>Registration issued or renewed</b> Passed safety inspection





















10/27/2009	82,262	Volvo of Charlotte Charlotte, NC 704-563-1000 volvocharlotte.com ★ 4.4 / 5.0 60 Verified Reviews		<b>Vehicle serviced</b> Recommended maintenance performed Brakes checked Wheels checked Four wheel alignment performed Front brake rotor(s) replaced Front brake pads replaced Alignment performed
04/30/2010		Service Facility Charlotte, NC		<b>Vehicle serviced</b> Windshield repaired
05/12/2010	89,368	Volvo of Charlotte Charlotte, NC 704-563-1000 volvocharlotte.com ★ 4.4 / 5.0 60 Verified Reviews		<b>Vehicle serviced</b> 90,000 mile service performed
09/10/2010	94,580	North Carolina Inspection Station Charlotte, NC		<b>Passed emissions inspection</b>
09/23/2010		North Carolina Motor Vehicle Dept. Charlotte, NC Title #771969051877118		<b>Registration issued or renewed</b> Passed safety inspection
11/02/2010	97,264	Volvo of Charlotte Charlotte, NC 704-563-1000 volvocharlotte.com ★ 4.4 / 5.0 60 Verified Reviews		<b>Vehicle serviced</b> Recommended maintenance performed
04/12/2011		Volvo of Charlotte Charlotte, NC 704-563-1000 volvocharlotte.com ★ 4.4 / 5.0 60 Verified Reviews		<b>Vehicle serviced</b> Recommended maintenance performed Exterior trim checked
07/27/2011		Damage Report		<b>Accident reported</b>
08/17/2011	110,209	North Carolina Inspection Station Charlotte, NC		<b>Passed emissions inspection</b>





08/22/2011	North Carolina Motor Vehicle Dept. Charlotte, NC Title #771969051877118	<b>Registration issued or renewed</b>
09/26/2011	Volvo of Charlotte Charlotte, NC 704-563-1000 volvocharlotte.com ★ <b>4.4 / 5.0</b> 60 Verified Reviews	 <b>Vehicle serviced</b> Recommended maintenance performed Wheels checked
09/30/2011	Damage Report	 <b>Accident reported: very minor damage</b> Vehicle involved in a rear-end collision Damage to left front Airbags did not deploy
		<div data-bbox="857 835 1409 1035"> <p><b>Damage Severity Scale</b></p>  <p>MINOR                      MODERATE                      SEVERE</p> </div> <div data-bbox="857 1045 1409 1654"> <p><b>Damage Location</b></p>  <p>FRONT</p> <p>LEFT                      RIGHT</p> <p>REAR</p> </div>
02/09/2012 116,369	Volvo of Charlotte Charlotte, NC 704-563-1000 volvocharlotte.com ★ <b>4.4 / 5.0</b> 60 Verified Reviews	 <b>Vehicle serviced</b> Wiper(s) replaced Electrical system checked

**CARFAX HAS THE MOST ACCIDENT & DAMAGE INFORMATION**

04/09/2012	119,213	Volvo of Charlotte Charlotte, NC 704-563-1000 volvocharlotte.com ★ 4.4 / 5.0 60 Verified Reviews		<b>Vehicle serviced</b> Recommended maintenance performed Battery/charging system checked Spark plug(s) replaced Air filter replaced Brakes checked Fluids checked Oil and filter changed Brake fluid flushed/changed Maintenance reminder reset Antifreeze/coolant flushed/changed Cabin air filter replaced/cleaned
05/18/2012	121,028	Volvo of Charlotte Charlotte, NC 704-563-1000 volvocharlotte.com ★ 4.4 / 5.0 60 Verified Reviews		<b>Vehicle serviced</b>
08/27/2012	124,794	North Carolina Inspection Station Charlotte, NC		<b>Passed emissions inspection</b>
08/27/2012		North Carolina Motor Vehicle Dept. Charlotte, NC Title #771969051877118		<b>Registration issued or renewed</b>
12/21/2012	128,523	Volvo of Charlotte Charlotte, NC 704-563-1000 volvocharlotte.com ★ 4.4 / 5.0 60 Verified Reviews		<b>Vehicle serviced</b> Recommended maintenance performed
03/07/2013	130,329	Volvo of Charlotte Charlotte, NC 704-563-1000 volvocharlotte.com ★ 4.4 / 5.0 60 Verified Reviews		<b>Vehicle serviced</b> Thermostat replaced Battery replaced Throttle body cleaned/serviced Cooling system checked Electrical system checked
04/18/2013		Dealer Inventory		<b>Vehicle offered for sale</b>

04/19/2013 131,002	University Volvo Charlotte, NC 704-547-1095 universityvolvo.com	<b>Vehicle offered for sale</b>	
	 <b>4.6 / 5.0</b> 99 Verified Reviews  <b>60</b> Customer Favorites		
04/26/2013 131,005	University Volvo Charlotte, NC 704-547-1095 universityvolvo.com	 <b>Vehicle serviced</b> Four wheel alignment performed Oil and filter changed Tire condition and pressure checked Four tires balanced Four tires mounted Safety inspection performed Brake fluid flushed/changed Hood shocks replaced Fuel filler door replaced/repared Fuel filler door adjusted Anti-theft/keyless remote battery replaced CV boot(s) replaced Emissions inspection performed	
	 <b>4.6 / 5.0</b> 99 Verified Reviews  <b>60</b> Customer Favorites		
		Looks like this dealer serviced the car in order to prepare it for sale. That's a good thing!	
05/08/2013 132,365	University Volvo Charlotte, NC 704-547-1095 universityvolvo.com	 <b>Vehicle serviced</b> A/C refrigerant recharged	
	 <b>4.6 / 5.0</b> 99 Verified Reviews  <b>60</b> Customer Favorites		
05/13/2013	University Volvo Charlotte, NC 704-547-1095 universityvolvo.com	<b>Vehicle sold</b>	
	 <b>4.6 / 5.0</b> 99 Verified Reviews  <b>60</b> Customer Favorites		
 <b>Owner 2</b> Purchased: 2013		<b>Low mileage!</b> This owner drove less than the industry average of 15,000 miles per year.	Personal Vehicle 5,378 mi/yr
<b>Date</b>	<b>Mileage Source</b>	<b>Comments</b>	

05/13/2013	132,449	North Carolina Motor Vehicle Dept. Durham, NC Title #77209713133421J		<b>Title or registration issued</b> New owner reported
05/24/2013	135,489	University Volvo Charlotte, NC 704-547-1095 universityvolvo.com ★ <b>4.6 / 5.0</b> 99 Verified Reviews ❤️ <b>60</b> Customer Favorites		<b>Vehicle serviced</b>
10/28/2013	137,229	Mr. Tire Auto Service Centers Durham, NC ★ <b>4.6 / 5.0</b> 25 Verified Reviews ❤️ <b>1</b> Customer Favorite		<b>Vehicle serviced</b> Tire repaired Tire(s) balanced
06/30/2014	144,201	University Volvo Charlotte, NC 704-547-1095 universityvolvo.com ★ <b>4.6 / 5.0</b> 99 Verified Reviews ❤️ <b>60</b> Customer Favorites		<b>Vehicle serviced</b> Oil and filter changed Tire condition and pressure checked Tire(s) balanced Four tires balanced Tires rotated Safety inspection performed Emissions inspection performed
07/22/2014		North Carolina Motor Vehicle Dept. Durham, NC Title #77209713133421J		<b>Registration issued or renewed</b> Registration updated when owner moved the vehicle to a new location
11/07/2014	148,080	Mr. Tire Auto Service Centers Durham, NC ★ <b>4.6 / 5.0</b> 25 Verified Reviews ❤️ <b>1</b> Customer Favorite		<b>Vehicle serviced</b> Tire repaired Tire(s) balanced
07/11/2015	158,164	Mr. Tire Auto Service Centers Durham, NC ★ <b>4.6 / 5.0</b> 25 Verified Reviews ❤️ <b>1</b> Customer Favorite		<b>Vehicle serviced</b> Brakes checked Tires rotated Oil and filter changed Brakes serviced Emissions inspection performed

07/16/2015		North Carolina Motor Vehicle Dept. Durham, NC Title #77209713133421J		<b>Registration issued or renewed</b>
03/22/2016	164,753	Swedish Imports Durham, NC 919-493-4545 ★ 5.0 / 5.0 58 Verified Reviews ❤️ 2 Customer Favorites		<b>Vehicle serviced</b> Fluids checked Transmission fluid changed Blower motor replaced/repaired
06/17/2016	165,886	Swedish Imports Durham, NC 919-493-4545 ★ 5.0 / 5.0 58 Verified Reviews ❤️ 2 Customer Favorites		<b>Vehicle serviced</b> Oil and filter changed CV boot(s) replaced Exterior lights checked Turn signal switch replaced Washer pump replaced Engine/powertrain computer/module checked Fuel filler cap replaced
11/20/2016		North Carolina Motor Vehicle Dept. Durham, NC Title #77209713133421J		<b>Registration issued or renewed</b>
05/10/2017	168,627	Swedish Imports Durham, NC 919-493-4545 ★ 5.0 / 5.0 58 Verified Reviews ❤️ 2 Customer Favorites		<b>Vehicle serviced</b>
06/22/2017	168,974	Swedish Imports Durham, NC 919-493-4545 ★ 5.0 / 5.0 58 Verified Reviews ❤️ 2 Customer Favorites		<b>Vehicle serviced</b> Interior cleaned Emissions inspection performed
07/12/2017		North Carolina Motor Vehicle Dept. Durham, NC Title #77209713133421J		<b>Registration issued or renewed</b>

11/25/2017 170,152 University Volvo  
 Charlotte, NC  
 704-547-1095  
 universityvolvo.com  
 ★ 4.6 / 5.0  
 99 Verified Reviews  
 ❤️ 60 Customer Favorites



**Vehicle serviced**

Four wheel alignment performed  
 Oil and filter changed  
 Tire condition and pressure checked  
 Four tires balanced  
 Four tires mounted  
 Right axle replaced  
 Spark plug(s) replaced

01/31/2018 170,721 Swedish Imports  
 Durham, NC  
 919-493-4545  
 ★ 5.0 / 5.0  
 58 Verified Reviews  
 ❤️ 2 Customer Favorites



**Vehicle serviced**

04/26/2018 171,821 Swedish Imports  
 Durham, NC  
 919-493-4545  
 ★ 5.0 / 5.0  
 58 Verified Reviews  
 ❤️ 2 Customer Favorites



**Vehicle serviced**

04/27/2018 Damage Report







**Damage reported: minor damage**  
 Damage to left front

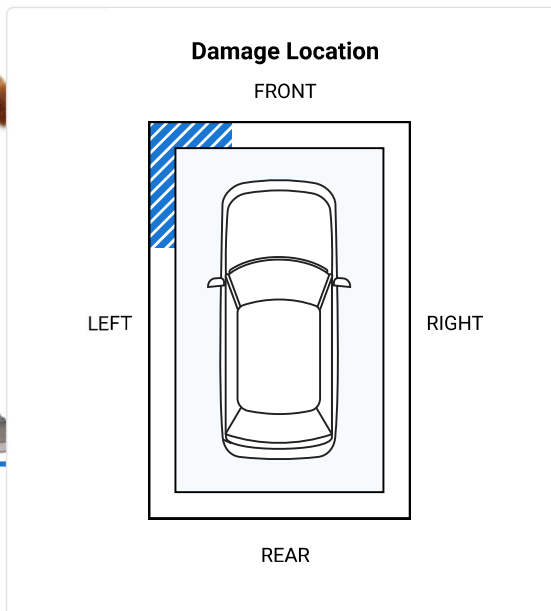
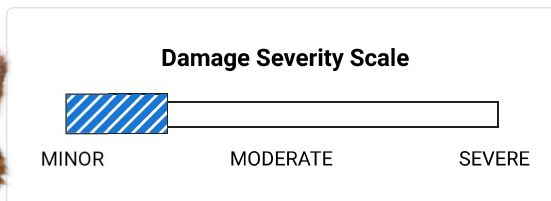

**CARFAX HAS THE MOST ACCIDENT & DAMAGE INFORMATION**



01/18/2019	174,358	Swedish Imports Durham, NC 919-493-4545 ★ <b>5.0 / 5.0</b> 58 Verified Reviews ❤️ <b>2</b> Customer Favorites		<b>Vehicle serviced</b> Engine/powertrain computer/module checked Fuel pressure regulator replaced Emissions inspection performed
02/07/2019		North Carolina Motor Vehicle Dept. Durham, NC Title #77209713133421J		<b>Registration issued or renewed</b>
11/12/2020	178,961	Swedish Imports Durham, NC 919-493-4545 ★ <b>5.0 / 5.0</b> 58 Verified Reviews ❤️ <b>2</b> Customer Favorites		<b>Vehicle serviced</b> Oil and filter changed Rear brake pads replaced Tires rotated Mirror motor replaced Emissions inspection performed
02/03/2022	182,119	Johnson Volvo Cars Durham Durham, NC 877-369-1515 johnsonvolvocarsdurham.com ★ <b>4.8 / 5.0</b> 238 Verified Reviews ❤️ <b>3,541</b> Customer Favorites		<b>Vehicle serviced</b> Engine/powertrain computer/module checked Oil and filter changed Brakes checked Emissions inspection performed
11/28/2022	184,898	Swedish Imports Durham, NC 919-493-4545 swedishimports.net/ ★ <b>5.0 / 5.0</b> 58 Verified Reviews ❤️ <b>2</b> Customer Favorites		<b>Vehicle serviced</b> Radiator replaced Cooling system checked Emissions inspection performed
02/02/2023		North Carolina Motor Vehicle Dept. Durham, NC Title #775935230333012		<b>Title or registration issued</b>



<p>09/13/2023 188,080 Swedish Imports Durham, NC 919-493-4545 swedishimports.net/ ★ 5.0 / 5.0 58 Verified Reviews ❤️ 2 Customer Favorites</p>	 <p><b>Vehicle serviced</b> Liftgate/tailgate support strut(s) replaced Engine/powertrain computer/module checked Tailgate lock/latch repaired</p>
---	---

 **Owner 3** Personal Vehicle  
Purchased: 2024

Date	Mileage	Source	Comments
04/02/2024		Michigan Motor Vehicle Dept.	<b>Vehicle purchase reported</b>
07/17/2024		Michigan Motor Vehicle Dept. Kalamazoo, MI Title #MI0021839032	<b>Title issued or updated</b> New owner reported Exempt from odometer reporting

Have Questions? Consumers, please visit our Help Center at [www.carfax.com](http://www.carfax.com). Dealers or Subscribers, please visit our Help Center at [www.carfaxonline.com](http://www.carfaxonline.com).

**CARFAX** Glossary

**Accident Indicator**

CARFAX receives information about accidents in all 50 states, the District of Columbia and Canada.

Not every accident is reported to CARFAX. As details about the accident become available, those additional details are added to the CARFAX Vehicle History Report. CARFAX recommends that you have this vehicle inspected by a qualified mechanic.

- According to the National Safety Council, Injury Facts, 2021 edition, 5% of the 276 million registered vehicles in the U.S. were involved in an accident in 2019. Over 77% of these were considered minor or moderate.
- This CARFAX Vehicle History Report is based only on information supplied to CARFAX and available as of 7/27/24 at 7:06:00 AM (CDT). Other information about this vehicle, including problems, may not have been reported to CARFAX. Use this report as one important tool, along with a vehicle inspection and test drive, to make a better decision about your next used car.

**Damage Indicator**

Damage can be a result of many different types of events. Examples include contact with objects (other cars, trees, traffic signs, road debris, etc), vandalism, or weather-related events. Not every damage event is reported to CARFAX. As details about the damage event become available, those additional details are added to the CARFAX Vehicle History Report. CARFAX recommends that you have this vehicle inspected by a qualified mechanic.

- This CARFAX Vehicle History Report is based only on information supplied to CARFAX and available as of 7/27/24 at 7:06:00 AM (CDT). Other information about this vehicle, including problems, may not have been reported to CARFAX. Use this report as one important tool, along with a vehicle inspection and test drive, to make a better decision about your next used car.

**Damage Severity**

Damage events result in one of the following severity levels:

- **Minor:** Generally, minor damage is cosmetic (including dents or scratches), may only require reconditioning, and typically does not compromise a vehicle's operation and/or safety.
- **Moderate:** Moderate damage may affect multiple components of the vehicle and may impair the vehicle's operation and/or safety.
- **Severe:** Severe damage usually affects multiple components of the vehicle and is likely to compromise the vehicle's operation and/or safety.

CARFAX recommends getting a pre-purchase inspection at a certified collision repair facility.

#### First Owner

When the first owner(s) obtains a title from a Department of Motor Vehicles as proof of ownership.

#### New Owner Reported

When a vehicle is sold to a new owner, the Title must be transferred to the new owner(s) at a Department of Motor Vehicles.

#### Ownership History

CARFAX defines an owner as an individual or business that possesses and uses a vehicle. Not all title transactions represent changes in ownership. To provide estimated number of owners, CARFAX proprietary technology analyzes all the events in a vehicle history. Estimated ownership is available for vehicles manufactured after 1991 and titled solely in the US including Puerto Rico. Dealers sometimes opt to take ownership of a vehicle and are required to in the following states: Maine, Massachusetts, New Jersey, Ohio, Oklahoma, Pennsylvania and South Dakota. Please consider this as you review a vehicle's estimated ownership history.

#### Title Issued

A state issues a title to provide a vehicle owner with proof of ownership. Each title has a unique number. Each title or registration record on a CARFAX report does not necessarily indicate a change in ownership. In Canada, a registration and bill of sale are used as proof of ownership.

Follow Us:



[facebook.com/CARFAX](https://www.facebook.com/CARFAX)



[@CARFAXinc](https://twitter.com/CARFAXinc)



About CARFAX

CARFAX DEPENDS ON ITS SOURCES FOR THE ACCURACY AND RELIABILITY OF ITS INFORMATION. THEREFORE, NO RESPONSIBILITY IS ASSUMED BY CARFAX OR ITS AGENTS FOR ERRORS OR OMISSIONS IN THIS REPORT. CARFAX FURTHER EXPRESSLY DISCLAIMS ALL WARRANTIES, EXPRESS OR IMPLIED, INCLUDING ANY IMPLIED WARRANTIES OF MERCHANTABILITY OR FITNESS FOR A PARTICULAR PURPOSE.

© 2024 CARFAX, Inc., part of S&P Global. All rights reserved.  
7/27/24 7:06:00 AM (CDT)

**I have reviewed and received a copy of the CARFAX Vehicle History Report for this 2005 VOLVO V70 vehicle (VIN: YV1SW612952518057), which is based on information supplied to CARFAX and available as of 7/27/24 at 8:06 AM (EDT).**

\_\_\_\_\_  
Customer Signature

\_\_\_\_\_  
Date

\_\_\_\_\_  
Dealer Signature

\_\_\_\_\_  
Date