



### History-Based Value Report

#### History events affecting this vehicle's value



Service History



Personal Vehicle



Accident Reported

**\$7,340 Retail Value**



### Vehicle History Report™

US \$44.99

#### 2003 HONDA ODYSSEY EX

VIN: 5FNRL18603B139080  
 VAN  
 3.5L V6 F SOHC  
 GASOLINE  
 FRONT WHEEL DRIVE

#### Accident reported: moderate damage



MINOR      MODERATE      SEVERE



**53** Service history records



**2** Previous owners



Personal vehicle



**89,256** Last reported odometer reading



This CARFAX Vehicle History Report is based only on information supplied to CARFAX and available as of 7/13/24 at 6:30:21 AM (CDT). Other information about this vehicle, including problems, may not have been reported to CARFAX. Use this report as one important tool, along with a vehicle inspection and test drive, to make a better decision about your next used car.

**CARFAX** Accident / Damage History

Not all accidents / issues are reported to CARFAX

Event 1

11/25/2013

**Accident reported: moderate damage with another motor vehicle**

Airbags did not deploy

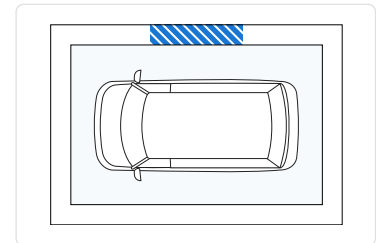
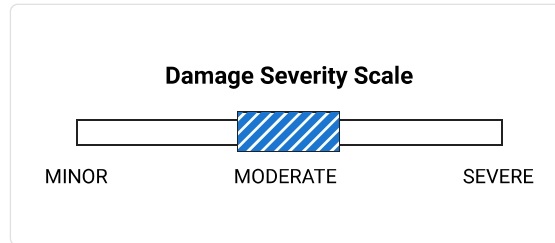

Event 2

01/09/2018

**Accident reported: minor damage**

Involving front or side impact with another motor vehicle

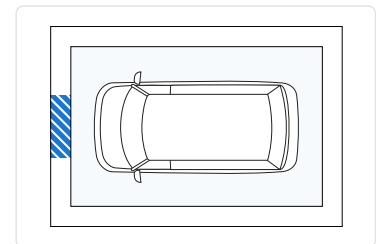
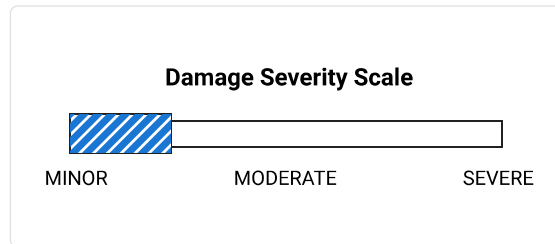

Event 3

06/06/2024

**Damage reported**

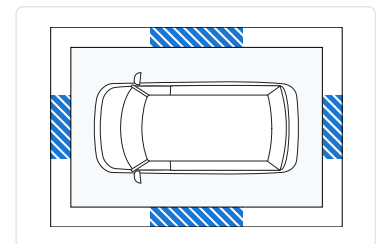

**CARFAX** Additional History

Not all accidents / issues are reported to CARFAX

**Owner 1**

**Owner 2**

**Total Loss**

No total loss reported to CARFAX.

No Issues Reported

No Issues Reported

<p><b>Structural Damage</b>                  CARFAX recommends that you have this vehicle inspected by a collision repair specialist.</p>	<p><input checked="" type="checkbox"/> No Issues Reported</p>	<p><input checked="" type="checkbox"/> No Issues Reported</p>
<p><b>Airbag Deployment</b>                  No airbag deployment reported to CARFAX.</p>	<p><input checked="" type="checkbox"/> No Issues Reported</p>	<p><input checked="" type="checkbox"/> No Issues Reported</p>
<p><b>Odometer Check</b>                  No indication of an odometer rollback.</p>	<p><input checked="" type="checkbox"/> No Issues Indicated</p>	<p><input checked="" type="checkbox"/> No Issues Indicated</p>
<p><b>Accident / Damage</b>                  Accidents reported: 11/25/2013 and 01/09/2018. Damage reported: 06/06/2024.</p>	<p>Accident Reported</p>	<p>No New Issues Reported</p>
<p><b>Manufacturer Recall</b>                  No open recalls reported to CARFAX. Check with an authorized Honda dealer for any open recalls.</p>	<p><input checked="" type="checkbox"/> No Recalls Reported</p>	<p><input checked="" type="checkbox"/> No Recalls Reported</p>
<p><b>Basic Warranty</b>                  Original warranty estimated to have expired.</p>	<p>Warranty Expired</p>	<p>Warranty Expired</p>

 <b>Title History</b>	Owner 1	Owner 2
<p><b>Damage Brands</b>                  Salvage   Junk   Rebuilt   Fire   Flood   Hail   Lemon</p>	No Problem	No Problem
<p><b>Odometer Brands</b>                  Not Actual Mileage   Exceeds Mechanical Limits</p>	No Problem	No Problem

 <b>Ownership History</b> The number of owners is estimated	Owner 1	Owner 2
Year purchased	2003	2024
Type of owner	Personal	Personal
Estimated length of ownership	20 yrs. 9 mo.	19 days
Owned in the following states/provinces	Georgia, Kentucky	Michigan
Estimated miles driven per year	4,385/yr	---
Last reported odometer reading	89,256	---

 **Detailed History**







**Owner 1**  
Purchased: 2003













**Low mileage!** This owner drove less than the industry average of 15,000 miles per year.





Personal Vehicle  
4,385 mi/yr

Date	Mileage	Source	Comments
08/19/2003		Georgia Motor Vehicle Dept.	<b>Vehicle purchase reported</b> Titled or registered as personal vehicle
09/10/2003	98	Georgia Motor Vehicle Dept. Grovetown, GA Title #774787032533006	<b>Title issued or updated</b> Registration issued or renewed First owner reported Loan or lien reported
01/11/2007		Georgia Motor Vehicle Dept. Grovetown, GA Title #774787032533006	<b>Registration issued or renewed</b> Vehicle color noted as Gray
01/22/2008		Georgia Motor Vehicle Dept. Grovetown, GA Title #774787032533006	<b>Registration issued or renewed</b> Vehicle color noted as Gray
01/06/2009		Georgia Motor Vehicle Dept. Grovetown, GA Title #774787032533006	<b>Registration issued or renewed</b> Vehicle color noted as Gray
10/29/2009	48,679	Kentucky Motor Vehicle Dept. Louisville, KY Title #093020560692	<b>Title or registration issued</b> Registration updated when owner moved the vehicle to a new location Vehicle color noted as Gray
01/12/2010	50,160	Valvoline Instant Oil Change Louisville, KY 502-495-6222 vioc.com ★ <b>4.6 / 5.0</b> 77 Verified Reviews ❤️ <b>113</b> Customer Favorites	 <b>Vehicle serviced</b> Oil and filter changed Air filter replaced

07/13/2010	52,543	Valvoline Instant Oil Change Louisville, KY 502-495-6222 vioc.com ★ <b>4.6 / 5.0</b> 77 Verified Reviews ♥ <b>113</b> Customer Favorites		<b>Vehicle serviced</b> Oil and filter changed Front wiper blades/refills replaced
07/22/2010		Kentucky Motor Vehicle Dept. Louisville, KY Title #093020560692		<b>Registration issued or renewed</b> Vehicle color noted as Gray
12/03/2010	55,529	Sam Swope Honda World Louisville, KY 502-499-5040 samswopehondaworld.com ★ <b>4.3 / 5.0</b> 52 Verified Reviews		<b>Vehicle serviced</b> Maintenance inspection completed Interior trim checked
12/03/2010		Honda World Louisville, KY 502-499-5040 louisvillehondaworld.com ★ <b>4.6 / 5.0</b> 835 Verified Reviews ♥ <b>11,597</b> Customer Favorites		<b>Vehicle serviced</b> Maintenance inspection completed Interior trim checked
04/07/2011	56,857	Sam Swope Honda World Louisville, KY 502-499-5040 samswopehondaworld.com ★ <b>4.3 / 5.0</b> 52 Verified Reviews		<b>Vehicle serviced</b> Recommended maintenance performed Maintenance inspection completed Front brake pads replaced Transmission serviced Oil and filter changed Automatic transmission serviced Tires rotated
04/07/2011		Honda World Louisville, KY 502-499-5040 louisvillehondaworld.com ★ <b>4.6 / 5.0</b> 835 Verified Reviews ♥ <b>11,597</b> Customer Favorites		<b>Vehicle serviced</b> Recommended maintenance performed Maintenance inspection completed Front brake pads replaced Transmission serviced Oil and filter changed Tires rotated Automatic transmission serviced

07/19/2011		Kentucky Motor Vehicle Dept. Louisville, KY Title #093020560692		<b>Registration issued or renewed</b> Vehicle color noted as Gray
07/28/2011	58,661	Sam Swope Honda World Louisville, KY 502-499-5040 samswopehondaworld.com ★ <b>4.3 / 5.0</b> 52 Verified Reviews		<b>Vehicle serviced</b> Maintenance inspection completed Rear brake shoes replaced Timing belt replaced Rear brake pads replaced
07/28/2011		Honda World Louisville, KY 502-499-5040 louisvillehondaworld.com ★ <b>4.6 / 5.0</b> 835 Verified Reviews ❤️ <b>11,597</b> Customer Favorites		<b>Vehicle serviced</b> Maintenance inspection completed Timing belt replaced Rear brake shoes replaced Rear brake pads replaced
01/18/2012	60,669	Sam Swope Honda World Louisville, KY 502-499-5040 samswopehondaworld.com ★ <b>4.3 / 5.0</b> 52 Verified Reviews		<b>Vehicle serviced</b> Recommended maintenance performed Maintenance inspection completed Brake fluid flushed/changed Power steering fluid flushed/changed Steering/suspension checked
01/18/2012		Honda World Louisville, KY 502-499-5040 louisvillehondaworld.com ★ <b>4.6 / 5.0</b> 835 Verified Reviews ❤️ <b>11,597</b> Customer Favorites		<b>Vehicle serviced</b> Maintenance inspection completed Recommended maintenance performed Power steering fluid flushed/changed Brake fluid flushed/changed Steering/suspension checked
03/01/2012	61,076	Sam Swope Honda World Louisville, KY 502-499-5040 samswopehondaworld.com ★ <b>4.3 / 5.0</b> 52 Verified Reviews		<b>Vehicle serviced</b> Maintenance inspection completed Oil and filter changed Tire(s) balanced Tires rotated

03/01/2012		<p>Honda World Louisville, KY 502-499-5040 louisvillehondaworld.com</p> <p>★ <b>4.6 / 5.0</b> 835 Verified Reviews ♥ <b>11,597</b> Customer Favorites</p>	 <p><b>Vehicle serviced</b> Maintenance inspection completed Oil and filter changed Tire(s) balanced Tires rotated</p>
07/17/2012		<p>Kentucky Motor Vehicle Dept. Louisville, KY Title #093020560692</p>	<p><b>Registration issued or renewed</b> Vehicle color noted as Gray</p>
11/23/2012	64,081	<p>Sam Swope Honda World Louisville, KY 502-499-5040 samswopehondaworld.com</p> <p>★ <b>4.3 / 5.0</b> 52 Verified Reviews</p>	 <p><b>Vehicle serviced</b> Recommended maintenance performed Maintenance inspection completed Battery serviced Battery/charging system checked</p>
11/23/2012		<p>Honda World Louisville, KY 502-499-5040 louisvillehondaworld.com</p> <p>★ <b>4.6 / 5.0</b> 835 Verified Reviews ♥ <b>11,597</b> Customer Favorites</p>	 <p><b>Vehicle serviced</b> Recommended maintenance performed Maintenance inspection completed Battery serviced Battery/charging system checked</p>
02/06/2013	64,821	<p>Bachman Auto Group Louisville, KY 502-499-6161 bachmanautogroup.com</p> <p>★ <b>4.4 / 5.0</b> 601 Verified Reviews ♥ <b>8,786</b> Customer Favorites</p>	 <p><b>Vehicle serviced</b></p>
03/01/2013	65,248	<p>Sam Swope Honda World Louisville, KY 502-499-5040 samswopehondaworld.com</p> <p>★ <b>4.3 / 5.0</b> 52 Verified Reviews</p>	 <p><b>Vehicle serviced</b> Maintenance inspection completed Oil and filter changed</p>

03/01/2013	Honda World Louisville, KY 502-499-5040 louisvillehondaworld.com		<b>Vehicle serviced</b> Maintenance inspection completed Oil and filter changed
★ <b>4.6 / 5.0</b> 835 Verified Reviews ❤️ <b>11,597</b> Customer Favorites			
07/24/2013	Kentucky Motor Vehicle Dept. Louisville, KY Title #093020560692	<b>Registration issued or renewed</b> Registration updated when owner moved the vehicle to a new location Vehicle color noted as Gray	
11/12/2013 68,570	Sam Swope Honda World Louisville, KY 502-499-5040 samswopehondaworld.com		<b>Vehicle serviced</b> Recommended maintenance performed Maintenance inspection completed Oil and filter changed
★ <b>4.3 / 5.0</b> 52 Verified Reviews			
11/12/2013	Honda World Louisville, KY 502-499-5040 louisvillehondaworld.com		<b>Vehicle serviced</b> Recommended maintenance performed Maintenance inspection completed Oil and filter changed
★ <b>4.6 / 5.0</b> 835 Verified Reviews ❤️ <b>11,597</b> Customer Favorites			
11/21/2013 68,918	Sam Swope Honda World Louisville, KY 502-499-5040 samswopehondaworld.com		<b>Vehicle serviced</b> Maintenance inspection completed Airbag system checked
★ <b>4.3 / 5.0</b> 52 Verified Reviews			
11/21/2013	Honda World Louisville, KY 502-499-5040 louisvillehondaworld.com		<b>Vehicle serviced</b> Maintenance inspection completed Airbag system checked
★ <b>4.6 / 5.0</b> 835 Verified Reviews ❤️ <b>11,597</b> Customer Favorites			



11/25/2013

Damage Report



**Accident reported: moderate damage with another motor vehicle**

Damage to right side  
Airbags did not deploy



**CARFAX HAS THE MOST ACCIDENT & DAMAGE INFORMATION**

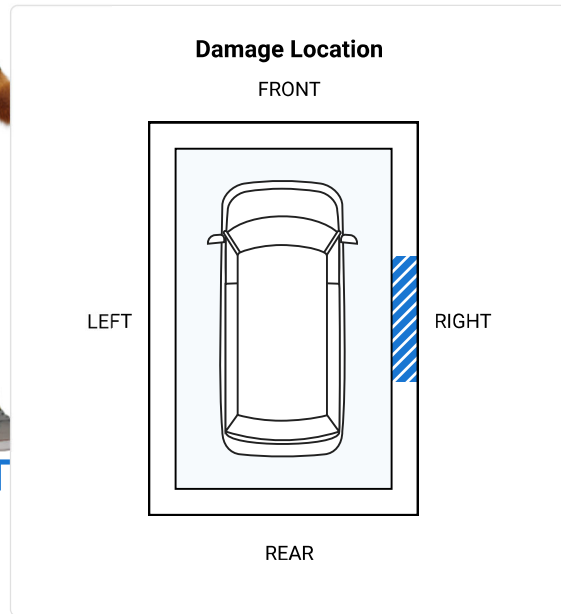
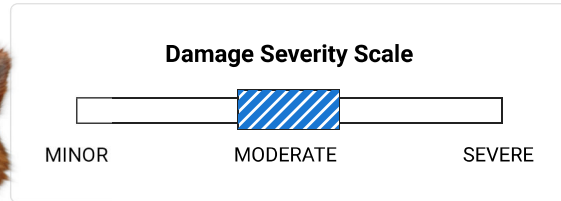

12/18/2013

Ken Towery's Tire & Auto Care  
Louisville, KY  
★ 4.4 / 5.0  
25 Verified Reviews



**Vehicle serviced**

Alignment checked  
Tire(s) balanced  
Four wheel alignment performed

12/31/2013 68,963

Bachman Auto Group  
Louisville, KY  
502-499-6161  
bachmanautogroup.com  
★ 4.4 / 5.0  
601 Verified Reviews  
❤️ 8,786 Customer Favorites



**Vehicle serviced**

Window replaced





04/01/2014 70,146





Sam Swope Honda World  
Louisville, KY  
502-499-5040  
samswopehondaworld.com  
★ 4.3 / 5.0  
52 Verified Reviews











**Vehicle serviced**

High mount brake light bulb replaced  
Lights checked

04/01/2014	Honda World Louisville, KY 502-499-5040 louisvillehondaworld.com		<b>Vehicle serviced</b> High mount brake light bulb replaced Lights checked
★ <b>4.6 / 5.0</b> 835 Verified Reviews ❤️ <b>11,597</b> Customer Favorites			
07/03/2014 71,257	Sam Swope Honda World Louisville, KY 502-499-5040 samswopehondaworld.com		<b>Vehicle serviced</b> Maintenance inspection completed Recommended maintenance performed Oil and filter changed
★ <b>4.3 / 5.0</b> 52 Verified Reviews			
07/03/2014	Honda World Louisville, KY 502-499-5040 louisvillehondaworld.com		<b>Vehicle serviced</b> Recommended maintenance performed Maintenance inspection completed Oil and filter changed
★ <b>4.6 / 5.0</b> 835 Verified Reviews ❤️ <b>11,597</b> Customer Favorites			
07/16/2014	Kentucky Motor Vehicle Dept. Louisville, KY Title #093020560692	<b>Registration issued or renewed</b> Vehicle color noted as Gray	
03/25/2015 73,470	Sam Swope Honda World Louisville, KY 502-499-5040 samswopehondaworld.com		<b>Vehicle serviced</b> Maintenance inspection completed Airbag replaced
★ <b>4.3 / 5.0</b> 52 Verified Reviews			
03/25/2015	Honda World Louisville, KY 502-499-5040 louisvillehondaworld.com		<b>Vehicle serviced</b> Maintenance inspection completed Airbag replaced
★ <b>4.6 / 5.0</b> 835 Verified Reviews ❤️ <b>11,597</b> Customer Favorites			

04/17/2015 73,571	Sam Swope Honda World Louisville, KY 502-499-5040 samswopehondaworld.com		<b>Vehicle serviced</b> Maintenance inspection completed Oil and filter changed Tire(s) balanced Tires rotated
★ 4.3 / 5.0 52 Verified Reviews			
04/17/2015	Honda World Louisville, KY 502-499-5040 louisvillehondaworld.com		<b>Vehicle serviced</b> Maintenance inspection completed Oil and filter changed Tire(s) balanced Tires rotated
★ 4.6 / 5.0 835 Verified Reviews ❤️ 11,597 Customer Favorites			
05/14/2015 73,829	Sam Swope Honda World Louisville, KY 502-499-5040 samswopehondaworld.com		<b>Vehicle serviced</b> Maintenance inspection completed Cabin air filter replaced/cleaned
★ 4.3 / 5.0 52 Verified Reviews			
05/14/2015	Honda World Louisville, KY 502-499-5040 louisvillehondaworld.com		<b>Vehicle serviced</b> Maintenance inspection completed Cabin air filter replaced/cleaned
★ 4.6 / 5.0 835 Verified Reviews ❤️ 11,597 Customer Favorites			
07/21/2015	Kentucky Motor Vehicle Dept. Louisville, KY Title #093020560692	<b>Registration issued or renewed</b> Vehicle color noted as Gray	
10/21/2015 75,806	Sam Swope Honda World Louisville, KY 502-499-5040 samswopehondaworld.com		<b>Vehicle serviced</b> Maintenance inspection completed Recommended maintenance performed
★ 4.3 / 5.0 52 Verified Reviews			

10/21/2015	<p>Honda World Louisville, KY 502-499-5040 louisvillehondaworld.com</p> <p>★ <b>4.6 / 5.0</b> 835 Verified Reviews ♥ <b>11,597</b> Customer Favorites</p>		<p><b>Vehicle serviced</b> Recommended maintenance performed Maintenance inspection completed</p>
11/03/2015 76,081	<p>Sam Swope Honda World Louisville, KY 502-499-5040 samswopehondaworld.com</p> <p>★ <b>4.3 / 5.0</b> 52 Verified Reviews</p>		<p><b>Vehicle serviced</b> Maintenance inspection completed Airbag computer/module replaced</p>
11/03/2015	<p>Honda World Louisville, KY 502-499-5040 louisvillehondaworld.com</p> <p>★ <b>4.6 / 5.0</b> 835 Verified Reviews ♥ <b>11,597</b> Customer Favorites</p>		<p><b>Vehicle serviced</b> Maintenance inspection completed Airbag computer/module replaced</p>
02/15/2016 76,769	<p>Honda World Louisville, KY 502-499-5040 louisvillehondaworld.com</p> <p>★ <b>4.6 / 5.0</b> 835 Verified Reviews ♥ <b>11,597</b> Customer Favorites</p>		<p><b>Vehicle serviced</b> Recommended maintenance performed Maintenance inspection completed Brake fluid flushed/changed Rear wiper blade replaced Wiper(s) replaced Oil and filter changed Electrical system checked Battery serviced Battery replaced</p>
07/28/2016 78,999	<p>Honda World Louisville, KY 502-499-5040 louisvillehondaworld.com</p> <p>★ <b>4.6 / 5.0</b> 835 Verified Reviews ♥ <b>11,597</b> Customer Favorites</p>		<p><b>Vehicle serviced</b> Maintenance inspection completed Tire(s) balanced Tires rotated Tire(s) replaced Two tires replaced</p>

07/28/2016		Kentucky Motor Vehicle Dept. Louisville, KY Title #093020560692		<b>Registration issued or renewed</b> Vehicle color noted as Gray
08/06/2016	79,037	Honda World Louisville, KY 502-499-5040 louisvillehondaworld.com  ★ 4.6 / 5.0 835 Verified Reviews ♥ 11,597 Customer Favorites		<b>Vehicle serviced</b> Maintenance inspection completed Tire(s) replaced Two tires replaced
02/10/2017	80,504	Honda World Louisville, KY 502-499-5040 louisvillehondaworld.com  ★ 4.6 / 5.0 835 Verified Reviews ♥ 11,597 Customer Favorites		<b>Vehicle serviced</b> Maintenance inspection completed Tires rotated Oil and filter changed Battery replaced
02/21/2017	80,532	Honda World Louisville, KY 502-499-5040 louisvillehondaworld.com  ★ 4.6 / 5.0 835 Verified Reviews ♥ 11,597 Customer Favorites		<b>Vehicle serviced</b> Maintenance inspection completed Exterior trim checked Drivability/performance checked
07/19/2017		Kentucky Motor Vehicle Dept. Louisville, KY Title #093020560692		<b>Registration issued or renewed</b> Vehicle color noted as Gray
08/31/2017	81,584	Honda World Louisville, KY 502-499-5040 louisvillehondaworld.com  ★ 4.6 / 5.0 835 Verified Reviews ♥ 11,597 Customer Favorites		<b>Vehicle serviced</b> Maintenance inspection completed Oil and filter changed

01/09/2018

Damage Report



**Accident reported: minor damage**  
 Involving front or side impact with another motor vehicle  
 Damage to front



**CARFAX HAS THE MOST ACCIDENT & DAMAGE INFORMATION**

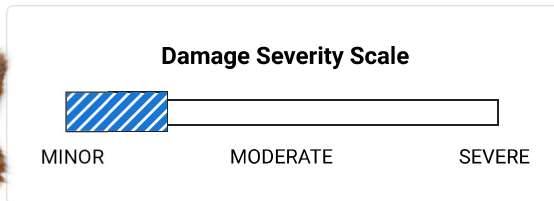

07/23/2018

Kentucky  
 Motor Vehicle Dept.  
 Louisville, KY  
 Title #093020560692

**Registration issued or renewed**  
 Vehicle color noted as Gray





10/30/2018 83,475





Honda World  
 Louisville, KY  
 502-499-5040  
 louisvillehondaworld.com

★ **4.6 / 5.0**  
 835 Verified Reviews  
 ❤️ **11,597** Customer Favorites



**Vehicle serviced**  
 Maintenance inspection completed  
 Oil and filter changed  
 Tire(s) balanced  
 Tires rotated  
 Fluids checked  
 Power steering fluid flushed/changed

04/23/2019 84,194	Honda World Louisville, KY 502-499-5040 louisvillehondaworld.com		<b>Vehicle serviced</b> Maintenance inspection completed Airbag system checked Seatbelt buckle replaced Left front seatbelt buckle replaced
★ 4.6 / 5.0 835 Verified Reviews ❤️ 11,597 Customer Favorites			
07/17/2019	Kentucky Motor Vehicle Dept. Louisville, KY Title #093020560692	<b>Registration issued or renewed</b> Vehicle color noted as Gray	
07/24/2019 84,678	Honda World Louisville, KY 502-499-5040 louisvillehondaworld.com		<b>Vehicle serviced</b> Maintenance inspection completed Engine checked
★ 4.6 / 5.0 835 Verified Reviews ❤️ 11,597 Customer Favorites			
03/03/2020 85,449	Honda World Louisville, KY 502-499-5040 louisvillehondaworld.com		<b>Vehicle serviced</b> Maintenance inspection completed A/C and heating system checked
★ 4.6 / 5.0 835 Verified Reviews ❤️ 11,597 Customer Favorites			
06/12/2020 85,618	Honda World Louisville, KY 502-499-5040 louisvillehondaworld.com		<b>Vehicle serviced</b> Maintenance inspection completed Oil and filter changed One tire mounted One tire balanced
★ 4.6 / 5.0 835 Verified Reviews ❤️ 11,597 Customer Favorites			
07/22/2020	Kentucky Motor Vehicle Dept. Louisville, KY Title #093020560692	<b>Registration issued or renewed</b> Vehicle color noted as Gray	

07/23/2021		Kentucky Motor Vehicle Dept. Louisville, KY Title #093020560692		<b>Registration issued or renewed</b> Vehicle color noted as Gray
08/24/2021	86,761	Valvoline Instant Oil Change Louisville, KY 502-495-6222 vioc.com ★ <b>4.6 / 5.0</b> 77 Verified Reviews ♥ <b>113</b> Customer Favorites		<b>Vehicle serviced</b> Oil and filter changed
04/26/2022	87,563	Honda World Louisville, KY 502-499-5040 louisvillehondaworld.co m ★ <b>4.6 / 5.0</b> 835 Verified Reviews ♥ <b>11,597</b> Customer Favorites		<b>Vehicle serviced</b> Maintenance inspection completed Oil and filter changed Tire(s) balanced Tires rotated One tire mounted One tire balanced Brake fluid flushed/changed Fluids checked Four tires balanced Power steering fluid flushed/changed
07/25/2022		Kentucky Motor Vehicle Dept. Louisville, KY Title #093020560692		<b>Registration issued or renewed</b> Vehicle color noted as Gray
04/06/2023	88,898	Honda World Louisville, KY 502-499-5040 louisvillehondaworld.co m ★ <b>4.6 / 5.0</b> 835 Verified Reviews ♥ <b>11,597</b> Customer Favorites		<b>Vehicle serviced</b> Maintenance inspection completed Oil and filter changed Cabin air filter replaced/cleaned
05/08/2023	89,041	Honda World Louisville, KY 502-499-5040 louisvillehondaworld.co m ★ <b>4.6 / 5.0</b> 835 Verified Reviews ♥ <b>11,597</b> Customer Favorites		<b>Vehicle serviced</b> Battery replaced



07/20/2023	Kentucky Motor Vehicle Dept. Louisville, KY Title #093020560692	<b>Registration issued or renewed</b> Vehicle color noted as Gray
------------	--	--

12/20/2023	89,256	Honda World Louisville, KY 502-499-5040 louisvillehondaworld.com  ★ <b>4.6 / 5.0</b> 835 Verified Reviews ❤️ <b>11,597</b> Customer Favorites	 <b>Vehicle serviced</b> Maintenance inspection completed Oil and filter changed
------------	--------	--	---

05/24/2024	Kenturcky Motor Vehicle Dept. Louisville, KY Title #093020560692	<b>Registration issued or renewed</b>
------------	---	---------------------------------------

06/06/2024	Damage Report	 <b>Damage reported</b> Damage to front Damage to rear Damage to right side Damage to left side
------------	---------------	--

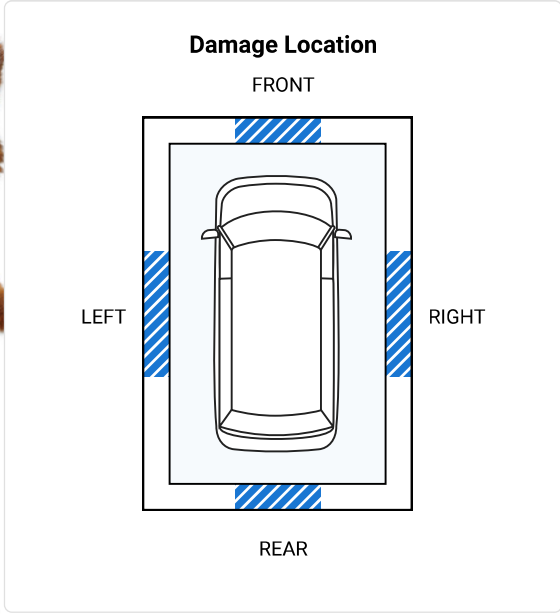

**CARFAX HAS THE MOST ACCIDENT & DAMAGE INFORMATION**



Not all damage is caused by an accident. Get the car inspected before you buy. [Learn More](#)



### Owner 2

Purchased: 2024

Personal Vehicle

Date	Mileage	Source	Comments
06/24/2024		Michigan Motor Vehicle Dept.	<b>Vehicle purchase reported</b>
06/27/2024		Michigan Motor Vehicle Dept. Kalamazoo, MI Title #MI0021687266	<b>Title issued or updated</b> New owner reported Exempt from odometer reporting

Have Questions? Consumers, please visit our Help Center at [www.carfax.com](http://www.carfax.com). Dealers or Subscribers, please visit our Help Center at [www.carfaxonline.com](http://www.carfaxonline.com).



## Glossary

### Accident Indicator

CARFAX receives information about accidents in all 50 states, the District of Columbia and Canada.

Not every accident is reported to CARFAX. As details about the accident become available, those additional details are added to the CARFAX Vehicle History Report. CARFAX recommends that you have this vehicle inspected by a qualified mechanic.

- According to the National Safety Council, Injury Facts, 2021 edition, 5% of the 276 million registered vehicles in the U.S. were involved in an accident in 2019. Over 77% of these were considered minor or moderate.
- This CARFAX Vehicle History Report is based only on information supplied to CARFAX and available as of 7/13/24 at 6:30:21 AM (CDT). Other information about this vehicle, including problems, may not have been reported to CARFAX. Use this report as one important tool, along with a vehicle inspection and test drive, to make a better decision about your next used car.

### Damage Indicator

Damage can be a result of many different types of events. Examples include contact with objects (other cars, trees, traffic signs, road debris, etc), vandalism, or weather-related events. Not every damage event is reported to CARFAX. As details about the damage event become available, those additional details are added to the CARFAX Vehicle History Report. CARFAX recommends that you have this vehicle inspected by a qualified mechanic.

- This CARFAX Vehicle History Report is based only on information supplied to CARFAX and available as of 7/13/24 at 6:30:21 AM (CDT). Other information about this vehicle, including problems, may not have been reported to CARFAX. Use this report as one important tool, along with a vehicle inspection and test drive, to make a better decision about your next used car.

### Damage Severity

Damage events result in one of the following severity levels:

- **Minor:** Generally, minor damage is cosmetic (including dents or scratches), may only require reconditioning, and typically does not compromise a vehicle's operation and/or safety.

- Moderate: Moderate damage may affect multiple components of the vehicle and may impair the vehicle's operation and/or safety.
- Severe: Severe damage usually affects multiple components of the vehicle and is likely to compromise the vehicle's operation and/or safety.

CARFAX recommends getting a pre-purchase inspection at a certified collision repair facility.

**First Owner**

When the first owner(s) obtains a title from a Department of Motor Vehicles as proof of ownership.

**New Owner Reported**

When a vehicle is sold to a new owner, the Title must be transferred to the new owner(s) at a Department of Motor Vehicles.

**Ownership History**

CARFAX defines an owner as an individual or business that possesses and uses a vehicle. Not all title transactions represent changes in ownership. To provide estimated number of owners, CARFAX proprietary technology analyzes all the events in a vehicle history. Estimated ownership is available for vehicles manufactured after 1991 and titled solely in the US including Puerto Rico. Dealers sometimes opt to take ownership of a vehicle and are required to in the following states: Maine, Massachusetts, New Jersey, Ohio, Oklahoma, Pennsylvania and South Dakota. Please consider this as you review a vehicle's estimated ownership history.

**Title Issued**

A state issues a title to provide a vehicle owner with proof of ownership. Each title has a unique number. Each title or registration record on a CARFAX report does not necessarily indicate a change in ownership. In Canada, a registration and bill of sale are used as proof of ownership.

Follow Us:



[facebook.com/CARFAX](https://facebook.com/CARFAX)



[@CARFAXinc](https://twitter.com/CARFAXinc)



About CARFAX

CARFAX DEPENDS ON ITS SOURCES FOR THE ACCURACY AND RELIABILITY OF ITS INFORMATION. THEREFORE, NO RESPONSIBILITY IS ASSUMED BY CARFAX OR ITS AGENTS FOR ERRORS OR OMISSIONS IN THIS REPORT. CARFAX FURTHER EXPRESSLY DISCLAIMS ALL WARRANTIES, EXPRESS OR IMPLIED, INCLUDING ANY IMPLIED WARRANTIES OF MERCHANTABILITY OR FITNESS FOR A PARTICULAR PURPOSE.

© 2024 CARFAX, Inc., part of S&P Global. All rights reserved.  
7/13/24 6:30:21 AM (CDT)

**I have reviewed and received a copy of the CARFAX Vehicle History Report for this 2003 HONDA ODYSSEY vehicle (VIN: 5FNRL18603B139080), which is based on information supplied to CARFAX and available as of 7/13/24 at 7:30 AM (EDT).**

\_\_\_\_\_  
Customer Signature

\_\_\_\_\_  
Date

\_\_\_\_\_  
Dealer Signature

\_\_\_\_\_  
Date