







History-Based Value Report

\$14,830

CARFAX Retail Value

History events affecting this vehicle's value

-   1-Owner Vehicle
-   Minor Damage



Vehicle History Report™

US \$44.99

**2015 CHEVROLET
TAHOE POLICE**

VIN: 1GNSK2EC9FR654752
4 DOOR WAGON/SPORT
UTILITY
5.3L V8 F OHV 16V
GASOLINE
REAR WHEEL DRIVE W/ 4X4

Accident reported: minor damage

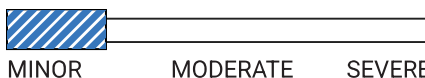

1 Service history record



CARFAX 1-Owner vehicle



Last owned in Michigan



7 Last reported odometer reading



This CARFAX Vehicle History Report is based only on information supplied to CARFAX and available as of 2/28/25 at 11:07:24 AM (CST). Other information about this vehicle, including problems, may not have been reported to CARFAX. Use this report as one important tool, along with a vehicle inspection and test drive, to make a better decision about your next used car.



CARFAX Accident / Damage History

Not all accidents / issues are reported to CARFAX

Event 1

02/18/2016

**Accident reported:
minor damage**

It hit a deer
It hit an animal
Functional damage
reported

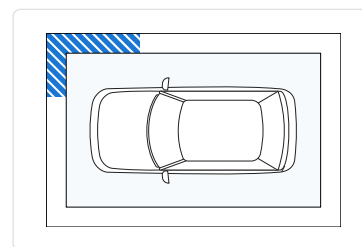
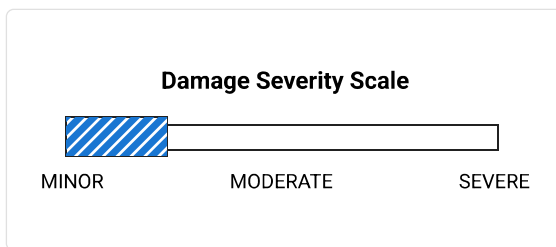

Event 2

03/06/2016

**Accident reported:
minor damage**

It hit an animal

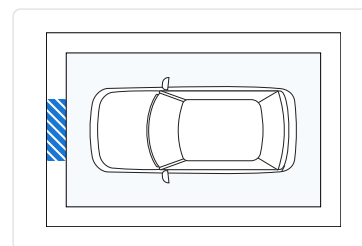
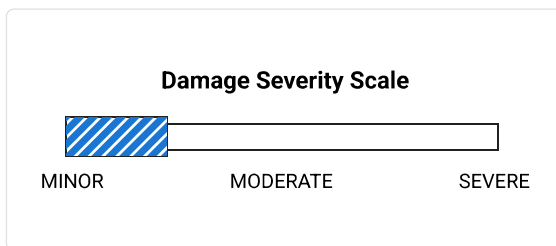

CARFAX Additional History

Not all accidents / issues are reported to CARFAX

Owner 1

Total Loss

No total loss reported to CARFAX.

✓ No Issues Reported

Structural Damage

CARFAX recommends that you have this vehicle inspected by a collision repair specialist.

✓ No Issues Reported

Airbag Deployment

No airbag deployment reported to CARFAX.

✓ No Issues Reported

Odometer Check

No indication of an odometer rollback.

✓ No Issues Indicated

Accident / Damage

Accidents reported: 02/18/2016 and 03/06/2016.

Minor Damage

Manufacturer Recall

No open recalls reported to CARFAX. Check for open recalls on GM vehicles at recalls.gm.com.

✓ No Recalls Reported

Basic Warranty Original warranty estimated to have expired.	Warranty Expired
---	-------------------------



CARFAX Title History CARFAX guarantees the information in this section	Owner 1
Damage Brands Salvage Junk Rebuilt Fire Flood Hail Lemon	<input checked="" type="checkbox"/> Guaranteed No Problem
Odometer Brands Not Actual Mileage Exceeds Mechanical Limits	<input checked="" type="checkbox"/> Guaranteed No Problem
 GUARANTEED - None of these title problems were reported by a U.S. state Department of Motor Vehicles (DMV). If you find that any of these title problems were reported by a DMV and not included in this report, you may qualify. View Terms View Certificate	

CARFAX Ownership History The number of owners is estimated	Owner 1
Year purchased	2015
Type of owner	---
Estimated length of ownership	9 yrs. 8 mo.
Owned in the following states/provinces	Michigan
Estimated miles driven per year	---
Last reported odometer reading	7



CARFAX Detailed History			
 Owner 1 Purchased: 2015			
Date	Mileage	Source	Comments
04/21/2015		Shaheen Chevrolet Lansing, MI 517-394-0330 shaheenchevrolet.com ★ 4.6 / 5.0 852 Verified Reviews ❤️ 395 Customer Favorites	Vehicle offered for sale

04/30/2015 7	Shaheen Chevrolet Lansing, MI 517-277-6588 shaheenchevrolet.com	 Vehicle serviced Pre-delivery inspection completed Vehicle washed/detailed
05/05/2015	Dealer Inventory	Vehicle offered for sale
06/01/2015	Michigan Motor Vehicle Dept. Kalamazoo, MI Title #228D1520134	Title issued or updated First owner reported

 **4.6 / 5.0**
 852 Verified Reviews
 **395** Customer Favorites

02/18/2016	Damage Report	 Accident reported: minor damage It hit a deer It hit an animal Damage to right front Functional damage reported
------------	---------------	--



CARFAX HAS THE MOST ACCIDENT & DAMAGE INFORMATION

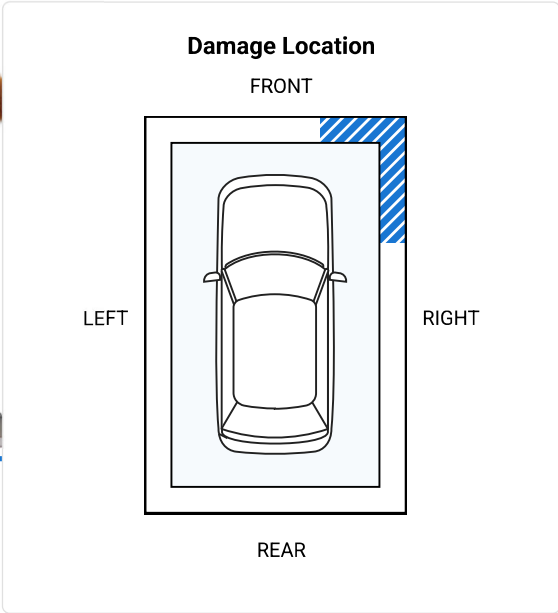
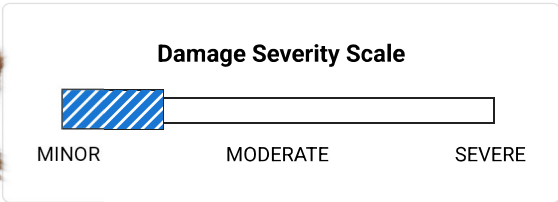

Minor damage is usually cosmetic, including dents or scratches to the vehicle body.

03/06/2016

Damage Report

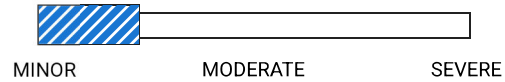
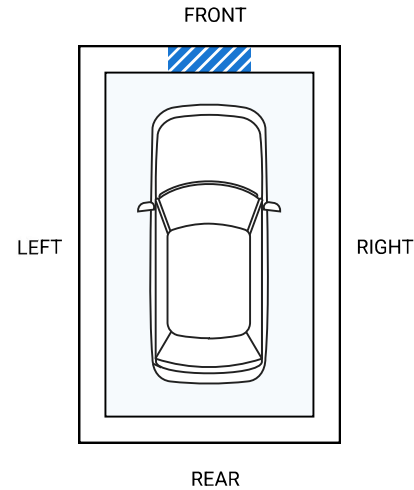
**Accident reported: minor damage**It hit an animal
Damage to front**CARFAX HAS THE MOST
ACCIDENT & DAMAGE
INFORMATION****Damage Severity Scale****Damage Location**

Minor damage is usually cosmetic, including dents or scratches to the vehicle body.

Have Questions? Consumers, please visit our Help Center at www.carfax.com. Dealers or Subscribers, please visit our Help Center at www.carfaxonline.com.

**Glossary****Accident Indicator**

CARFAX receives information about accidents in all 50 states, the District of Columbia and Canada.

Not every accident is reported to CARFAX. As details about the accident become available, those additional details are added to the CARFAX Vehicle History Report. CARFAX recommends that you have this vehicle inspected by a qualified mechanic.

- According to the National Safety Council, Injury Facts, 2021 edition, 5% of the 276 million registered vehicles in the U.S. were involved in an accident in 2019. Over 77% of these were considered minor or moderate.
- This CARFAX Vehicle History Report is based only on information supplied to CARFAX and available as of 2/28/25 at 11:07:24 AM (CST). Other information about this vehicle, including problems, may not have been reported to CARFAX. Use this report as one important tool, along with a vehicle inspection and test drive, to make a better decision about your next used car.

Damage Severity

Damage events result in one of the following severity levels:

- **Minor:** Generally, minor damage is cosmetic (including dents or scratches), may only require reconditioning, and typically does not compromise a vehicle's operation and/or safety.
- **Moderate:** Moderate damage may affect multiple components of the vehicle and may impair the vehicle's operation and/or safety.
- **Severe:** Severe damage usually affects multiple components of the vehicle and is likely to compromise the vehicle's operation and/or safety.

CARFAX recommends getting a pre-purchase inspection at a certified collision repair facility.

First Owner

When the first owner(s) obtains a title from a Department of Motor Vehicles as proof of ownership.

Ownership History

CARFAX defines an owner as an individual or business that possesses and uses a vehicle. Not all title transactions represent changes in ownership. To provide estimated number of owners, CARFAX proprietary technology analyzes all the events in a vehicle history. Estimated ownership is available for vehicles manufactured after 1991 and titled solely in the US including Puerto Rico. Dealers sometimes opt to take ownership of a vehicle and are required to in the following states: Maine, Massachusetts, New Jersey, Ohio, Oklahoma, Pennsylvania and South Dakota. Please consider this as you review a vehicle's estimated ownership history.

Title Issued

A state issues a title to provide a vehicle owner with proof of ownership. Each title has a unique number. Each title or registration record on a CARFAX report does not necessarily indicate a change in ownership. In Canada, a registration and bill of sale are used as proof of ownership.

Follow Us:



[facebook.com/CARFAX](https://www.facebook.com/CARFAX)



[@CARFAXinc](https://twitter.com/CARFAXinc)



[About CARFAX](#)

CARFAX DEPENDS ON ITS SOURCES FOR THE ACCURACY AND RELIABILITY OF ITS INFORMATION. THEREFORE, NO RESPONSIBILITY IS ASSUMED BY CARFAX OR ITS AGENTS FOR ERRORS OR OMISSIONS IN THIS REPORT. CARFAX FURTHER EXPRESSLY DISCLAIMS ALL WARRANTIES, EXPRESS OR IMPLIED, INCLUDING ANY IMPLIED WARRANTIES OF MERCHANTABILITY OR FITNESS FOR A PARTICULAR PURPOSE.

© 2025 CARFAX, Inc., part of S&P Global. All rights reserved.
2/28/25 11:07:24 AM (CST)

I have reviewed and received a copy of the CARFAX Vehicle History Report for this 2015 CHEVROLET TAHOE vehicle (VIN: 1GNSK2EC9FR654752), which is based on information supplied to CARFAX and available as of 2/28/25 at 12:07 PM (EST).

Customer Signature

Date

Dealer Signature

Date