



### History-Based Value Report

**\$5,700**

CARFAX Retail Value

#### History events affecting this vehicle's value

- Service History
- Personal Vehicle
- Open Recall
- Minor Damage



### Vehicle History Report™

US \$44.99

**2008 HONDA ACCORD  
EX-L V6**

VIN: 1HGCP36818A078849  
SEDAN 4 DR  
3.5L V6 F SOHC 24V  
GASOLINE  
FRONT WHEEL DRIVE

**Damage reported: minor damage**

MINOR      MODERATE      SEVERE

**34** Service history records

At least 1 open recall

**3** Previous owners

**163,582** Last reported odometer reading



This CARFAX Vehicle History Report is based only on information supplied to CARFAX and available as of 1/15/25 at 7:52:07 PM (CST). Other information about this vehicle, including problems, may not have been reported to CARFAX. Use this report as one important tool, along with a vehicle inspection and test drive, to make a better decision about your next used car.

**CARFAX** Accident / Damage History

Not all accidents / issues are reported to CARFAX

Event 1

04/11/2018

**Damage reported:  
minor damage**

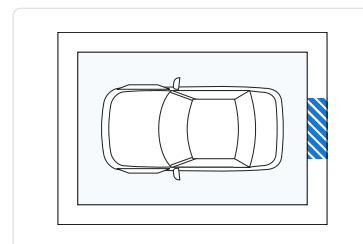
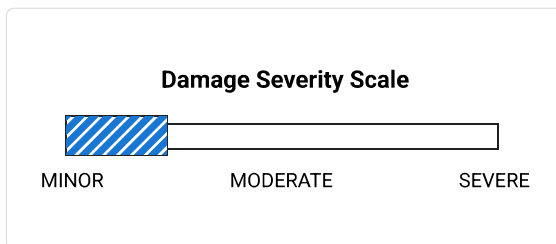

Event 2

09/09/2020

**Damage reported:  
minor damage**

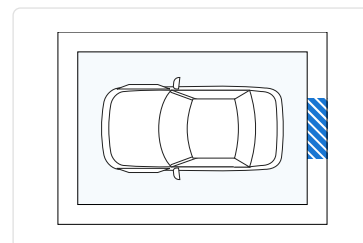
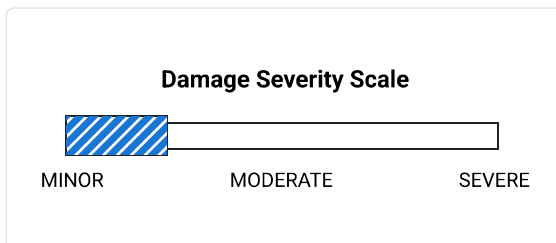

Event 3

07/12/2021

**Accident reported**  
 Vehicle involved in a rear-end collision  
 Involving front impact  
 Vehicle was not damaged  
 Airbags did not deploy

**CARFAX** Additional History

Not all accidents / issues are reported to CARFAX

|                                                        | Owner 1                                                | Owner 2                                                | Owner 3                                                |
|--------------------------------------------------------|--------------------------------------------------------|--------------------------------------------------------|--------------------------------------------------------|
| <b>Total Loss</b><br>No total loss reported to CARFAX. | <input checked="" type="checkbox"/> No Issues Reported | <input checked="" type="checkbox"/> No Issues Reported | <input checked="" type="checkbox"/> No Issues Reported |

|                                                                                                                                                                |                                                         |                                                         |                                                         |
|----------------------------------------------------------------------------------------------------------------------------------------------------------------|---------------------------------------------------------|---------------------------------------------------------|---------------------------------------------------------|
| <b>Structural Damage</b><br>CARFAX recommends that you have this vehicle inspected by a collision repair specialist.                                           | <input checked="" type="checkbox"/> No Issues Reported  | <input checked="" type="checkbox"/> No Issues Reported  | <input checked="" type="checkbox"/> No Issues Reported  |
| <b>Airbag Deployment</b><br>No airbag deployment reported to CARFAX.                                                                                           | <input checked="" type="checkbox"/> No Issues Reported  | <input checked="" type="checkbox"/> No Issues Reported  | <input checked="" type="checkbox"/> No Issues Reported  |
| <b>Odometer Check</b><br>No indication of an odometer rollback.                                                                                                | <input checked="" type="checkbox"/> No Issues Indicated | <input checked="" type="checkbox"/> No Issues Indicated | <input checked="" type="checkbox"/> No Issues Indicated |
| <b>Accident / Damage</b><br>Damage reported: 04/11/2018 and 09/09/2020.<br>Accident reported: 07/12/2021.                                                      | Minor Damage                                            | Minor Damage                                            | No New Issues Reported                                  |
| <b>Manufacturer Recall</b><br>At least 1 manufacturer recall requires service. Locate an authorized Honda dealer to obtain more information about this recall. | Recall Reported                                         | No New Recalls Reported                                 | No New Recalls Reported                                 |
| <b>Basic Warranty</b><br>Original warranty estimated to have expired.                                                                                          | Warranty Expired                                        | Warranty Expired                                        | Warranty Expired                                        |

|  <b>Title History</b><br>CARFAX guarantees the information in this section | Owner 1                                                             | Owner 2                                                             | Owner 3                                                             |
|-------------------------------------------------------------------------------------------------------------------------------------------------------------|---------------------------------------------------------------------|---------------------------------------------------------------------|---------------------------------------------------------------------|
| <b>Damage Brands</b><br>Salvage   Junk   Rebuilt   Fire   Flood   Hail   Lemon                                                                              | <input checked="" type="checkbox"/> <b>Guaranteed</b><br>No Problem | <input checked="" type="checkbox"/> <b>Guaranteed</b><br>No Problem | <input checked="" type="checkbox"/> <b>Guaranteed</b><br>No Problem |
| <b>Odometer Brands</b><br>Not Actual Mileage   Exceeds Mechanical Limits                                                                                    | <input checked="" type="checkbox"/> <b>Guaranteed</b><br>No Problem | <input checked="" type="checkbox"/> <b>Guaranteed</b><br>No Problem | <input checked="" type="checkbox"/> <b>Guaranteed</b><br>No Problem |

**GUARANTEED** - None of these title problems were reported by a U.S. state Department of Motor Vehicles (DMV). If you find that any of these title problems were reported by a DMV and not included in this report, you may qualify.  
[View Terms](#) | [View Certificate](#)

|  <b>Ownership History</b><br>The number of owners is estimated | Owner 1       | Owner 2      | Owner 3  |
|---------------------------------------------------------------------------------------------------------------------------------------------------|---------------|--------------|----------|
| Year purchased                                                                                                                                    | 2008          | 2019         | 2024     |
| Type of owner                                                                                                                                     | Personal      | Personal     | Personal |
| Estimated length of ownership                                                                                                                     | 11 years      | 4 yrs. 6 mo. | 9 months |
| Owned in the following states/provinces                                                                                                           | Massachusetts | Rhode Island | Michigan |
| Estimated miles driven per year                                                                                                                   | 10,572/yr     | 11,521/yr    | ---      |

|                                |         |         |     |
|--------------------------------|---------|---------|-----|
| Last reported odometer reading | 116,697 | 163,582 | --- |
|--------------------------------|---------|---------|-----|

**CARFAX** Detailed History



**Owner 1**  
Purchased: 2008









**Low mileage!** This owner drove less than the industry average of 15,000 miles per year.

Personal Vehicle  
10,572 mi/yr

| Date       | Mileage | Source                                                                                                                        | Comments                                                                                                        |
|------------|---------|-------------------------------------------------------------------------------------------------------------------------------|-----------------------------------------------------------------------------------------------------------------|
| 06/25/2008 | 4       | Boch Honda<br>Norwood, MA<br>781-255-6000<br>bochhonda.com/<br>★ 4.5 / 5.0<br>947 Verified Reviews<br>♥ 23 Customer Favorites | <b>Vehicle serviced</b><br>Pre-delivery inspection completed                                                    |
| 08/24/2008 | 25      | Massachusetts<br>Motor Vehicle Dept.                                                                                          | <b>Vehicle purchase reported</b><br>Titled or registered as personal vehicle                                    |
| 08/25/2008 |         | Boch Honda<br>Norwood, MA<br>781-255-6000<br>bochhonda.com/<br>★ 4.5 / 5.0<br>947 Verified Reviews<br>♥ 23 Customer Favorites | <b>Vehicle serviced</b>                                                                                         |
| 08/27/2008 |         | Massachusetts<br>Motor Vehicle Dept.<br>Hopedale, MA                                                                          | <b>Registration issued or renewed</b><br>Vehicle color noted as Black                                           |
| 08/30/2008 | 33      | Massachusetts<br>Inspection Station<br>Norwood, MA                                                                            | <b>Passed safety inspection</b>                                                                                 |
| 09/12/2008 |         | Massachusetts<br>Motor Vehicle Dept.<br>Hopedale, MA<br>Title #BG098655                                                       | <b>Title issued or updated</b><br>First owner reported<br>Loan or lien reported<br>Vehicle color noted as Black |
| 09/21/2009 | 3,793   | Massachusetts<br>Inspection Station<br>Bellingham, MA                                                                         | <b>Passed safety inspection</b><br>Passed emissions inspection                                                  |

|                                                                                                                                                                                                                                                                                                                                                                                                                                                                                                                                                                                                                                                                                                                                                                                                                                                                                                                                                                  |                                                                |                                                                                                                                                                                                                                                                                                                                                 |
|------------------------------------------------------------------------------------------------------------------------------------------------------------------------------------------------------------------------------------------------------------------------------------------------------------------------------------------------------------------------------------------------------------------------------------------------------------------------------------------------------------------------------------------------------------------------------------------------------------------------------------------------------------------------------------------------------------------------------------------------------------------------------------------------------------------------------------------------------------------------------------------------------------------------------------------------------------------|----------------------------------------------------------------|-------------------------------------------------------------------------------------------------------------------------------------------------------------------------------------------------------------------------------------------------------------------------------------------------------------------------------------------------|
| 12/23/2009                                                                                                                                                                                                                                                                                                                                                                                                                                                                                                                                                                                                                                                                                                                                                                                                                                                                                                                                                       | American Honda Motor Co.                                       | <p><b>Manufacturer Safety-related recall issued</b><br/>                 NHTSA #09E-063<br/>                 Recall #R21 08-2010 ACCORD NOSE MASK<br/>                 Status: Remedy Available</p> <p>Locate an authorized Honda dealer to obtain more information about this recall</p> <p><a href="#">⊖ Learn more about this recall</a></p> |
| <p><b>Description:</b> HONDA IS RECALLING AFTERMARKET FULL NOSE MASKS, PART NUMBER 08P35-TA0-100 AND 08P35-TA6-100 MANUFACTURED BETWEEN AUGUST 9, 2007 THROUGH DECEMBER 11, 2007. THE ACCESSORY WAS DESIGNED SPECIFICALLY FOR MODEL YEAR 2008-2010 HONDA ACCORD 4-DOOR VEHICLES. IT IS POSSIBLE FOR THE NOSE MASK MATERIAL TO INTERFERE WITH PART OF THE HOOD LATCH. IF THE HOOD HAS NOT BEEN COMPLETELY CLOSED AND THE NOSE MASK INTERFERES WITH THE SECONDARY HOOD LATCH MECHANISM THE HOOD MAY POP OPEN WHILE THE VEHICLE BEING DRIVEN.</p> <p>THIS MAY RESULT IN REDUCED DRIVER VISIBILITY THAT COULD INCREASE THE RISK OF A CRASH.</p> <p><b>Remedy:</b> HONDA IS ASKING OWNERS TO PLEASE REMOVE THE NOSE MASK IMMEDIATELY AND CALL ANY AUTHORIZED HONDA DEALER TO MAKE AN APPOINTMENT TO RETURN THE NOSE MASK AND HAVE IT REPLACED FREE OF CHARGE. THE SAFETY RECALL BEGAN ON MARCH 2009. OWNERS MAY CONTACT HONDA CUSTOMER SERVICE AT 1-800-999-1009.</p> |                                                                |                                                                                                                                                                                                                                                                                                                                                 |
| 08/19/2010                                                                                                                                                                                                                                                                                                                                                                                                                                                                                                                                                                                                                                                                                                                                                                                                                                                                                                                                                       | Massachusetts Motor Vehicle Dept. Hopedale, MA Title #BG098655 | <p><b>Registration issued or renewed</b><br/>                 Loan or lien reported<br/>                 Registration updated when owner moved the vehicle to a new location<br/>                 Vehicle color noted as Black</p>                                                                                                              |
| 10/04/2010 7,518                                                                                                                                                                                                                                                                                                                                                                                                                                                                                                                                                                                                                                                                                                                                                                                                                                                                                                                                                 | Massachusetts Inspection Station North Uxbridge, MA            | <p><b>Passed safety inspection</b><br/>                 Passed emissions inspection</p>                                                                                                                                                                                                                                                         |
| 01/02/2012 16,179                                                                                                                                                                                                                                                                                                                                                                                                                                                                                                                                                                                                                                                                                                                                                                                                                                                                                                                                                | Massachusetts Inspection Station North Uxbridge, MA            | <p><b>Passed safety inspection</b><br/>                 Passed emissions inspection</p>                                                                                                                                                                                                                                                         |
| 08/01/2012                                                                                                                                                                                                                                                                                                                                                                                                                                                                                                                                                                                                                                                                                                                                                                                                                                                                                                                                                       | Massachusetts Motor Vehicle Dept. Uxbridge, MA Title #BG098655 | <p><b>Registration issued or renewed</b><br/>                 Vehicle color noted as Black</p>                                                                                                                                                                                                                                                  |

|            |        |                                                                                                                                                          |                                                                                     |                                                                                                               |
|------------|--------|----------------------------------------------------------------------------------------------------------------------------------------------------------|-------------------------------------------------------------------------------------|---------------------------------------------------------------------------------------------------------------|
| 01/27/2013 | 29,201 | Valvoline Instant Oil Change<br>Milford, MA<br>508-966-0910<br>vioc.com<br>★ <b>4.6 / 5.0</b><br>313 Verified Reviews<br>♥ <b>284</b> Customer Favorites |    | <b>Vehicle serviced</b><br>Oil and filter changed                                                             |
| 02/02/2013 | 29,457 | Massachusetts Inspection Station<br>North Uxbridge, MA                                                                                                   |                                                                                     | <b>Passed safety inspection</b><br>Passed emissions inspection                                                |
| 09/13/2013 | 38,979 | Valvoline Instant Oil Change<br>Milford, MA<br>508-966-0910<br>vioc.com<br>★ <b>4.6 / 5.0</b><br>313 Verified Reviews<br>♥ <b>284</b> Customer Favorites |    | <b>Vehicle serviced</b><br>Oil and filter changed<br>Air filter replaced                                      |
| 03/05/2014 | 46,363 | Massachusetts Inspection Station<br>North Uxbridge, MA                                                                                                   |                                                                                     | <b>Passed safety inspection</b><br>Passed emissions inspection                                                |
| 04/19/2014 | 48,528 | Valvoline Instant Oil Change<br>Milford, MA<br>508-966-0910<br>vioc.com<br>★ <b>4.6 / 5.0</b><br>313 Verified Reviews<br>♥ <b>284</b> Customer Favorites |  | <b>Vehicle serviced</b><br>Oil and filter changed                                                             |
| 09/02/2014 |        | Massachusetts Motor Vehicle Dept.<br>Uxbridge, MA<br>Title #BG098655                                                                                     |                                                                                     | <b>Registration issued or renewed</b><br>Vehicle color noted as Black                                         |
| 12/20/2014 | 58,972 | Valvoline Instant Oil Change<br>Milford, MA<br>508-966-0910<br>vioc.com<br>★ <b>4.6 / 5.0</b><br>313 Verified Reviews<br>♥ <b>284</b> Customer Favorites |  | <b>Vehicle serviced</b><br>Oil and filter changed<br>Wiper(s) replaced<br>Front wiper blades/refills replaced |

|            |        |                                                                                                                                                                 |                                                                                     |                                                                       |
|------------|--------|-----------------------------------------------------------------------------------------------------------------------------------------------------------------|-------------------------------------------------------------------------------------|-----------------------------------------------------------------------|
| 04/06/2015 | 62,935 | Massachusetts<br>Inspection Station<br>North Uxbridge, MA                                                                                                       |                                                                                     | <b>Passed safety inspection</b><br>Passed emissions inspection        |
| 07/30/2015 | 66,711 | Valvoline Instant Oil<br>Change<br>Milford, MA<br>508-966-0910<br>vioc.com<br>★ <b>4.6 / 5.0</b><br>313 Verified Reviews<br>❤️ <b>284</b> Customer Favorites    |    | <b>Vehicle serviced</b><br>Oil and filter changed                     |
| 05/06/2016 | 75,457 | Massachusetts<br>Inspection Station<br>North Grafton, MA                                                                                                        |                                                                                     | <b>Failed safety inspection</b><br>Passed emissions inspection        |
| 05/31/2016 | 76,224 | Massachusetts<br>Inspection Station<br>North Grafton, MA                                                                                                        |                                                                                     | <b>Passed safety inspection</b><br>Passed emissions inspection        |
| 08/01/2016 |        | Massachusetts<br>Motor Vehicle Dept.<br>Uxbridge, MA<br>Title #BG098655                                                                                         |                                                                                     | <b>Registration issued or renewed</b><br>Vehicle color noted as Black |
| 10/29/2016 | 81,428 | Valvoline Instant Oil<br>Change<br>Milford, MA<br>508-966-0910<br>vioc.com<br>★ <b>4.6 / 5.0</b><br>313 Verified Reviews<br>❤️ <b>284</b> Customer Favorites    |  | <b>Vehicle serviced</b><br>Oil and filter changed                     |
| 06/03/2017 | 89,191 | Massachusetts<br>Inspection Station<br>North Uxbridge, MA                                                                                                       |                                                                                     | <b>Passed safety inspection</b><br>Passed emissions inspection        |
| 06/22/2017 | 90,000 | Valvoline Instant Oil<br>Change<br>Shrewsbury, MA<br>508-842-9500<br>vioc.com<br>★ <b>4.6 / 5.0</b><br>148 Verified Reviews<br>❤️ <b>174</b> Customer Favorites |  | <b>Vehicle serviced</b><br>Oil and filter changed                     |

03/24/2018 100,000

Valvoline Instant Oil Change  
Milford, MA  
508-966-0910  
vioc.com



**Vehicle serviced**  
Oil and filter changed

★ 4.6 / 5.0

313 Verified Reviews

♥ 284 Customer Favorites

04/11/2018

Damage Report



**Damage reported: minor damage**  
Damage to rear



**CARFAX HAS THE MOST ACCIDENT & DAMAGE INFORMATION**

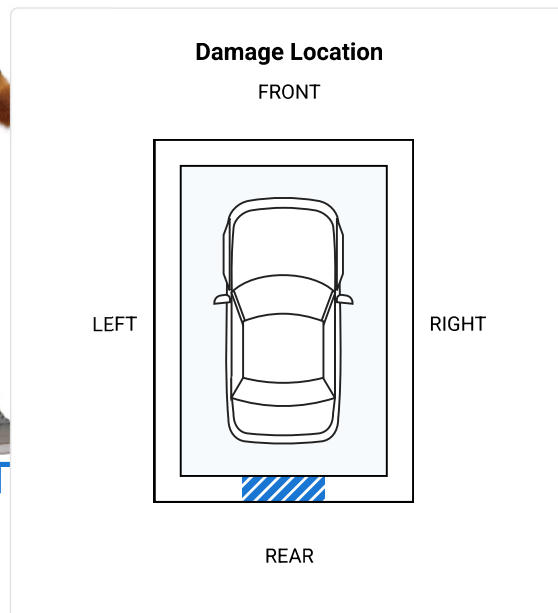
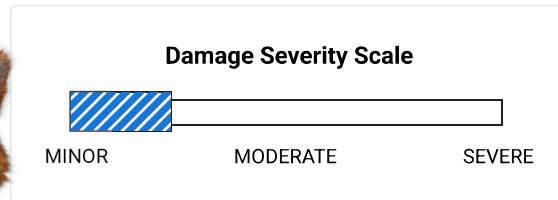

Minor damage is usually cosmetic, including dents or scratches to the vehicle body.

07/07/2018 103,200

Massachusetts Inspection Station  
North Uxbridge, MA

**Failed safety inspection**  
Passed emissions inspection



07/28/2018 103,781



Massachusetts Inspection Station  
North Uxbridge, MA







**Passed safety inspection**



|            |         |                                                                                                                                                                 |                                                                                   |                                                                          |
|------------|---------|-----------------------------------------------------------------------------------------------------------------------------------------------------------------|-----------------------------------------------------------------------------------|--------------------------------------------------------------------------|
| 08/01/2018 |         | Massachusetts<br>Motor Vehicle Dept.<br>Uxbridge, MA<br>Title #BG098655                                                                                         |                                                                                   | <b>Registration issued or renewed</b><br>Vehicle color noted as Black    |
| 12/10/2018 | 108,217 | Valvoline Instant Oil<br>Change<br>Shrewsbury, MA<br>508-842-9500<br>vioc.com<br>★ <b>4.6 / 5.0</b><br>148 Verified Reviews<br>❤️ <b>174</b> Customer Favorites |  | <b>Vehicle serviced</b><br>Oil and filter changed<br>Air filter replaced |
| 08/08/2019 | 115,751 | Massachusetts<br>Inspection Station<br>North Uxbridge, MA                                                                                                       |                                                                                   | <b>Passed safety inspection</b><br>Passed emissions inspection           |
| 09/04/2019 | 116,697 | Dealer Inventory                                                                                                                                                |                                                                                   | <b>Vehicle offered for sale</b>                                          |

|                                                                                                                     |                                                                                   |                                                                                               |                                  |
|---------------------------------------------------------------------------------------------------------------------|-----------------------------------------------------------------------------------|-----------------------------------------------------------------------------------------------|----------------------------------|
|  <b>Owner 2</b><br>Purchased: 2019 |  | <b>Low mileage!</b> This owner drove less than the industry average of 15,000 miles per year. | Personal Vehicle<br>11,521 mi/yr |
|---------------------------------------------------------------------------------------------------------------------|-----------------------------------------------------------------------------------|-----------------------------------------------------------------------------------------------|----------------------------------|

| Date       | Mileage | Source                                                                                                                                                       |                                                                                     | Comments                                                                                                                  |
|------------|---------|--------------------------------------------------------------------------------------------------------------------------------------------------------------|-------------------------------------------------------------------------------------|---------------------------------------------------------------------------------------------------------------------------|
| 09/20/2019 | 116,926 | Rhode Island<br>Motor Vehicle Dept.<br>Barrington, RI<br>Title #20451142                                                                                     |                                                                                     | <b>Title issued or updated</b><br>Registration issued or renewed<br>New owner reported<br>Vehicle color noted as Black    |
| 12/19/2019 | 121,162 | Valvoline Instant Oil<br>Change<br>Seekonk, MA<br>508-336-6336<br>vioc.com<br>★ <b>4.4 / 5.0</b><br>227 Verified Reviews<br>❤️ <b>283</b> Customer Favorites |  | <b>Vehicle serviced</b><br>License plate light bulb(s) replaced<br>Brake light bulb(s) replaced<br>Oil and filter changed |
| 01/03/2020 | 121,952 | Valvoline Instant Oil<br>Change<br>Seekonk, MA<br>508-336-6336<br>vioc.com<br>★ <b>4.4 / 5.0</b><br>227 Verified Reviews<br>❤️ <b>283</b> Customer Favorites |  | <b>Vehicle serviced</b><br>Cabin air filter replaced/cleaned                                                              |

|            |         |                                                                                                                                                              |                                                                                     |                                                                                              |
|------------|---------|--------------------------------------------------------------------------------------------------------------------------------------------------------------|-------------------------------------------------------------------------------------|----------------------------------------------------------------------------------------------|
| 01/16/2020 | 122,335 | Barrington Automotive<br>Barrington, RI<br>641-295-0018<br>★ <b>5.0 / 5.0</b><br>43 Verified Reviews<br>❤️ <b>16</b> Customer Favorites                      |    | <b>Vehicle serviced</b><br>Antifreeze/coolant checked<br>Radiator replaced<br>Fluids checked |
| 04/01/2020 | 126,102 | Valvoline Instant Oil<br>Change<br>Seekonk, MA<br>508-336-6336<br>vioc.com<br>★ <b>4.4 / 5.0</b><br>227 Verified Reviews<br>❤️ <b>283</b> Customer Favorites |    | <b>Vehicle serviced</b><br>Maintenance inspection completed                                  |
| 04/13/2020 | 126,601 | Valvoline Instant Oil<br>Change<br>Seekonk, MA<br>508-336-6336<br>vioc.com<br>★ <b>4.4 / 5.0</b><br>227 Verified Reviews<br>❤️ <b>283</b> Customer Favorites |    | <b>Vehicle serviced</b><br>Oil and filter changed                                            |
| 06/30/2020 | 129,201 | Valvoline Instant Oil<br>Change<br>Seekonk, MA<br>508-336-6336<br>vioc.com<br>★ <b>4.4 / 5.0</b><br>227 Verified Reviews<br>❤️ <b>283</b> Customer Favorites |  | <b>Vehicle serviced</b><br>Maintenance inspection completed                                  |
| 08/22/2020 | 130,702 | Valvoline Instant Oil<br>Change<br>Seekonk, MA<br>508-336-6336<br>vioc.com<br>★ <b>4.4 / 5.0</b><br>227 Verified Reviews<br>❤️ <b>283</b> Customer Favorites |  | <b>Vehicle serviced</b><br>Oil and filter changed<br>Air filter replaced                     |
| 08/30/2020 |         | Rhode Island<br>Motor Vehicle Dept.<br>Barrington, RI                                                                                                        |                                                                                     | <b>Registration issued or renewed</b><br>Vehicle color noted as Black                        |
| 09/09/2020 |         | Damage Report                                                                                                                                                |  | <b>Damage reported: minor damage</b><br>Damage to rear                                       |



**CARFAX HAS THE MOST ACCIDENT & DAMAGE INFORMATION**

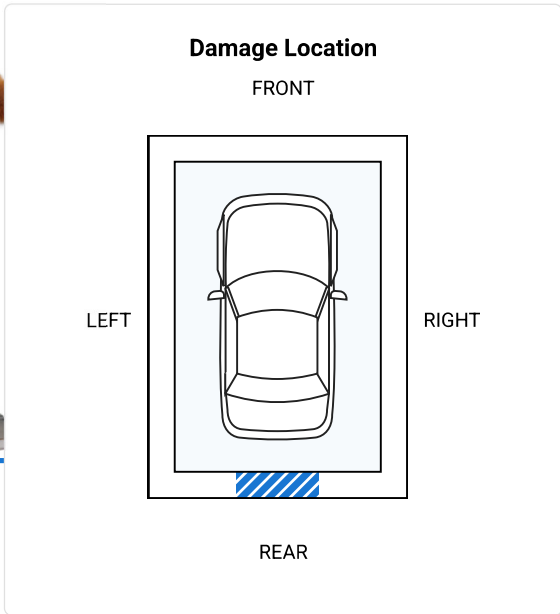
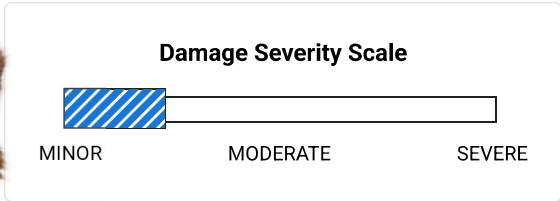

Minor damage is usually cosmetic, including dents or scratches to the vehicle body.

11/08/2020 133,756 Valvoline Instant Oil Change  
 Seekonk, MA  
 508-336-6336  
 vioc.com  
 ★ 4.4 / 5.0  
 227 Verified Reviews  
 ❤️ 283 Customer Favorites













**Vehicle serviced**  
 Maintenance inspection completed





12/07/2020 134,507 Valvoline Instant Oil Change  
 Seekonk, MA  
 508-336-6336  
 vioc.com  
 ★ 4.4 / 5.0  
 227 Verified Reviews  
 ❤️ 283 Customer Favorites



**Vehicle serviced**  
 Maintenance inspection completed

|            |               |                                                                                                                                                                                       |                                                                                                                                                                |                                                                                                                                                                                                                                                                                                 |
|------------|---------------|---------------------------------------------------------------------------------------------------------------------------------------------------------------------------------------|----------------------------------------------------------------------------------------------------------------------------------------------------------------|-------------------------------------------------------------------------------------------------------------------------------------------------------------------------------------------------------------------------------------------------------------------------------------------------|
| 01/13/2021 | 135,167       | <p>Valvoline Instant Oil Change<br/>Seekonk, MA<br/>508-336-6336<br/>vioc.com</p> <p>★ <b>4.4 / 5.0</b><br/>227 Verified Reviews<br/>♥ <b>283</b> Customer Favorites</p>              |                                                                               | <p><b>Vehicle serviced</b><br/>Maintenance inspection completed</p>                                                                                                                                                                                                                             |
| 04/13/2021 | 138,029       | <p>Melvin's Tire Pros &amp; Auto Center<br/>Seekonk, MA<br/>508-336-4100<br/>tireprosri.com</p> <p>★ <b>4.9 / 5.0</b><br/>129 Verified Reviews<br/>♥ <b>40</b> Customer Favorites</p> |                                                                               | <p><b>Vehicle serviced</b><br/>Brake caliper(s) replaced<br/>Rear brake caliper(s) replaced<br/>Oil and filter changed<br/>Steering/suspension checked<br/>Power steering fluid flushed/changed<br/>Front brake pads replaced<br/>Rear brake pads replaced<br/>Rear brake rotor(s) replaced</p> |
| 07/12/2021 | Damage Report |                                                                                                      | <p><b>Accident reported</b><br/>Vehicle involved in a rear-end collision<br/>Involving front impact<br/>Vehicle was not damaged<br/>Airbags did not deploy</p> |                                                                                                                                                                                                                                                                                                 |
| 09/16/2021 | 142,810       | <p>Melvin's Tire Pros &amp; Auto Center<br/>Seekonk, MA<br/>508-336-4100<br/>tireprosri.com</p> <p>★ <b>4.9 / 5.0</b><br/>129 Verified Reviews<br/>♥ <b>40</b> Customer Favorites</p> |                                                                             | <p><b>Vehicle serviced</b><br/>Drive belts checked<br/>Alternator checked</p>                                                                                                                                                                                                                   |
| 09/29/2021 | 143,084       | <p>Melvin's Tire Pros - Johnston<br/>Johnston, RI<br/>401-934-3220<br/>tireprosri.com/</p> <p>★ <b>4.9 / 5.0</b><br/>117 Verified Reviews<br/>♥ <b>62</b> Customer Favorites</p>      |                                                                             | <p><b>Vehicle serviced</b><br/>Emissions or safety inspection performed</p>                                                                                                                                                                                                                     |

|            |         |                                                                                                                                                                   |                                                                                     |                                                                       |
|------------|---------|-------------------------------------------------------------------------------------------------------------------------------------------------------------------|-------------------------------------------------------------------------------------|-----------------------------------------------------------------------|
| 10/11/2021 | 143,613 | Valvoline Instant Oil Change<br>Seekonk, MA<br>508-336-6336<br>vioc.com<br>★ <b>4.4 / 5.0</b><br>227 Verified Reviews<br>♥ <b>283</b> Customer Favorites          |    | <b>Vehicle serviced</b><br>Oil and filter changed                     |
| 11/11/2021 | 144,201 | Melvin's Tire Pros & Auto Center<br>Seekonk, MA<br>508-336-4100<br>tireprosri.com<br>★ <b>4.9 / 5.0</b><br>129 Verified Reviews<br>♥ <b>40</b> Customer Favorites |    | <b>Vehicle serviced</b>                                               |
| 03/02/2022 | 149,033 | Valvoline Instant Oil Change<br>Seekonk, MA<br>508-336-6336<br>vioc.com<br>★ <b>4.4 / 5.0</b><br>227 Verified Reviews<br>♥ <b>283</b> Customer Favorites          |    | <b>Vehicle serviced</b><br>Oil and filter changed                     |
| 07/20/2022 | 152,134 | Melvin's Tire Pros & Auto Center<br>Seekonk, MA<br>508-336-4100<br>tireprosri.com<br>★ <b>4.9 / 5.0</b><br>129 Verified Reviews<br>♥ <b>40</b> Customer Favorites |  | <b>Vehicle serviced</b>                                               |
| 08/26/2022 |         | Rhode Island Motor Vehicle Dept.<br>Barrington, RI                                                                                                                |                                                                                     | <b>Registration issued or renewed</b><br>Vehicle color noted as Black |
| 11/25/2022 | 154,640 | Valvoline Instant Oil Change<br>Warwick, RI<br>401-738-9935<br>vioc.com<br>★ <b>4.5 / 5.0</b><br>219 Verified Reviews<br>♥ <b>215</b> Customer Favorites          |  | <b>Vehicle serviced</b><br>Oil and filter changed                     |

|            |         |                                                                                                                                   |                                                                                     |                                                                                                                                     |
|------------|---------|-----------------------------------------------------------------------------------------------------------------------------------|-------------------------------------------------------------------------------------|-------------------------------------------------------------------------------------------------------------------------------------|
| 03/15/2023 | 157,940 | New England Tire<br>Seekonk, MA<br>508-336-2170<br>★ <b>4.9 / 5.0</b><br>109 Verified Reviews<br>❤️ <b>126</b> Customer Favorites |    | <b>Vehicle serviced</b><br>Exhaust repaired                                                                                         |
| 06/03/2023 | 160,296 | New England Tire<br>Seekonk, MA<br>508-336-2170<br>★ <b>4.9 / 5.0</b><br>109 Verified Reviews<br>❤️ <b>126</b> Customer Favorites |    | <b>Vehicle serviced</b>                                                                                                             |
| 06/26/2023 | 160,978 | New England Tire<br>Seekonk, MA<br>508-336-2170<br>★ <b>4.9 / 5.0</b><br>109 Verified Reviews<br>❤️ <b>126</b> Customer Favorites |    | <b>Vehicle serviced</b><br>Tires rotated<br>Oil and filter changed                                                                  |
| 08/26/2023 | 162,606 | New England Tire<br>Seekonk, MA<br>508-336-2170<br>★ <b>4.9 / 5.0</b><br>109 Verified Reviews<br>❤️ <b>126</b> Customer Favorites |    | <b>Vehicle serviced</b><br>Brakes serviced<br>Front brake pads replaced<br>Rear brake pads replaced<br>Rear brake rotor(s) replaced |
| 10/07/2023 | 163,582 | New England Tire<br>Seekonk, MA<br>508-336-2170<br>★ <b>4.9 / 5.0</b><br>109 Verified Reviews<br>❤️ <b>126</b> Customer Favorites |  | <b>Vehicle serviced</b><br>Emissions or safety inspection performed                                                                 |

 **Owner 3** Personal Vehicle  
Purchased: 2024

| Date       | Mileage | Source                                                                  | Comments                                                                               |
|------------|---------|-------------------------------------------------------------------------|----------------------------------------------------------------------------------------|
| 04/15/2024 |         | Michigan<br>Motor Vehicle Dept.                                         | <b>Vehicle purchase reported</b>                                                       |
| 01/09/2025 |         | Michigan<br>Motor Vehicle Dept.<br>Kalamazoo, MI<br>Title #MI0024169361 | <b>Title issued or updated</b><br>New owner reported<br>Exempt from odometer reporting |

Have Questions? Consumers, please visit our Help Center at [www.carfax.com](http://www.carfax.com). Dealers or Subscribers, please visit our Help Center at [www.carfaxonline.com](http://www.carfaxonline.com).



## Glossary

### Accident Indicator

CARFAX receives information about accidents in all 50 states, the District of Columbia and Canada.

Not every accident is reported to CARFAX. As details about the accident become available, those additional details are added to the CARFAX Vehicle History Report. CARFAX recommends that you have this vehicle inspected by a qualified mechanic.

- According to the National Safety Council, Injury Facts, 2021 edition, 5% of the 276 million registered vehicles in the U.S. were involved in an accident in 2019. Over 77% of these were considered minor or moderate.
- This CARFAX Vehicle History Report is based only on information supplied to CARFAX and available as of 1/15/25 at 7:52:07 PM (CST). Other information about this vehicle, including problems, may not have been reported to CARFAX. Use this report as one important tool, along with a vehicle inspection and test drive, to make a better decision about your next used car.

### Damage Indicator

Damage can be a result of many different types of events. Examples include contact with objects (other cars, trees, traffic signs, road debris, etc), vandalism, or weather-related events. Not every damage event is reported to CARFAX. As details about the damage event become available, those additional details are added to the CARFAX Vehicle History Report. CARFAX recommends that you have this vehicle inspected by a qualified mechanic.

- This CARFAX Vehicle History Report is based only on information supplied to CARFAX and available as of 1/15/25 at 7:52:07 PM (CST). Other information about this vehicle, including problems, may not have been reported to CARFAX. Use this report as one important tool, along with a vehicle inspection and test drive, to make a better decision about your next used car.

### Damage Severity

Damage events result in one of the following severity levels:

- Minor: Generally, minor damage is cosmetic (including dents or scratches), may only require reconditioning, and typically does not compromise a vehicle's operation and/or safety.
- Moderate: Moderate damage may affect multiple components of the vehicle and may impair the vehicle's operation and/or safety.
- Severe: Severe damage usually affects multiple components of the vehicle and is likely to compromise the vehicle's operation and/or safety.

CARFAX recommends getting a pre-purchase inspection at a certified collision repair facility.

### First Owner

When the first owner(s) obtains a title from a Department of Motor Vehicles as proof of ownership.

### Inspections

Many states or counties require annual or biennial emissions and/or safety inspections. Odometer readings are collected at the time of the inspection.

### Manufacturer Recall

Automobile manufacturers issue recall notices to inform vehicle owners of a safety defect or failure to meet minimum federal safety or emissions standards. Manufacturer recalls are repaired at no cost to the customer.

### New Owner Reported

When a vehicle is sold to a new owner, the Title must be transferred to the new owner(s) at a Department of Motor Vehicles.



### Ownership History

CARFAX defines an owner as an individual or business that possesses and uses a vehicle. Not all title

transactions represent changes in ownership. To provide estimated number of owners, CARFAX proprietary technology analyzes all the events in a vehicle history. Estimated ownership is available for vehicles manufactured after 1991 and titled solely in the US including Puerto Rico. Dealers sometimes opt to take ownership of a vehicle and are required to in the following states: Maine, Massachusetts, New Jersey, Ohio, Oklahoma, Pennsylvania and South Dakota. Please consider this as you review a vehicle's estimated ownership history.

**Title Issued**

A state issues a title to provide a vehicle owner with proof of ownership. Each title has a unique number. Each title or registration record on a CARFAX report does not necessarily indicate a change in ownership. In Canada, a registration and bill of sale are used as proof of ownership.

**Follow Us:**  [facebook.com/CARFAX](https://facebook.com/CARFAX)  [@CARFAXinc](https://twitter.com/CARFAXinc)  [About CARFAX](#)

CARFAX DEPENDS ON ITS SOURCES FOR THE ACCURACY AND RELIABILITY OF ITS INFORMATION. THEREFORE, NO RESPONSIBILITY IS ASSUMED BY CARFAX OR ITS AGENTS FOR ERRORS OR OMISSIONS IN THIS REPORT. CARFAX FURTHER EXPRESSLY DISCLAIMS ALL WARRANTIES, EXPRESS OR IMPLIED, INCLUDING ANY IMPLIED WARRANTIES OF MERCHANTABILITY OR FITNESS FOR A PARTICULAR PURPOSE.

© 2025 CARFAX, Inc., part of S&P Global. All rights reserved.  
1/15/25 7:52:07 PM (CST)

**I have reviewed and received a copy of the CARFAX Vehicle History Report for this 2008 HONDA ACCORD vehicle (VIN: 1HGCP36818A078849), which is based on information supplied to CARFAX and available as of 1/15/25 at 8:52 PM (EST).**

|                           |  |             |  |                         |  |             |
|---------------------------|--|-------------|--|-------------------------|--|-------------|
| <b>Customer Signature</b> |  | <b>Date</b> |  | <b>Dealer Signature</b> |  | <b>Date</b> |
|---------------------------|--|-------------|--|-------------------------|--|-------------|