



Vehicle History Report™

US \$44.99

2004 CADILLAC SRX

VIN: 1GYDE63A040100190
4 DOOR WAGON/SPORT
UTILITY
4.6L V8 F
GASOLINE

Accident reported: minor damage

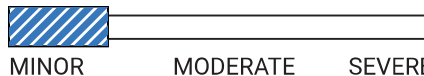

55 Service history records



5 Previous owners



Types of owners: Corporate fleet, Lease, Personal



178,595 Last reported odometer reading



This CARFAX Vehicle History Report is based only on information supplied to CARFAX and available as of 8/31/24 at 6:49:02 AM (CDT). Other information about this vehicle, including problems, may not have been reported to CARFAX. Use this report as one important tool, along with a vehicle inspection and test drive, to make a better decision about your next used car.



Accident / Damage History

Not all accidents / issues are reported to CARFAX

Event 1

09/30/2008

**Accident reported:
very minor damage
with another motor
vehicle**

Damage Severity Scale

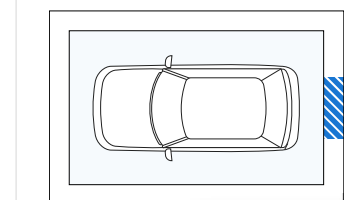
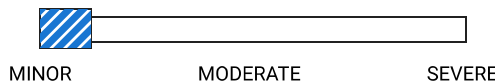

[^ Back To Top](#)

Event 2

01/31/2011

**Accident reported:
very minor damage**

It hit a parked motor vehicle

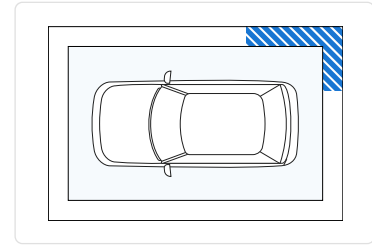
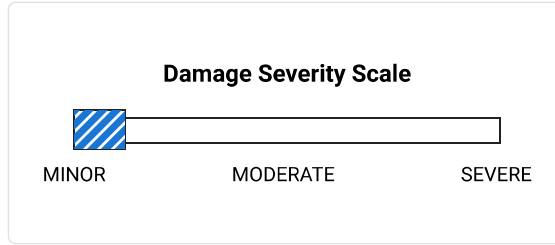



Event 3

01/27/2019

**Accident reported:
minor damage**

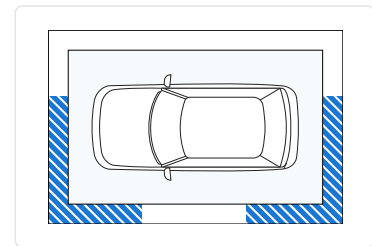
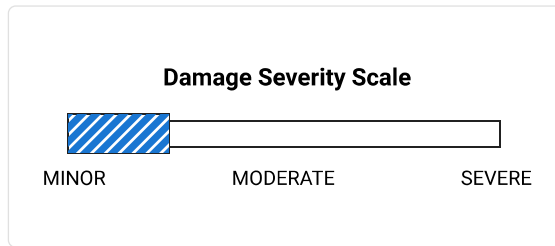
Involving multiple impact areas
It hit a ditch
Functional damage reported



 Additional History Not all accidents / issues are reported to CARFAX	Owners 1-3	Owner 4	Owner 5
Total Loss No total loss reported to CARFAX.	<input checked="" type="checkbox"/> No Issues Reported	<input checked="" type="checkbox"/> No Issues Reported	<input checked="" type="checkbox"/> No Issues Reported
Structural Damage CARFAX recommends that you have this vehicle inspected by a collision repair specialist.	<input checked="" type="checkbox"/> No Issues Reported	<input checked="" type="checkbox"/> No Issues Reported	<input checked="" type="checkbox"/> No Issues Reported
Airbag Deployment No airbag deployment reported to CARFAX.	<input checked="" type="checkbox"/> No Issues Reported	<input checked="" type="checkbox"/> No Issues Reported	<input checked="" type="checkbox"/> No Issues Reported
Odometer Check No indication of an odometer rollback.	<input checked="" type="checkbox"/> No Issues Indicated	<input checked="" type="checkbox"/> No Issues Indicated	<input checked="" type="checkbox"/> No Issues Indicated
Accident / Damage Accidents reported: 09/30/2008, 01/31/2011, and 01/27/2019.	<input checked="" type="checkbox"/> No Issues Reported	<input checked="" type="checkbox"/> No Issues Reported	Minor Damage
Manufacturer Recall No open recalls reported to CARFAX. Check for open recalls on GM vehicles at recalls.gm.com.	<input checked="" type="checkbox"/> No Recalls Reported	<input checked="" type="checkbox"/> No Recalls Reported	<input checked="" type="checkbox"/> No Recalls Reported

[^ Back To Top](#)

Basic Warranty Original warranty estimated to have expired.	Warranty Expired	Warranty Expired	Warranty Expired
---	-------------------------	-------------------------	-------------------------

CARFAX Title History CARFAX guarantees the information in this section	Owners 1-3	Owner 4	Owner 5
Damage Brands Salvage Junk Rebuilt Fire Flood Hail Lemon	<input checked="" type="checkbox"/> Guaranteed No Problem	<input checked="" type="checkbox"/> Guaranteed No Problem	<input checked="" type="checkbox"/> Guaranteed No Problem
Odometer Brands Not Actual Mileage Exceeds Mechanical Limits	<input checked="" type="checkbox"/> Guaranteed No Problem	<input checked="" type="checkbox"/> Guaranteed No Problem	<input checked="" type="checkbox"/> Guaranteed No Problem



GUARANTEED - None of these title problems were reported by a U.S. state Department of Motor Vehicles (DMV). If you find that any of these title problems were reported by a DMV and not included in this report, you may qualify. [View Terms](#) | [View Certificate](#)

CARFAX Ownership History The number of owners is estimated	Owners 1-3	Owner 4	Owner 5
Year purchased	2003	2006	2008
Type of owner	See Details	Personal	Personal
Estimated length of ownership	3 years	2 yrs. 1 mo.	16 yrs. 1 mo.
Owned in the following states/provinces	See Details	Michigan	Michigan
Estimated miles driven per year	---	---	13,481/yr
Last reported odometer reading	30,006	54,879	178,595

CARFAX Detailed History



Owner 1
Purchased: 2003

Corporate Fleet Vehicle

Date	Mileage	Source	Comments
05/21/2003		Michigan Motor Vehicle Dept. Warren, MI Title #801P1410097	Title or registration issued First owner reported Titled or registered as corporate fleet vehicle
07/20/2004		Dealer Inventory Michigan	Vehicle sold

[^ Back To Top](#)



Owner 2

Purchased: 2004

Lease Vehicle



Date	Mileage	Source	Comments
07/22/2004	11,460	Michigan Motor Vehicle Dept. Swartz Creek, MI Title #209R2040103	Title or registration issued New owner reported Titled or registered as lease vehicle
12/06/2004	16,151	Service Facility	 Vehicle serviced Maintenance inspection completed Timing belt replaced Fuel filler cap replaced Fuel filler cap gasket replaced ABS/TCS module reprogrammed



Owner 3

Purchased: 2005

Lease Vehicle

Date	Mileage	Source	Comments
08/03/2005		Michigan Motor Vehicle Dept. Swartz Creek, MI Title #209R2040103	Title or registration issued New owner reported Titled or registered as lease vehicle
08/12/2005		Service Facility ★ 4.4 / 5.0 225 Verified Reviews	 Vehicle serviced
11/15/2005		Service Facility ★ 4.4 / 5.0 225 Verified Reviews	 Vehicle serviced
06/01/2006	29,790	Inspection Report Michigan	Post-lease inspection performed Overall condition reported as excellent Black exterior Tan interior
06/07/2006		Auto Auction	Vehicle sold



Millions of used vehicles are bought and sold at auction every year.

[^ Back To Top](#)



06/09/2006 Dave Kring Chevrolet Petoskey, MI 231-347-2585 davekring.com
 ★ 4.8 / 5.0
 242 Verified Reviews
 ❤️ 18 Customer Favorites

 **Vehicle serviced**
 Vehicle washed/detailed



06/16/2006 30,006 Dave Kring Chevrolet Petoskey, MI 231-347-2585 davekring.com
 ★ 4.8 / 5.0
 242 Verified Reviews
 ❤️ 18 Customer Favorites

Vehicle sold

 **Owner 4** Personal Vehicle
 Purchased: 2006

Date	Mileage	Source	Comments
06/20/2006		Michigan Motor Vehicle Dept. Harbor Springs, MI Title #371T1710144	Title or registration issued New owner reported
06/22/2006		Dave Kring Chevrolet Petoskey, MI 231-347-2585 davekring.com ★ 4.8 / 5.0 242 Verified Reviews ❤️ 18 Customer Favorites	 Vehicle serviced Pre-delivery inspection completed Maintenance inspection completed Tire(s) replaced Four tires replaced Oil and filter changed Engine/powertrain computer/module reprogrammed
12/22/2006		Dave Kring Chevrolet Petoskey, MI 231-347-2585 davekring.com ★ 4.8 / 5.0 242 Verified Reviews ❤️ 18 Customer Favorites	 Vehicle serviced Oil and filter changed Interior roof console replaced Battery replaced
07/19/2007		Michigan Motor Vehicle Dept. Harbor Springs, MI	Registration issued or renewed

[^ Back To Top](#)

09/17/2007	Dave Kring Chevrolet Petoskey, MI 231-347-2585 davekring.com ★ 4.8 / 5.0 242 Verified Reviews ♥ 18 Customer Favorites	 Vehicle serviced Oil and filter changed
10/16/2007	Dave Kring Chevrolet Petoskey, MI 231-347-2585 davekring.com ★ 4.8 / 5.0 242 Verified Reviews ♥ 18 Customer Favorites	 Vehicle serviced
01/17/2008 54,879	Dave Kring Chevrolet Petoskey, MI 231-347-2585 davekring.com ★ 4.8 / 5.0 242 Verified Reviews ♥ 18 Customer Favorites	 Vehicle serviced Wiper(s) replaced
06/26/2008	Michigan Motor Vehicle Dept. Harbor Springs, MI	Registration issued or renewed



Owner 5
Purchased: 2008



Low mileage! This owner drove less than the industry average of 15,000 miles per year.

Personal Vehicle
13,481 mi/yr

Date	Mileage	Source	Comments
07/29/2008		Michigan Motor Vehicle Dept. Cheboygan, MI Title #371W2110196	Title or registration issued New owner reported
08/08/2008 59,958		Bishop GMC Cadillac Cheboygan, MI 231-627-5669 bishopgmc Cadillac.com/ vehiclesearchresults? search=preowned ★ 4.8 / 5.0 170 Verified Reviews ♥ 404 Customer Favorites	 Vehicle serviced Body electrical system checked

^ Back To Top

09/29/2008 61,820

Lahaie's Auto Service Center
Cheboygan, MI
231-627-3381



Vehicle serviced
Oil and filter changed

09/30/2008

Damage Report



Accident reported: very minor damage with another motor vehicle
Damage to rear



CARFAX HAS THE MOST ACCIDENT & DAMAGE INFORMATION

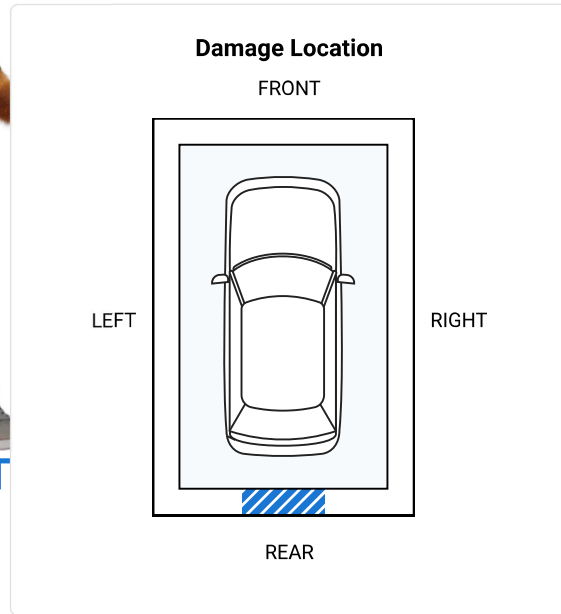
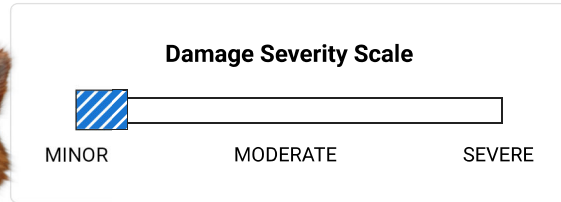

Minor damage is usually cosmetic, including dents or scratches to the vehicle body.

11/05/2008

Jim Wernig Chevrolet
Gaylord, MI
989-732-5161
chevycentral.com



Vehicle serviced

★ **4.7 / 5.0**
100 Verified Reviews
❤️ **20** Customer Favorites





12/10/2008 65,420

Lahaie's Auto Service Center
Cheboygan, MI
231-627-3381









Vehicle serviced
Oil and filter changed





^ **Back To Top**

12/30/2008	66,139	Dave Kring Chevrolet Petoskey, MI 231-347-2585 davekring.com ★ 4.8 / 5.0 242 Verified Reviews ♥ 18 Customer Favorites		Vehicle serviced
01/13/2009	66,466	Dave Kring Chevrolet Petoskey, MI 231-347-2585 davekring.com ★ 4.8 / 5.0 242 Verified Reviews ♥ 18 Customer Favorites		Vehicle serviced
01/22/2009	66,932	Bishop GMC Cadillac Cheboygan, MI 231-627-5669 bishopgmccadillac.com/ vehiclesearchresults? search=preowned ★ 4.8 / 5.0 170 Verified Reviews ♥ 404 Customer Favorites		Vehicle serviced Drivability/performance checked
02/27/2009		Michigan Motor Vehicle Dept. Cheboygan, MI		Registration issued or renewed
04/09/2009	69,894	Big Jake's Quick Lube Cheboygan, MI 231-627-5685		Vehicle serviced Oil and filter changed
07/20/2009	73,388	Bishop GMC Cadillac Cheboygan, MI 231-627-5669 bishopgmccadillac.com/ vehiclesearchresults? search=preowned ★ 4.8 / 5.0 170 Verified Reviews ♥ 404 Customer Favorites		Vehicle serviced Oil and filter changed

[^ Back To Top](#)

10/12/2009	76,362	Bishop GMC Cadillac Cheboygan, MI 231-627-5669 bishopgmccadillac.com/ vehiclesearchresults? search=preowned ★ 4.8 / 5.0 170 Verified Reviews ♥ 404 Customer Favorites		Vehicle serviced Exterior lights checked
12/02/2009	78,350	Lahaie's Auto Service Center Cheboygan, MI 231-627-3381		Vehicle serviced Fluids checked Oil and filter changed Body lubricated
02/16/2010	81,475	Lahaie's Auto Service Center Cheboygan, MI 231-627-3381		Vehicle serviced Fluids checked Oil and filter changed Body lubricated
02/23/2010	82,233	Dave Kring Chevrolet Petoskey, MI 231-347-2585 davekring.com ★ 4.8 / 5.0 242 Verified Reviews ♥ 18 Customer Favorites		Vehicle serviced Maintenance inspection completed
02/27/2010		Michigan Motor Vehicle Dept. Cheboygan, MI		Registration issued or renewed
04/01/2010	83,784	Bishop GMC Cadillac Cheboygan, MI 231-627-5669 bishopgmccadillac.com/ vehiclesearchresults? search=preowned ★ 4.8 / 5.0 170 Verified Reviews ♥ 404 Customer Favorites		Vehicle serviced Body electrical system checked
04/09/2010	83,827	Lahaie's Auto Service Center Cheboygan, MI 231-627-3381		Vehicle serviced Battery/charging system checked Battery replaced

[^ Back To Top](#)

05/20/2010	85,400	Lahaie's Auto Service Center Cheboygan, MI 231-627-3381		Vehicle serviced Tires rotated Fluids checked Oil and filter changed Body lubricated Drivability/performance checked Steering wheel centered Tire condition and pressure checked Steering/suspension checked Four wheel alignment performed Alignment checked
08/19/2010	90,450	Lahaie's Auto Service Center Cheboygan, MI 231-627-3381		Vehicle serviced Fluids checked Oil and filter changed Body lubricated Air filter replaced
11/09/2010	94,060	Lahaie's Auto Service Center Cheboygan, MI 231-627-3381		Vehicle serviced Fluids checked Oil and filter changed Body lubricated
01/17/2011	98,777	Lahaie's Auto Service Center Cheboygan, MI 231-627-3381		Vehicle serviced Fluids checked Oil and filter changed Body lubricated Antifreeze/coolant checked
01/31/2011		Damage Report		Accident reported: very minor damage It hit a parked motor vehicle Damage to right rear

[^ Back To Top](#)





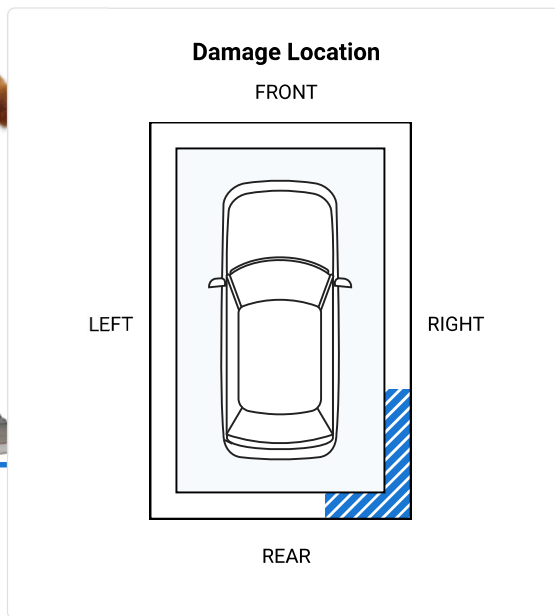
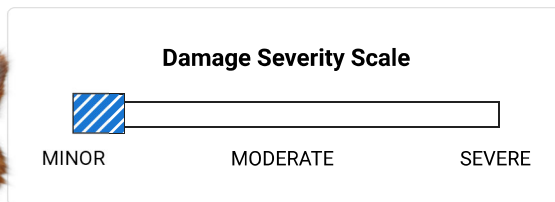



CARFAX HAS THE MOST ACCIDENT & DAMAGE INFORMATION









03/01/2011		Michigan Motor Vehicle Dept. Cheboygan, MI		Registration issued or renewed
03/28/2011	102,350	Lahaie's Auto Service Center Cheboygan, MI 231-627-3381		Vehicle serviced Fluids checked Oil and filter changed Body lubricated Drivability/performance checked Alignment checked Tire condition and pressure checked Steering/suspension checked Alignment performed Four wheel alignment performed
05/20/2011	104,897	Cherry Capital Cadillac Subaru LLC Traverse City, MI 231-947-9000 cherrycapital.com		Vehicle serviced Trim repaired
07/14/2011	107,000	Lahaie's Auto Service Center Cheboygan, MI 231-627-3381		Vehicle serviced Air filter checked Oil and filter changed Tire condition and pressure checked Body lubricated Tires rotated





[^ Back To Top](#)

11/09/2011	110,518	Lahaie's Auto Service Center Cheboygan, MI 231-627-3381		Vehicle serviced Fluids checked Oil and filter changed Body lubricated
02/07/2012	112,940	Lahaie's Auto Service Center Cheboygan, MI 231-627-3381		Vehicle serviced
03/12/2012		Michigan Motor Vehicle Dept. Cheboygan, MI		Registration issued or renewed
04/06/2012	115,191	Lahaie's Auto Service Center Cheboygan, MI 231-627-3381		Vehicle serviced Fluids checked Oil and filter changed Body lubricated Tires rotated
05/11/2012	116,600	Lahaie's Auto Service Center Cheboygan, MI 231-627-3381		Vehicle serviced Brakes replaced ABS system bled
09/18/2012	119,353	Bishop GMC Cadillac Cheboygan, MI 231-627-5669 bishopgmccadillac.com/ vehiclesearchresults? search=preowned ★ 4.8 / 5.0 170 Verified Reviews ❤️ 404 Customer Favorites		Vehicle serviced Body electrical system checked
10/24/2012	120,400	Lahaie's Auto Service Center Cheboygan, MI 231-627-3381		Vehicle serviced Oil and filter changed Fluids checked Wiper(s) replaced
01/18/2013	122,000	Lahaie's Auto Service Center Cheboygan, MI 231-627-3381		Vehicle serviced Brakes checked Oil and filter changed Spark plug(s) replaced Fuel filter replaced Transmission filter replaced
03/06/2013		Michigan Motor Vehicle Dept. Cheboygan, MI		Registration issued or renewed





[^ Back To Top](#)

03/11/2013	123,457	Dave Kring Chevrolet Petoskey, MI 231-347-2585 davekring.com		Vehicle serviced Remote(s) programmed
		★ 4.8 / 5.0 242 Verified Reviews ❤️ 18 Customer Favorites		
05/17/2013	125,182	Dave Kring Chevrolet Petoskey, MI 231-347-2585 davekring.com		Vehicle serviced A/C system checked
		★ 4.8 / 5.0 242 Verified Reviews ❤️ 18 Customer Favorites		
06/12/2013	125,254	Lahaie's Auto Service Center Cheboygan, MI 231-627-3381		Vehicle serviced Oil and filter changed Air filter replaced A/C refrigerant recharged A/C system serviced A/C hose/line replaced
10/18/2013	127,560	Lahaie's Auto Service Center Cheboygan, MI 231-627-3381		Vehicle serviced Drivability/performance checked Tire condition and pressure checked Steering/suspension checked Alignment checked
11/06/2013	James Wood Auto Park Denton, TX 469-556-2008 jameswooddenton.com/			Vehicle serviced Key(s) (re) programmed Anti-theft/keyless remote(s) replaced Electrical system checked
		★ 4.7 / 5.0 855 Verified Reviews ❤️ 14,817 Customer Favorites		
12/19/2013	131,513	Kuni Chevrolet Cadillac Sacramento, CA 916-929-2777 kunichevycadillac.com		Vehicle serviced Maintenance inspection completed Electrical system checked
		★ 4.4 / 5.0 30 Verified Reviews		
03/24/2014	Michigan Motor Vehicle Dept. Cheboygan, MI		Registration issued or renewed	



[^ Back To Top](#)

04/18/2014	136,331	Kuni Chevrolet Cadillac Sacramento, CA 916-929-2777 kunichevy Cadillac.com ★ 4.4 / 5.0 30 Verified Reviews		Vehicle serviced Maintenance inspection completed Radio/sound system checked Drivability/performance checked Electrical system checked
05/20/2014	137,316	DAVES AUTO REPAIR Nevada City, CA 530-265-6706		Vehicle serviced
03/02/2015		Michigan Motor Vehicle Dept. Cheboygan, MI		Registration issued or renewed Registration updated when owner moved the vehicle to a new location
08/03/2015		Michigan Motor Vehicle Dept. Cheboygan, MI		Registration issued or renewed
09/01/2015	152,912	Bishop GMC Cadillac Cheboygan, MI 231-627-5669 bishopgmccadillac.com/ vehiclesearchresults? search=preowned ★ 4.8 / 5.0 170 Verified Reviews ❤️ 404 Customer Favorites		Vehicle serviced
02/03/2016		Michigan Motor Vehicle Dept. Cheboygan, MI		Registration issued or renewed Registration updated when owner moved the vehicle to a new location
02/04/2016	157,991	Dave Kring Chevrolet Petoskey, MI 231-347-2585 davekring.com ★ 4.8 / 5.0 242 Verified Reviews ❤️ 18 Customer Favorites		Vehicle serviced
04/01/2016		Michigan Motor Vehicle Dept. Cheboygan, MI		Registration issued or renewed

[^ Back To Top](#)

06/01/2016 162,174	Dave Kring Chevrolet Petoskey, MI 231-347-2585 davekring.com		Vehicle serviced
	★ 4.8 / 5.0 242 Verified Reviews ❤️ 18 Customer Favorites		
08/09/2016 165,597	Dave Kring Chevrolet Petoskey, MI 231-347-2585 davekring.com		Vehicle serviced Maintenance inspection completed Four wheel alignment performed Alignment performed Four tires balanced Tire(s) balanced One tire balanced
	★ 4.8 / 5.0 242 Verified Reviews ❤️ 18 Customer Favorites		
11/11/2016 168,814	Dave Kring Chevrolet Petoskey, MI 231-347-2585 davekring.com		Vehicle serviced Vehicle washed/detailed
	★ 4.8 / 5.0 242 Verified Reviews ❤️ 18 Customer Favorites		
01/10/2017 171,315	Dave Kring Chevrolet Petoskey, MI 231-347-2585 davekring.com		Vehicle serviced
	★ 4.8 / 5.0 242 Verified Reviews ❤️ 18 Customer Favorites		
01/27/2017 171,639	Dave Kring Chevrolet Petoskey, MI 231-347-2585 davekring.com		Vehicle serviced
	★ 4.8 / 5.0 242 Verified Reviews ❤️ 18 Customer Favorites		
03/14/2017	Michigan Motor Vehicle Dept. Petoskey, MI		Registration issued or renewed Registration updated when owner moved the vehicle to a new location

[^ Back To Top](#)

04/20/2017 177,224	Dave Kring Chevrolet Petoskey, MI 231-347-2585 davekring.com		Vehicle serviced Drivability/performance checked ABS system checked
★ 4.8 / 5.0 242 Verified Reviews ❤️ 18 Customer Favorites			
05/25/2017 178,595	Dave Kring Chevrolet Petoskey, MI 231-347-2585 davekring.com		Vehicle serviced
★ 4.8 / 5.0 242 Verified Reviews ❤️ 18 Customer Favorites			
03/07/2018	Michigan Motor Vehicle Dept. Petoskey, MI	Registration issued or renewed	
01/27/2019	Damage Report		Accident reported: minor damage Involving multiple impact areas It hit a ditch Damage to front Damage to left front Damage to left rear Damage to rear Functional damage reported

^ [Back To Top](#)



CARFAX HAS THE MOST ACCIDENT & DAMAGE INFORMATION

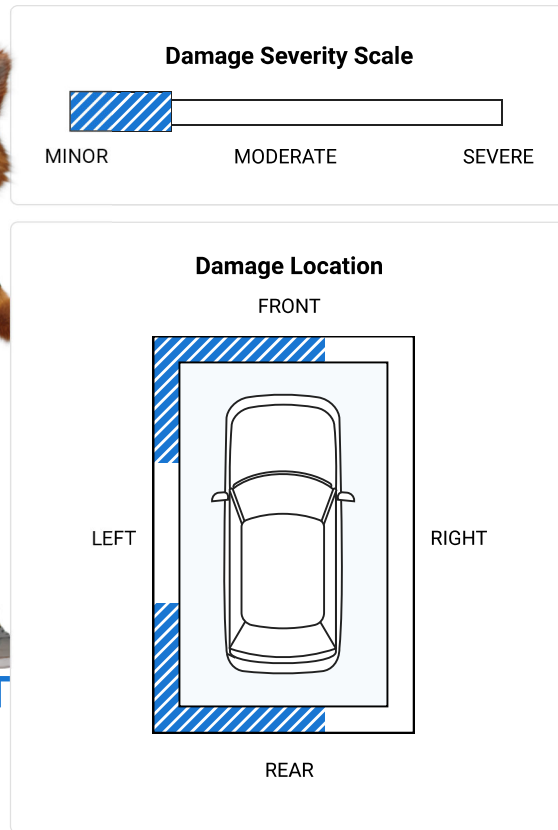

04/04/2019	Michigan Motor Vehicle Dept. Petoskey, MI Title #MI0001066061	Title issued or updated Registration issued or renewed Duplicate title issued
02/12/2020	Michigan Motor Vehicle Dept. Petoskey, MI	Registration issued or renewed
03/23/2021	Michigan Motor Vehicle Dept. Petoskey, MI	Registration issued or renewed
04/08/2022	Michigan Motor Vehicle Dept. Petoskey, MI	Registration issued or renewed
08/17/2023	Michigan Motor Vehicle Dept. Petoskey, MI	Registration issued or renewed

Have Questions? Consumers, please visit our Help Center at www.carfax.com. Dealers or Subscribers, please visit our Help Center at www.carfaxonline.com.



Glossary

^ **Back To Top**

Accident Indicator

CARFAX receives information about accidents in all 50 states, the District of Columbia and Canada.

Not every accident is reported to CARFAX. As details about the accident become available, those additional details are added to the CARFAX Vehicle History Report. CARFAX recommends that you have this vehicle inspected by a qualified mechanic.

- According to the National Safety Council, Injury Facts, 2021 edition, 5% of the 276 million registered vehicles in the U.S. were involved in an accident in 2019. Over 77% of these were considered minor or moderate.
- This CARFAX Vehicle History Report is based only on information supplied to CARFAX and available as of 8/31/24 at 6:49:02 AM (CDT). Other information about this vehicle, including problems, may not have been reported to CARFAX. Use this report as one important tool, along with a vehicle inspection and test drive, to make a better decision about your next used car.

Damage Severity

Damage events result in one of the following severity levels:

- Minor: Generally, minor damage is cosmetic (including dents or scratches), may only require reconditioning, and typically does not compromise a vehicle's operation and/or safety.
- Moderate: Moderate damage may affect multiple components of the vehicle and may impair the vehicle's operation and/or safety.
- Severe: Severe damage usually affects multiple components of the vehicle and is likely to compromise the vehicle's operation and/or safety.

CARFAX recommends getting a pre-purchase inspection at a certified collision repair facility.

First Owner

When the first owner(s) obtains a title from a Department of Motor Vehicles as proof of ownership.

Fleet Vehicle

Vehicle was registered or sold to a company that manages vehicle fleets.

Lease

When someone leases a car from a dealer, the dealer actually sells the vehicle to a leasing company. The leasing company then collects payments for the vehicle from the new owner for 24, 36, 48 or more months. A leasing company can be an independent car dealer or a car manufacturer.

New Owner Reported

When a vehicle is sold to a new owner, the Title must be transferred to the new owner(s) at a Department of Motor Vehicles.

Ownership History

CARFAX defines an owner as an individual or business that possesses and uses a vehicle. Not all title transactions represent changes in ownership. To provide estimated number of owners, CARFAX proprietary technology analyzes all the events in a vehicle history. Estimated ownership is available for vehicles manufactured after 1991 and titled solely in the US including Puerto Rico. Dealers sometimes opt to take ownership of a vehicle and are required to in the following states: Maine, Massachusetts, New Jersey, Ohio, Oklahoma, Pennsylvania and South Dakota. Please consider this as you review a vehicle's estimated ownership history.

Title Issued

A state issues a title to provide a vehicle owner with proof of ownership. Each title has a unique number. Each title or registration record on a CARFAX report does not necessarily indicate a change in ownership. In Canada, a registration and bill of sale are used as proof of ownership.

Follow Us:



facebook.com/CARFAX



@CARFAXinc



About CARFAX

CARFAX DEPENDS ON ITS SOURCES FOR THE ACCURACY AND RELIABILITY OF ITS INFORMATION. THEREFORE, NO RESPONSIBILITY IS ASSUMED BY CARFAX OR ITS AGENTS FOR ERRORS OR OMISSIONS IN THIS REPORT. CARFAX FURTHER EXPRESSLY DISCLAIMS ALL WARRANTIES, EXPRESS OR IMPLIED, INCLUDING ANY IMPLIED WARRANTIES OF MERCHANTABILITY OR PARTICULAR PURPOSE.

^ Back To Top

© 2024 CARFAX, Inc., part of S&P Global. All rights reserved.

8/31/24 6:49:02 AM (CDT)

I have reviewed and received a copy of the CARFAX Vehicle History Report for this 2004 CADILLAC SRX vehicle (VIN: 1GYDE63A040100190), which is based on information supplied to CARFAX and available as of 8/31/24 at 7:49 AM (EDT).

Customer Signature

Date

Dealer Signature

Date

[^ Back To Top](#)