



### History-Based Value Report

#### History events affecting this vehicle's value



1

1-Owner Vehicle



Minor Damage

**\$14,910 Retail Value**



### Vehicle History Report™

US \$44.99

#### 2012 FORD E-SERIES E-350 SD XLT

VIN: 1FBSS3BL6CDB30717  
VAN  
5.4L V8 F SOHC 16V  
GASOLINE  
REAR WHEEL DRIVE  
Original Window Sticker

#### Accident reported: minor damage

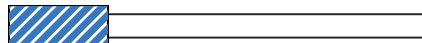

MINOR      MODERATE      SEVERE



2 Service history records



CARFAX 1-Owner vehicle



Last owned in Michigan



**76,817** Last reported odometer reading

This CARFAX Vehicle History Report is based only on information supplied to CARFAX and available as of 7/2/24 at

5:20:53 PM (CDT). Other information about this vehicle, including problems, may not have been reported to CARFAX. Use this report as one important tool, along with a vehicle inspection and test drive, to make a better decision about your next used car.



### Accident / Damage History

Not all accidents / issues are reported to CARFAX

#### Event 1

06/03/2016

**Damage reported:  
minor damage**

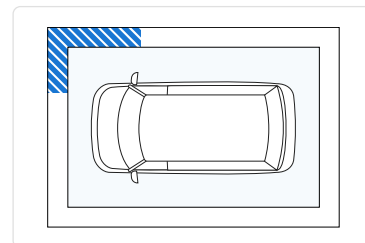
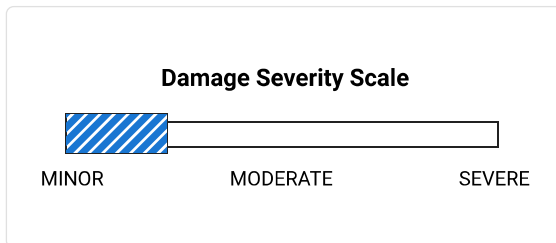

#### Event 2

04/12/2018

**Accident reported:  
minor damage with  
another motor vehicle**

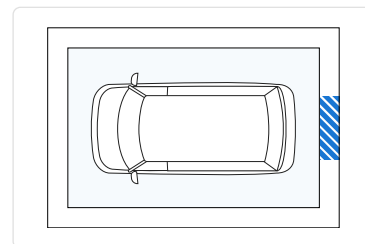
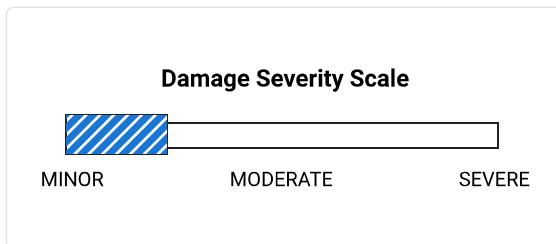

### Additional History

Not all accidents / issues are reported to CARFAX

#### Owner 1

**Total Loss**

No total loss reported to CARFAX.

✓ No Issues Reported

**Structural Damage**

CARFAX recommends that you have this vehicle inspected by a collision repair specialist.

✓ No Issues Reported

**Airbag Deployment**

No airbag deployment reported to CARFAX.

✓ No Issues Reported

**Odometer Check**

No indication of an odometer rollback.



✓ No Issues Indicated

**Accident / Damage**

Damage reported: 06/03/2016. Accident reported: 04/12/2018.



Minor Damage



<p><b>Manufacturer Recall</b> A current list of recalls is available at Ford Motor Company.</p>	<p><input checked="" type="checkbox"/> No Recalls Reported</p>
<p><b>Basic Warranty</b> Original warranty estimated to have expired.</p>	<p><b>Warranty Expired</b></p>

<p> <b>Title History</b> CARFAX guarantees the information in this section</p>	<p><b>Owner 1</b></p>
<p><b>Damage Brands</b> Salvage   Junk   Rebuilt   Fire   Flood   Hail   Lemon</p>	<p><input checked="" type="checkbox"/> <b>Guaranteed</b> No Problem</p>
<p><b>Odometer Brands</b> Not Actual Mileage   Exceeds Mechanical Limits</p>	<p><input checked="" type="checkbox"/> <b>Guaranteed</b> No Problem</p>
<p> <b>GUARANTEED</b> - None of these title problems were reported by a U.S. state Department of Motor Vehicles (DMV). If you find that any of these title problems were reported by a DMV and not included in this report, you may qualify. <a href="#">View Terms</a>   <a href="#">View Certificate</a></p>	

<p> <b>Ownership History</b> The number of owners is estimated</p>	<p><b>Owner 1</b></p>
Year purchased	2012
Type of owner	---
Estimated length of ownership	11 yrs. 10 mo.
Owned in the following states/provinces	Michigan
Estimated miles driven per year	10,384/yr
Last reported odometer reading	76,817

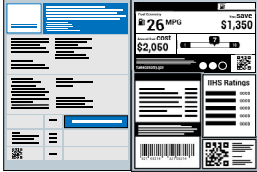

<p> <b>Detailed History</b></p>			
<p> <b>Owner 1</b> Purchased: 2012</p>			<p>10,384 mi/yr</p>
<b>Date</b>	<b>Mileage</b>	<b>Source</b>	<b>Comments</b>
Empty table body for detailed history			

<p>07/27/2012</p>	<p>Ford Motor Company</p>	<p><b>Vehicle manufactured and shipped to original dealer</b></p>  <p>Original Window Sticker</p>
<p>07/27/2012 3</p>	<p>Gorno Ford Woodhaven, MI 734-676-0031 gornoford.com</p> <p>★ 4.5 / 5.0 403 Verified Reviews</p> <p>♥ 4,216 Customer Favorites</p>	<p><b>Vehicle offered for sale</b></p>
<p>08/03/2012 5</p>	<p>Gorno Ford Woodhaven, MI 734-676-0031 gornoford.com</p> <p>★ 4.5 / 5.0 403 Verified Reviews</p> <p>♥ 4,216 Customer Favorites</p>	<p> <b>Vehicle serviced</b> Pre-delivery inspection completed</p>
<p>08/09/2012 200</p>	<p>Michigan Motor Vehicle Dept. Kalamazoo, MI Title #110A2220377</p>	<p><b>Title issued or updated</b> First owner reported</p>
<p>06/03/2016</p>	<p>Damage Report</p>	<p> <b>Damage reported: minor damage</b> Damage to right front</p>



**CARFAX HAS THE MOST ACCIDENT & DAMAGE INFORMATION**

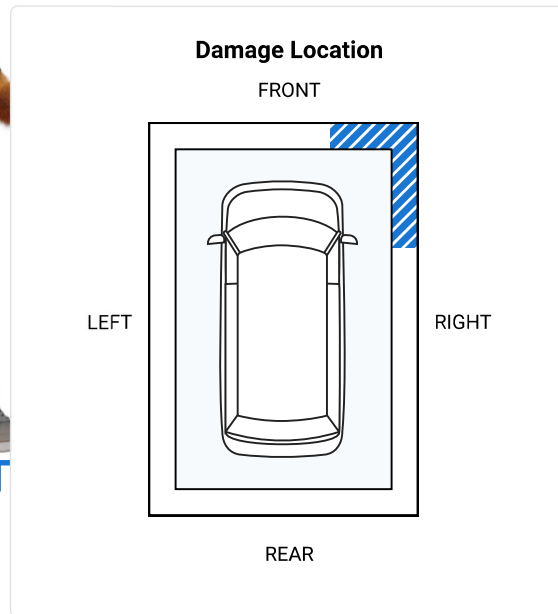
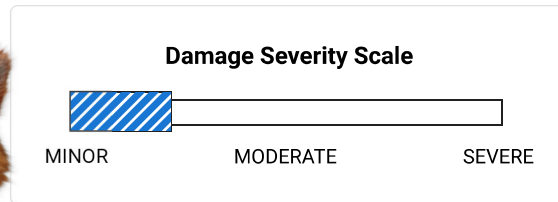

Minor damage is usually cosmetic, including dents or scratches to the vehicle body.

04/12/2018

Damage Report



**Accident reported: minor damage with another motor vehicle**  
Damage to rear



## CARFAX HAS THE MOST ACCIDENT & DAMAGE INFORMATION

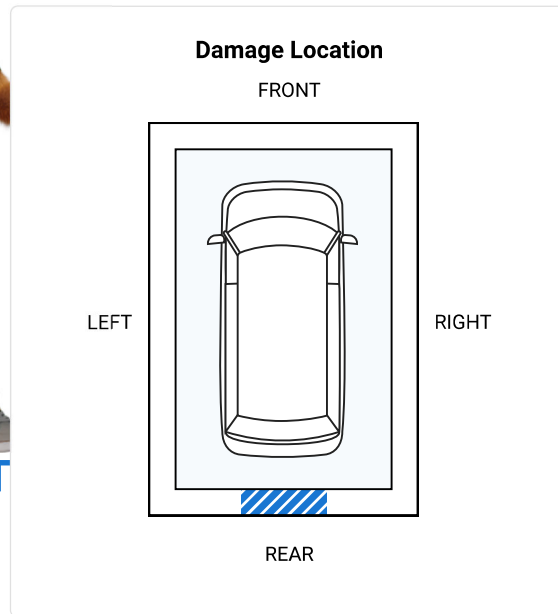
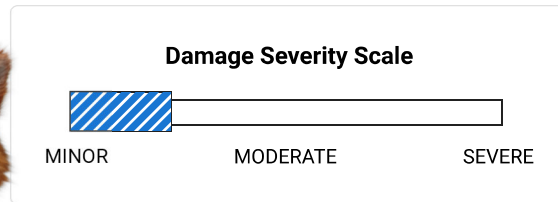

Minor damage is usually cosmetic, including dents or scratches to the vehicle body.

12/31/2019 76,817 Dorrance Ford  
Galesburg, MI  
269-665-7015  
dorrancefordgalesburg.com



**Vehicle serviced**  
Steering/suspension checked  
Two wheel alignment performed

★ **4.8 / 5.0**  
290 Verified Reviews  
♥ **2,067** Customer Favorites



Hmm, we haven't received any information on this car since December 2019. Before you buy, ask the seller for recent service or repair records.

Have Questions? Consumers, please visit our Help Center at [www.carfax.com](http://www.carfax.com). Dealers or Subscribers, please visit our Help Center at [www.carfaxonline.com](http://www.carfaxonline.com).



### Glossary

#### Accident Indicator

CARFAX receives information about accidents in all 50 states, the District of Columbia and Canada.

Not every accident is reported to CARFAX. As details about the accident become available, those additional details are added to the CARFAX Vehicle History Report. CARFAX recommends that you have this vehicle inspected by a qualified mechanic.

- According to the National Safety Council, Injury Facts, 2021 edition, 5% of the 276 million registered vehicles in the U.S. were involved in an accident in 2019. Over 77% of these were considered minor or moderate.
- This CARFAX Vehicle History Report is based only on information supplied to CARFAX and available as of 7/2/24 at 5:20:53 PM (CDT). Other information about this vehicle, including problems, may not have been reported to CARFAX. Use this report as one important tool, along with a vehicle inspection and test drive, to make a better decision about your next used car.

### Damage Indicator

Damage can be a result of many different types of events. Examples include contact with objects (other cars, trees, traffic signs, road debris, etc), vandalism, or weather-related events. Not every damage event is reported to CARFAX. As details about the damage event become available, those additional details are added to the CARFAX Vehicle History Report. CARFAX recommends that you have this vehicle inspected by a qualified mechanic.

- This CARFAX Vehicle History Report is based only on information supplied to CARFAX and available as of 7/2/24 at 5:20:53 PM (CDT). Other information about this vehicle, including problems, may not have been reported to CARFAX. Use this report as one important tool, along with a vehicle inspection and test drive, to make a better decision about your next used car.

### Damage Severity

Damage events result in one of the following severity levels:

- Minor: Generally, minor damage is cosmetic (including dents or scratches), may only require reconditioning, and typically does not compromise a vehicle's operation and/or safety.
- Moderate: Moderate damage may affect multiple components of the vehicle and may impair the vehicle's operation and/or safety.
- Severe: Severe damage usually affects multiple components of the vehicle and is likely to compromise the vehicle's operation and/or safety.

CARFAX recommends getting a pre-purchase inspection at a certified collision repair facility.

### First Owner

When the first owner(s) obtains a title from a Department of Motor Vehicles as proof of ownership.

### Ford or Lincoln Mercury Recall

The Ford Motor Company provides CARFAX with Field Service Action and recall information regarding safety, compliance and emissions programs announced since 2000 for a specific vehicle. For complete information regarding programs or concerns about this vehicle, please contact a local Ford or Lincoln Mercury Dealer.

### Ownership History

CARFAX defines an owner as an individual or business that possesses and uses a vehicle. Not all title transactions represent changes in ownership. To provide estimated number of owners, CARFAX proprietary technology analyzes all the events in a vehicle history. Estimated ownership is available for vehicles manufactured after 1991 and titled solely in the US including Puerto Rico. Dealers sometimes opt to take ownership of a vehicle and are required to in the following states: Maine, Massachusetts, New Jersey, Ohio, Oklahoma, Pennsylvania and South Dakota. Please consider this as you review a vehicle's estimated ownership history.

### Title Issued

A state issues a title to provide a vehicle owner with proof of ownership. Each title has a unique number. Each title or registration record on a CARFAX report does not necessarily indicate a change in ownership. In Canada, a registration and bill of sale are used as proof of ownership.

Follow Us:



[facebook.com/CARFAX](https://www.facebook.com/CARFAX)



[@CARFAXinc](https://twitter.com/CARFAXinc)



About CARFAX

CARFAX DEPENDS ON ITS SOURCES FOR THE ACCURACY AND RELIABILITY OF ITS INFORMATION. THEREFORE, NO RESPONSIBILITY

IS ASSUMED BY CARFAX OR ITS AGENTS FOR ERRORS OR OMISSIONS IN THIS REPORT. CARFAX FURTHER EXPRESSLY DISCLAIMS ALL WARRANTIES, EXPRESS OR IMPLIED, INCLUDING ANY IMPLIED WARRANTIES OF MERCHANTABILITY OR FITNESS FOR A PARTICULAR PURPOSE.

© 2024 CARFAX, Inc., part of S&P Global. All rights reserved.  
7/2/24 5:20:53 PM (CDT)

**I have reviewed and received a copy of the CARFAX Vehicle History Report for this 2012 FORD E-SERIES vehicle (VIN: 1FBSS3BL6CDB30717), which is based on information supplied to CARFAX and available as of 7/2/24 at 6:20 PM (EDT).**

---

**Customer Signature**

**Date**

---

**Dealer Signature**

**Date**