



### History-Based Value Report

**\$5,070**

CARFAX Retail Value

#### History events affecting this vehicle's value

- Service History
- Personal Vehicle
- Prior Certified Pre-Owned
- Minor Damage



### Vehicle History Report™

US \$44.99

**2010 SUBARU  
OUTBACK 2.5I LIMITED**

VIN: 4S4BRCKC7A3372180  
4 DOOR WAGON/SPORT  
UTILITY  
2.5L H4 F SOHC 16V  
GASOLINE  
ALL WHEEL DRIVE

**Damage reported: minor damage**

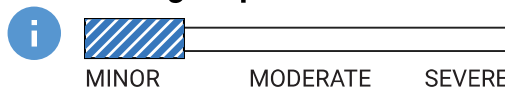

**37** Service history records

**3** Previous owners

Personal vehicle

**202,015** Last reported odometer reading



This CARFAX Vehicle History Report is based only on information supplied to CARFAX and available as of 11/8/24 at 2:55:36 PM (CST). Other information about this vehicle, including problems, may not have been reported to CARFAX. Use this report as one important tool, along with a vehicle inspection and test drive, to make a better decision about your next used car.

**CARFAX** Accident / Damage History

Not all accidents / issues are reported to CARFAX

Event 1

03/16/2016

**Damage reported: minor damage**

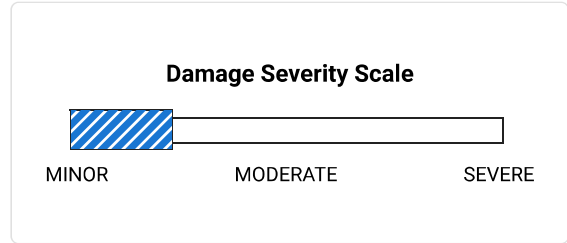

Event 2

03/05/2018

**Damage reported: minor damage**

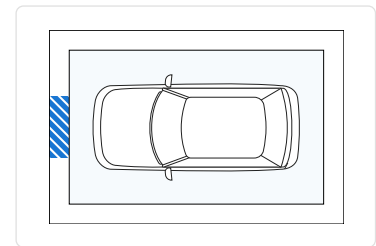
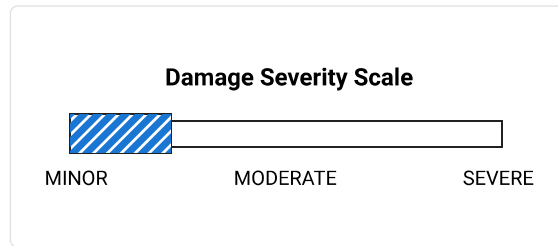

Event 3

02/07/2020

**Damage reported: minor damage**

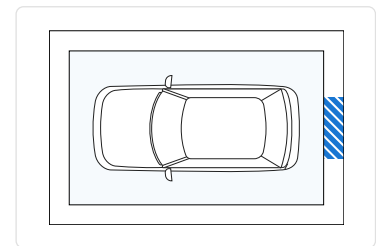
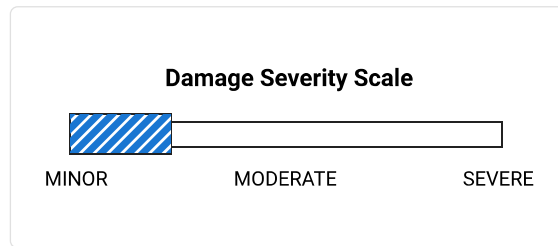



**CARFAX** Additional History

Not all accidents / issues are reported to CARFAX

	Owner 1	Owner 2	Owner 3
<b>Total Loss</b> No total loss reported to CARFAX.	<input checked="" type="checkbox"/> No Issues Reported	<input checked="" type="checkbox"/> No Issues Reported	<input checked="" type="checkbox"/> No Issues Reported

<b>Structural Damage</b> CARFAX recommends that you have this vehicle inspected by a collision repair specialist.	<input checked="" type="checkbox"/> No Issues Reported	<input checked="" type="checkbox"/> No Issues Reported	<input checked="" type="checkbox"/> No Issues Reported
<b>Airbag Deployment</b> No airbag deployment reported to CARFAX.	<input checked="" type="checkbox"/> No Issues Reported	<input checked="" type="checkbox"/> No Issues Reported	<input checked="" type="checkbox"/> No Issues Reported
<b>Odometer Check</b> No indication of an odometer rollback.	<input checked="" type="checkbox"/> No Issues Indicated	<input checked="" type="checkbox"/> No Issues Indicated	<input checked="" type="checkbox"/> No Issues Indicated
<b>Accident / Damage</b> Damage reported: 03/16/2016, 03/05/2018, and 02/07/2020.	<input checked="" type="checkbox"/> No Issues Reported	Minor Damage	No New Issues Reported
<b>Manufacturer Recall</b> No open recalls reported to CARFAX.	<input checked="" type="checkbox"/> No Recalls Reported	<input checked="" type="checkbox"/> No Recalls Reported	<input checked="" type="checkbox"/> No Recalls Reported
<b>Basic Warranty</b> Original warranty estimated to have expired.	<b>Warranty Expired</b>	<b>Warranty Expired</b>	<b>Warranty Expired</b>

 <b>Title History</b> CARFAX guarantees the information in this section	Owner 1	Owner 2	Owner 3
<b>Damage Brands</b> Salvage   Junk   Rebuilt   Fire   Flood   Hail   Lemon	<input checked="" type="checkbox"/> <b>Guaranteed</b> No Problem	<input checked="" type="checkbox"/> <b>Guaranteed</b> No Problem	<input checked="" type="checkbox"/> <b>Guaranteed</b> No Problem
<b>Odometer Brands</b> Not Actual Mileage   Exceeds Mechanical Limits	<input checked="" type="checkbox"/> <b>Guaranteed</b> No Problem	<input checked="" type="checkbox"/> <b>Guaranteed</b> No Problem	<input checked="" type="checkbox"/> <b>Guaranteed</b> No Problem





**GUARANTEED** - None of these title problems were reported by a U.S. state Department of Motor Vehicles (DMV). If you find that any of these title problems were reported by a DMV and not included in this report, you may qualify.  
[View Terms](#) | [View Certificate](#)

 <b>Ownership History</b> The number of owners is estimated	Owner 1	Owner 2	Owner 3
Year purchased	2010	2011	2020
Type of owner	Personal	Personal	Personal
Estimated length of ownership	9 months	9 yrs. 3 mo.	4 yrs. 3 mo.
Owned in the following states/provinces	Michigan	Michigan	Michigan
Estimated miles driven per year	---	12,636/yr	---
Last reported odometer reading	8,615	122,820	202,015

**Detailed History**
**Owner 1**

Purchased: 2010

Personal Vehicle

Date	Mileage	Source	Comments
03/26/2010		Dunning Subaru Ann Arbor, MI 734-662-3444 subaruofannarbor.com ★ 4.5 / 5.0 77 Verified Reviews	 <b>Vehicle serviced</b> Pre-delivery inspection completed
04/07/2010	4	Michigan Motor Vehicle Dept. Saint Clair, MI Title #603Y0970622	<b>Title or registration issued</b> First owner reported Titled or registered as personal vehicle
08/24/2010	3,370	Suburban Collection suburbancollection.com ★ 4.6 / 5.0 668 Verified Reviews	 <b>Vehicle serviced</b> Recommended maintenance performed Steering/suspension checked
11/19/2010		Michigan Motor Vehicle Dept. Saint Clair, MI	<b>Registration issued or renewed</b>
01/28/2011		Dunning Toyota Scion Ann Arbor Ann Arbor, MI 734-997-7600 dunningtoyota.com ★ 4.3 / 5.0 115 Verified Reviews	<b>Vehicle offered for sale</b>
01/31/2011	8,598	Subaru Certified Dealer Ann Arbor, MI 	<b>Offered for sale as a Subaru Certified Pre-owned Vehicle</b>
01/31/2011	8,615	Dunning Subaru Ann Arbor, MI 734-662-3444 subaruofannarbor.com ★ 4.5 / 5.0 77 Verified Reviews	 <b>Vehicle serviced</b> Pre-delivery inspection completed

**Owner 2**

Purchased: 2011



**Low mileage!** This owner drove less than the industry average of 15,000 miles per year.

Personal Vehicle

12,636 mi/yr

Date	Mileage	Source		Comments
02/22/2011	8,642	Michigan Motor Vehicle Dept. Ann Arbor, MI Title #603Z0530427		<b>Title or registration issued</b> New owner reported
09/28/2011	20,264	Dunning Subaru Ann Arbor, MI 734-662-3444 subaruofannarbor.com ★ 4.5 / 5.0 77 Verified Reviews		<b>Vehicle serviced</b> Engine/powertrain computer/module reprogrammed Computer reprogrammed
12/15/2011		Michigan Motor Vehicle Dept. Ann Arbor, MI		<b>Registration issued or renewed</b>
12/29/2011	24,466	Dunning Subaru Ann Arbor, MI 734-662-3444 subaruofannarbor.com ★ 4.5 / 5.0 77 Verified Reviews		<b>Vehicle serviced</b> Recommended maintenance performed
12/07/2012		Michigan Motor Vehicle Dept. Ann Arbor, MI		<b>Registration issued or renewed</b>
12/10/2013		Michigan Motor Vehicle Dept. Ann Arbor, MI		<b>Registration issued or renewed</b>
03/25/2014		Michigan Motor Vehicle Dept. Ann Arbor, MI Title #109C0840354		<b>Title issued or updated</b> Correction to record
12/16/2014		Michigan Motor Vehicle Dept. Ann Arbor, MI		<b>Registration issued or renewed</b>
12/14/2015		Michigan Motor Vehicle Dept. Ann Arbor, MI		<b>Registration issued or renewed</b>
03/16/2016		Damage Report		<b>Damage reported: minor damage</b>

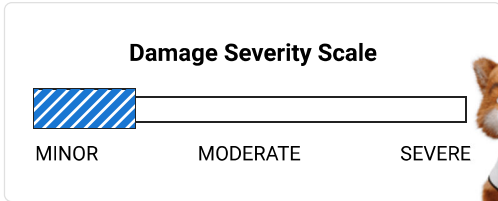

Minor damage is usually cosmetic, including dents or scratches to the vehicle body.

11/29/2016		Michigan Motor Vehicle Dept. Ann Arbor, MI		<b>Registration issued or renewed</b>
07/12/2017	104,545	Subaru of Ann Arbor Ann Arbor, MI 734-662-3444 subaruofannarbor.com ★ 4.5 / 5.0 375 Verified Reviews ❤️ 1,200 Customer Favorites		<b>Vehicle serviced</b> Maintenance inspection completed 3,750 mile service performed A/C and heating system checked Oil and filter changed Fluids checked
08/28/2017	106,014	Subaru of Ann Arbor Ann Arbor, MI 734-662-3444 subaruofannarbor.com ★ 4.5 / 5.0 375 Verified Reviews ❤️ 1,200 Customer Favorites		<b>Vehicle serviced</b> Maintenance inspection completed A/C and heating system checked Tire condition and pressure checked
11/08/2017	108,514	Dunning Subaru Ann Arbor, MI 734-662-3444 subaruofannarbor.com ★ 4.5 / 5.0 77 Verified Reviews		<b>Vehicle serviced</b> Maintenance inspection completed A/C and heating system checked
11/30/2017	108,950	Dunning Subaru Ann Arbor, MI 734-662-3444 subaruofannarbor.com ★ 4.5 / 5.0 77 Verified Reviews		<b>Vehicle serviced</b> Maintenance inspection completed Recommended maintenance performed Water pump replaced Timing belt replaced
12/20/2017		Michigan Motor Vehicle Dept. Ann Arbor, MI		<b>Registration issued or renewed</b>

02/23/2018 110,842 Dunning Subaru  
Ann Arbor, MI  
734-662-3444  
subaruofannarbor.com  
★ 4.5 / 5.0  
77 Verified Reviews



**Vehicle serviced**

Maintenance inspection completed  
Headlight bulb(s) replaced  
Light bulb(s) replaced

03/05/2018 Damage Report



**Damage reported: minor damage**

Damage to front



**CARFAX HAS THE MOST ACCIDENT & DAMAGE INFORMATION**

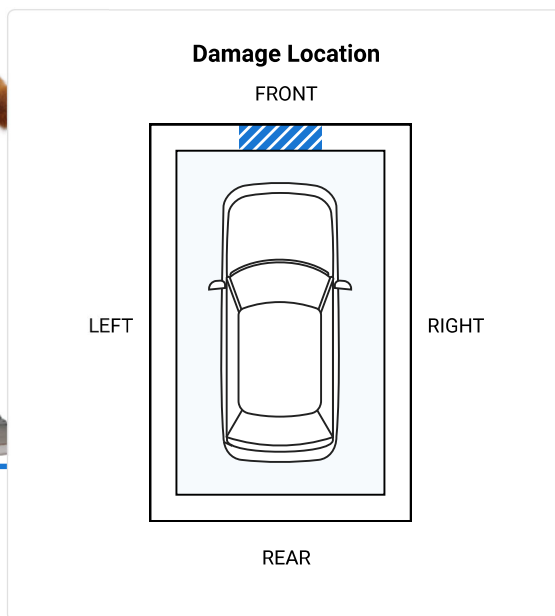
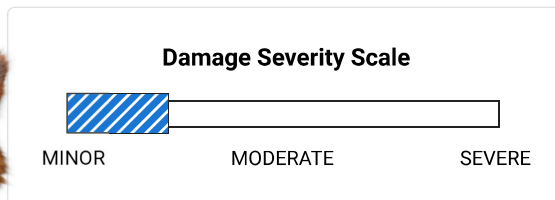

04/24/2018 111,567 Dunning Subaru  
Ann Arbor, MI  
734-662-3444  
subaruofannarbor.com  
★ 4.5 / 5.0  
77 Verified Reviews



**Vehicle serviced**





Maintenance inspection completed  
Vehicle washed/detailed  
Headlight bulb(s) replaced  
Light bulb(s) replaced

05/11/2018 111,787 Dunning Subaru  
Ann Arbor, MI  
734-662-3444  
subaruofannarbor.com  
★ 4.5 / 5.0  
77 Verified Reviews



**Vehicle serviced**

Maintenance inspection completed  
Wheels checked

07/06/2018	113,075	Dunning Subaru Ann Arbor, MI 734-662-3444 subaruofannarbor.com ★ 4.5 / 5.0 77 Verified Reviews		<b>Vehicle serviced</b> Recommended maintenance performed Maintenance inspection completed Vehicle washed/detailed Cabin air filter replaced/cleaned
11/19/2018	115,532	Dunning Subaru Ann Arbor, MI 734-662-3444 subaruofannarbor.com ★ 4.5 / 5.0 77 Verified Reviews		<b>Vehicle serviced</b> Recommended maintenance performed Maintenance inspection completed
12/07/2018		Michigan Motor Vehicle Dept. Ann Arbor, MI		<b>Registration issued or renewed</b>
06/06/2019	117,855	Dunning Subaru Ann Arbor, MI 734-662-3444 subaruofannarbor.com ★ 4.5 / 5.0 77 Verified Reviews		<b>Vehicle serviced</b> Maintenance inspection completed 120,000 mile service performed Four wheel alignment performed Right airbag assembly replaced Differential fluid flushed/changed Rear brake pads replaced Rear brake rotor(s) replaced Alignment checked Exterior lights checked Airbag system checked Rear differential fluid flushed/ changed Rear differential serviced Front differential fluid flushed/ changed
08/23/2019	119,268	Subaru of Ann Arbor Ann Arbor, MI 734-662-3444 subaruofannarbor.com ★ 4.5 / 5.0 375 Verified Reviews ❤️ 1,200 Customer Favorites		<b>Vehicle serviced</b> Tire condition and pressure checked
12/10/2019		Michigan Motor Vehicle Dept. Ann Arbor, MI		<b>Registration issued or renewed</b>



02/04/2020 122,031 Dunning Subaru  
Ann Arbor, MI  
734-662-3444  
subaruofannarbor.com  
★ 4.5 / 5.0  
77 Verified Reviews



**Vehicle serviced**  
Maintenance inspection completed  
7,500 mile service performed

02/07/2020 Damage Report



**Damage reported: minor damage**  
Damage to rear



**CARFAX HAS THE MOST  
ACCIDENT & DAMAGE  
INFORMATION**

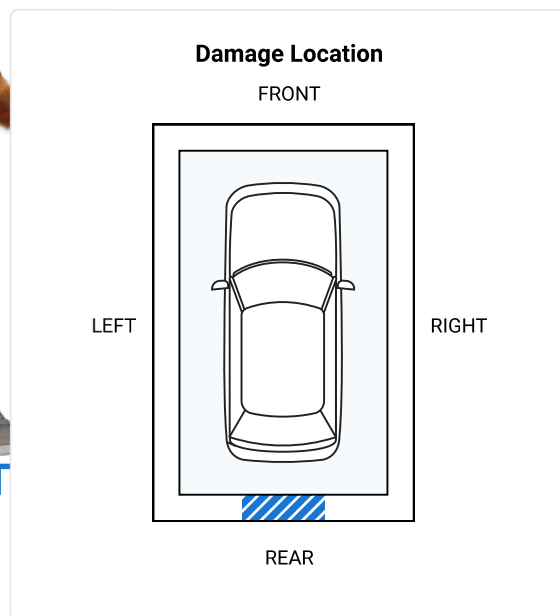
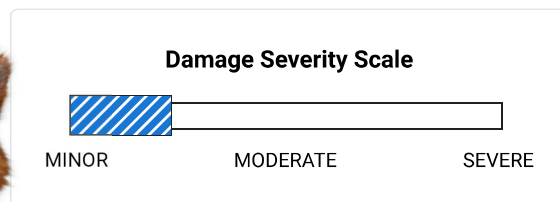

03/04/2020 122,820 Dunning Subaru  
Ann Arbor, MI  
734-662-3444  
subaruofannarbor.com  
★ 4.5 / 5.0  
77 Verified Reviews



**Vehicle serviced**  
Maintenance inspection completed

06/12/2020 Michigan  
Motor Vehicle Dept.





**Vehicle purchase reported**





07/09/2020 Michigan  
Motor Vehicle Dept.  
Lansing, MI





**Registration issued or renewed**





**Owner 3**  
Purchased: 2020

Personal Vehicle

Date	Mileage	Source	Comments
07/09/2020		Michigan Motor Vehicle Dept. Lansing, MI Title #MI0005785002	<b>Title issued or updated</b> New owner reported Exempt from odometer reporting
10/13/2020	128,124	Williams Hyundai Lansing, MI 517-484-1341 lansinghyundai.com ★ <b>4.5 / 5.0</b> 294 Verified Reviews ❤️ <b>252</b> Customer Favorites	 <b>Vehicle serviced</b> Maintenance inspection completed Oil and filter changed
03/09/2021	132,131	Quality Tire Inc Lansing, MI 517-321-0119 qualitytirelansing.com ★ <b>5.0 / 5.0</b> 75 Verified Reviews ❤️ <b>18</b> Customer Favorites	 <b>Vehicle serviced</b>
05/21/2021		Michigan Motor Vehicle Dept. Lansing, MI	<b>Registration issued or renewed</b>
07/12/2021	136,890	Big Ray's Express Lube Lansing, MI 517-323-4613 big rays express lube lansing mi ★ <b>4.7 / 5.0</b> 38 Verified Reviews ❤️ <b>57</b> Customer Favorites	 <b>Vehicle serviced</b> Tires rotated Oil and filter changed
07/15/2021	137,021	Williams Hyundai Lansing, MI 517-484-1341 lansinghyundai.com ★ <b>4.5 / 5.0</b> 294 Verified Reviews ❤️ <b>252</b> Customer Favorites	 <b>Vehicle serviced</b> Maintenance inspection completed Oil and filter changed Light bulb(s) replaced

08/02/2021	138,157	Williams Hyundai Lansing, MI 517-484-1341 lansinghyundai.com ★ 4.5 / 5.0 294 Verified Reviews ♥ 252 Customer Favorites		<b>Vehicle serviced</b> Maintenance inspection completed Seat or seat upholstery repaired Oil and filter changed Brakes checked
08/16/2021	138,165	Redline Auto Service Lansing, MI 517-367-7070 redlineautoservice.com/ ★ 4.9 / 5.0 59 Verified Reviews ♥ 24 Customer Favorites		<b>Vehicle serviced</b> Wiper(s) replaced
02/03/2022	146,571	Williams Hyundai Lansing, MI 517-484-1341 lansinghyundai.com ★ 4.5 / 5.0 294 Verified Reviews ♥ 252 Customer Favorites		<b>Vehicle serviced</b> Maintenance inspection completed Engine/powertrain computer/module checked Oil and filter changed Brakes checked
02/28/2022	147,393	Redline Auto Service Lansing, MI 517-367-7070 redlineautoservice.com/ ★ 4.9 / 5.0 59 Verified Reviews ♥ 24 Customer Favorites		<b>Vehicle serviced</b> Exhaust system checked Exhaust pipe replaced
04/15/2022		Michigan Motor Vehicle Dept. Lansing, MI		<b>Registration issued or renewed</b>
05/05/2022	151,874	Redline Auto Service Lansing, MI 517-367-7070 redlineautoservice.com/ ★ 4.9 / 5.0 59 Verified Reviews ♥ 24 Customer Favorites		<b>Vehicle serviced</b> Throttle body cleaned/serviced Wheel bearing(s)/hub(s) replaced Engine/powertrain computer/module checked Oil and filter changed Oxygen sensor replaced

12/30/2022	162,905	Redline Auto Service Lansing, MI 517-367-7070 redlineautoservice.com/ ★ 4.9 / 5.0 59 Verified Reviews ❤️ 24 Customer Favorites		<b>Vehicle serviced</b>
01/20/2023	164,880	Redline Auto Service Lansing, MI 517-367-7070 redlineautoservice.com/ ★ 4.9 / 5.0 59 Verified Reviews ❤️ 24 Customer Favorites		<b>Vehicle serviced</b>
02/02/2023	165,191	Redline Auto Service Lansing, MI 517-367-7070 redlineautoservice.com/ ★ 4.9 / 5.0 59 Verified Reviews ❤️ 24 Customer Favorites		<b>Vehicle serviced</b> Axles checked
03/27/2023	168,068	Performance Plus Quick Oil Change & Car Wash Lansing, MI 517-351-0663 performanceplusoil.com ★ 4.9 / 5.0 48 Verified Reviews ❤️ 40 Customer Favorites		<b>Vehicle serviced</b> Vehicle washed/detailed Air filter replaced Oil and filter changed
04/17/2023		Michigan Motor Vehicle Dept. Lansing, MI		<b>Registration issued or renewed</b>
10/07/2023	182,983	Performance Plus Quick Oil Change & Car Wash Lansing, MI 517-351-0663 performanceplusoil.com ★ 4.9 / 5.0 48 Verified Reviews ❤️ 40 Customer Favorites		<b>Vehicle serviced</b> Air filter replaced Vehicle washed/detailed Oil and filter changed

03/09/2024	190,793	Performance Plus Quick Oil Change & Car Wash Lansing, MI 517-351-0663 performanceplusoil.com ★ <b>4.9 / 5.0</b> 48 Verified Reviews ♥ <b>40</b> Customer Favorites		<b>Vehicle serviced</b> Vehicle washed/detailed Oil and filter changed
03/18/2024	191,069	Redline Auto Service Lansing, MI 517-367-7070 redlineautoservice.com/ ★ <b>4.9 / 5.0</b> 59 Verified Reviews ♥ <b>24</b> Customer Favorites		<b>Vehicle serviced</b> Rear brake rotor(s) replaced Rear brake pads replaced
05/30/2024		Michigan Motor Vehicle Dept. Lansing, MI		<b>Registration issued or renewed</b>
07/06/2024	197,656	Performance Plus Quick Oil Change & Car Wash Lansing, MI 517-351-0663 performanceplusoil.com ★ <b>4.9 / 5.0</b> 48 Verified Reviews ♥ <b>40</b> Customer Favorites		<b>Vehicle serviced</b> Air filter replaced Vehicle washed/detailed Oil and filter changed
08/26/2024	200,995	Performance Plus Quick Oil Change & Car Wash Lansing, MI 517-351-0663 performanceplusoil.com ★ <b>4.9 / 5.0</b> 48 Verified Reviews ♥ <b>40</b> Customer Favorites		<b>Vehicle serviced</b> Vehicle washed/detailed Oil and filter changed
09/12/2024	202,015	Redline Auto Service Lansing, MI 517-367-7070 redlineautoservice.com/ ★ <b>4.9 / 5.0</b> 59 Verified Reviews ♥ <b>24</b> Customer Favorites		<b>Vehicle serviced</b>

Have Questions? Consumers, please visit our Help Center at [www.carfax.com](http://www.carfax.com). Dealers or Subscribers, please visit our Help Center at [www.carfaxonline.com](http://www.carfaxonline.com).



## Glossary

### Damage Indicator

Damage can be a result of many different types of events. Examples include contact with objects (other cars, trees, traffic signs, road debris, etc), vandalism, or weather-related events. Not every damage event is reported to CARFAX. As details about the damage event become available, those additional details are added to the CARFAX Vehicle History Report. CARFAX recommends that you have this vehicle inspected by a qualified mechanic.

- This CARFAX Vehicle History Report is based only on information supplied to CARFAX and available as of 11/8/24 at 2:55:36 PM (CST). Other information about this vehicle, including problems, may not have been reported to CARFAX. Use this report as one important tool, along with a vehicle inspection and test drive, to make a better decision about your next used car.

### Damage Severity

Damage events result in one of the following severity levels:

- **Minor:** Generally, minor damage is cosmetic (including dents or scratches), may only require reconditioning, and typically does not compromise a vehicle's operation and/or safety.
- **Moderate:** Moderate damage may affect multiple components of the vehicle and may impair the vehicle's operation and/or safety.
- **Severe:** Severe damage usually affects multiple components of the vehicle and is likely to compromise the vehicle's operation and/or safety.

CARFAX recommends getting a pre-purchase inspection at a certified collision repair facility.

### First Owner

When the first owner(s) obtains a title from a Department of Motor Vehicles as proof of ownership.

### New Owner Reported

When a vehicle is sold to a new owner, the Title must be transferred to the new owner(s) at a Department of Motor Vehicles.

### Ownership History

CARFAX defines an owner as an individual or business that possesses and uses a vehicle. Not all title transactions represent changes in ownership. To provide estimated number of owners, CARFAX proprietary technology analyzes all the events in a vehicle history. Estimated ownership is available for vehicles manufactured after 1991 and titled solely in the US including Puerto Rico. Dealers sometimes opt to take ownership of a vehicle and are required to in the following states: Maine, Massachusetts, New Jersey, Ohio, Oklahoma, Pennsylvania and South Dakota. Please consider this as you review a vehicle's estimated ownership history.

### Title Issued

A state issues a title to provide a vehicle owner with proof of ownership. Each title has a unique number. Each title or registration record on a CARFAX report does not necessarily indicate a change in ownership. In Canada, a registration and bill of sale are used as proof of ownership.

Follow Us:



[facebook.com/CARFAX](https://www.facebook.com/CARFAX)



[@CARFAXinc](https://twitter.com/CARFAXinc)



[About CARFAX](#)

CARFAX DEPENDS ON ITS SOURCES FOR THE ACCURACY AND RELIABILITY OF ITS INFORMATION. THEREFORE, NO RESPONSIBILITY IS ASSUMED BY CARFAX OR ITS AGENTS FOR ERRORS OR OMISSIONS IN THIS REPORT. CARFAX FURTHER EXPRESSLY DISCLAIMS ALL WARRANTIES, EXPRESS OR IMPLIED, INCLUDING ANY IMPLIED WARRANTIES OF MERCHANTABILITY OR FITNESS FOR A PARTICULAR PURPOSE.

© 2024 CARFAX, Inc., part of S&P Global. All rights reserved.  
11/8/24 2:55:36 PM (CST)

**I have reviewed and received a copy of the CARFAX Vehicle History Report for this 2010 SUBARU OUTBACK vehicle (VIN: 4S4BRCKC7A3372180), which is based on information supplied to CARFAX and available as of 11/8/24 at 3:55 PM (EST).**

---

**Customer Signature**

**Date**

---

**Dealer Signature**

**Date**