



# Report

US \$44.99

## 2010 Acura RDX W/Tech

158,600 mi | VIN: 5J8TB2H5XAA004105 |

4 Door Wagon/Sport Utility | 2.3L I4 F DOHC 16V | Gasoline | Front wheel drive

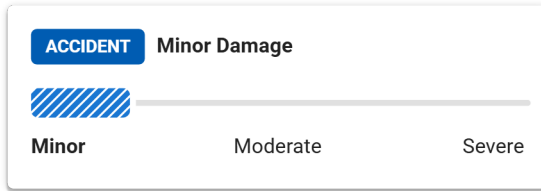

**CARFAX VALUE** \$6,110



16 Service history records

2 Previous owners

Personal vehicle

Last owned in Georgia

53 Detailed records available

This CARFAX Vehicle History Report is based only on information supplied to CARFAX and available as of 4/1/26 at 6:29:18 PM (CDT). Other information about this vehicle, including problems, may not have been reported to CARFAX. Use this report as one important tool, along with a vehicle inspection and test drive, to make a better decision about your next used car.



## Accident / Damage History

Not all accidents / issues are reported to CARFAX

### Event 1

09/29/2014

#### Accident reported: minor damage

- Vehicle involved in a rear-end collision
- Functional damage reported
- Airbags did not deploy

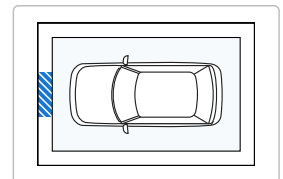
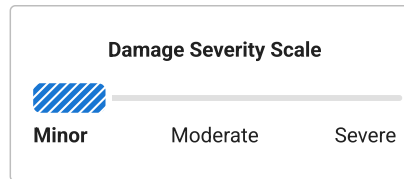

### Event 2

06/06/2023

#### Accident reported: minor damage

- Vehicle involved in a sideswipe collision
- Airbags did not deploy

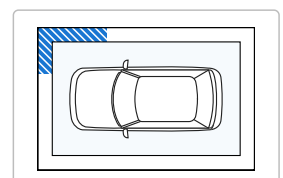
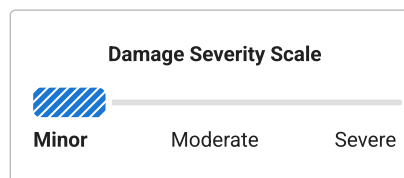









## History-Based Value Report

# \$6,110

CARFAX Retail Value

### History events affecting this vehicle's value

-   Service History
-   Personal Vehicle
-   Minor Damage



## Reliability Forecast

Based on 2010 Acura RDX W/Tech with similar mileage



### 3-Year Reliability Forecast



Good news! This vehicle is expected to have average risk of repair and average repair costs.





### What makes this vehicle have good reliability?

-  **Top 50%** compared to similar vehicles
-  **Average Repair Cost**  
\$550 avg per year
-  **Average Likelihood of Repair**



## Additional History



Not all accidents / issues are reported to CARFAX

	 Owner 1	 Owner 2
<b>Total Loss</b> No total loss reported to CARFAX.	<input checked="" type="checkbox"/> No Issues Reported	<input checked="" type="checkbox"/> No Issues Reported
<b>Structural Damage</b> CARFAX recommends that you have this vehicle inspected by a collision repair specialist.	<input checked="" type="checkbox"/> No Issues Reported	<input checked="" type="checkbox"/> No Issues Reported
<b>Airbag Deployment</b> No airbag deployment reported to CARFAX.	<input checked="" type="checkbox"/> No Issues Reported	<input checked="" type="checkbox"/> No Issues Reported
<b>Odometer Check</b> No indication of an odometer rollback.	<input checked="" type="checkbox"/> No Issues Indicated	<input checked="" type="checkbox"/> No Issues Indicated
<b>Accident / Damage</b> Accidents reported: 09/29/2014 and 06/06/2023.	<input checked="" type="checkbox"/> No Issues Reported	Minor Damage
<b>Manufacturer Recall</b> No open recalls reported to CARFAX.	<input checked="" type="checkbox"/> No Recalls Reported	<input checked="" type="checkbox"/> No Recalls Reported
<b>Basic Warranty</b> Original warranty estimated to have expired.	Warranty Expired	Warranty Expired



## Title History

CARFAX guarantees the information in this section

	 Owner 1	 Owner 2
<b>Damage Brands</b> Salvage   Junk   Rebuilt   Fire   Flood   Hail   Lemon	<input checked="" type="checkbox"/> <b>Guaranteed</b> No Problem	<input checked="" type="checkbox"/> <b>Guaranteed</b> No Problem
<b>Odometer Brands</b> Not Actual Mileage   Exceeds Mechanical Limits	<input checked="" type="checkbox"/> <b>Guaranteed</b> No Problem	<input checked="" type="checkbox"/> <b>Guaranteed</b> No Problem



**GUARANTEED** - None of these title problems were reported by a U.S. state Department of Motor Vehicles (DMV). If you find that any of these title problems were reported by a DMV and not included in this report, you may qualify. [View Terms](#) | [View Certificate](#)



## Ownership History

The number of owners is estimated

	Owner 1	Owner 2
Year purchased	2010	2014
Type of owner	Personal	Personal
Estimated length of ownership	3 yrs. 11 mo.	11 yrs. 11 mo.
Owned in the following states/provinces	New Jersey, Texas	Georgia
Estimated miles driven per year	10,815/yr	10,270/yr
Last reported odometer reading	42,787	158,600



## Detailed History





**Owner 1**

Purchased: 2010







**Low mileage!** This owner drove less than the industry average of 15,000 miles per year.

Personal Vehicle  
10,815 mi/yr

Date	Mileage	Source	Comments
04/28/2010	5	Bill Vince's Bridgewater Acura Bridgewater, NJ 908-704-0300 bridgewateracura.com ★ 4.7 / 5.0 891 Verified Reviews ♥ 8,891 Customer Favorites	<b>Vehicle sold</b>
04/28/2010	10	Bill Vince's Bridgewater Acura Bridgewater, NJ 908-704-0300 bridgewateracura.com ★ 4.7 / 5.0 891 Verified Reviews ♥ 8,891 Customer Favorites	 <b>Vehicle serviced</b> - Pre-delivery inspection completed - Vehicle washed/detailed
05/03/2010		New Jersey Motor Vehicle Dept. Watchung, NJ Title #RV20101230670	<b>Title issued or updated</b> - Registration issued or renewed - First owner reported - Titled or registered as personal vehicle - Vehicle color noted as Red
09/07/2010	4,985	Mac Churchill Acura Fort Worth, TX 817-232-2872 macchurchill.com ★ 4.0 / 5.0 77 Verified Reviews	 <b>Vehicle serviced</b> - Maintenance inspection completed - A/C and heating system checked - A/C refrigerant recharged - Battery/charging system checked - Electrical system checked - Front door latch replaced - Oil and filter changed - Steering/suspension checked - Vehicle washed/detailed
10/08/2010	5,535	Texas Motor Vehicle Dept. Roanoke, TX Title #06130640449132237	<b>Title issued or updated</b> - Registration updated when owner moved the vehicle to a new location
05/03/2011	10,060	Mac Churchill Acura Fort Worth, TX 817-232-2872 macchurchill.com ★ 4.0 / 5.0 77 Verified Reviews	 <b>Vehicle serviced</b> - Maintenance inspection completed - Oil and filter changed - Vehicle washed/detailed
09/01/2011		Texas Motor Vehicle Dept. Roanoke, TX	<b>Registration issued or renewed</b> - Passed safety inspection - Vehicle color noted as Maroon

Title #06130640449132237

11/15/2011	15,797	Mac Churchill Acura Fort Worth, TX 817-232-2872 macchurchill.com ★ 4.0 / 5.0 77 Verified Reviews		<b>Vehicle serviced</b> - Maintenance inspection completed - Recommended maintenance performed - Cabin air filter replaced/cleaned - Oil and filter changed - Rear differential fluid flushed/changed - Steering/suspension checked - Tire condition and pressure checked - Tires rotated - Vehicle washed/detailed
08/08/2012	28,121	Texas Inspection Station Roanoke, TX		<b>Passed emissions inspection</b>
09/01/2012		Texas Motor Vehicle Dept. Roanoke, TX Title #06130640449132237		<b>Registration issued or renewed</b> - Passed safety inspection - Vehicle color noted as Maroon
08/19/2013	38,442	Texas Inspection Station Roanoke, TX		<b>Passed emissions inspection</b>
09/01/2013		Texas Motor Vehicle Dept. Roanoke, TX Title #06130640449132237		<b>Registration issued or renewed</b> - Passed safety inspection - Vehicle color noted as Maroon
09/02/2013		National Tire & Battery Roanoke, TX 682-831-0500 ntb.com ★ 4.5 / 5.0 58 Verified Reviews ❤️ 38 Customer Favorites		<b>Vehicle serviced</b> - Oil and filter changed
01/25/2014		National Tire & Battery Roanoke, TX 682-831-0500 ntb.com ★ 4.5 / 5.0 58 Verified Reviews ❤️ 38 Customer Favorites		<b>Vehicle serviced</b> - Battery replaced
04/14/2014		Georgia Motor Vehicle Dept.		<b>Vehicle purchase reported</b>
04/16/2014	42,787	Georgia Inspection Station		<b>Passed emissions inspection</b>

 **Owner 2**  
Purchased: 2014



**Low mileage!** This owner drove less than the industry average of 15,000 miles per year.

Personal Vehicle  
10,270 mi/yr

Date	Mileage	Source	Comments
04/21/2014	44,157	Georgia Motor Vehicle Dept. Roswell, GA Title #775154141112001	<b>Vehicle purchase reported</b> - Title issued or updated - Registration issued or renewed - New owner reported - Vehicle color noted as Maroon
09/29/2014		Damage Report	<b>Accident reported: minor damage</b> - Vehicle involved in a rear-end collision - Damage to front - Functional damage reported - Airbags did not deploy



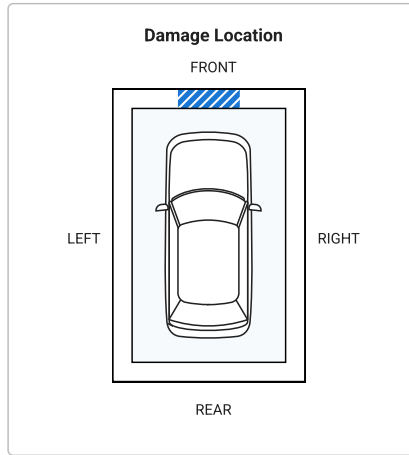
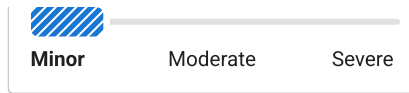

Damage Severity Scale

**CARFAX HAS THE MOST ACCIDENT & DAMAGE INFORMATION**



Minor damage is usually cosmetic, including dents or scratches to the vehicle body.

05/16/2015	54,107	Georgia Inspection Station		<b>Passed emissions inspection</b>
05/18/2015		Georgia Motor Vehicle Dept. Roswell, GA Title #775154141112001		<b>Registration issued or renewed</b> - Vehicle color noted as Maroon
04/21/2016	68,004	Jackson Acura Roswell, GA 770-650-4000 jacksonacura.com ★ <b>4.8 / 5.0</b> 634 Verified Reviews ♥ <b>1,274</b> Customer Favorites		<b>Vehicle serviced</b> - Oil and filter changed
05/26/2016	69,923	Georgia Inspection Station		<b>Passed emissions inspection</b>
05/26/2016		Georgia Motor Vehicle Dept. Roswell, GA Title #775154141112001		<b>Registration issued or renewed</b> - Vehicle color noted as Maroon
08/30/2016	74,037	Service Facility ★ <b>4.7 / 5.0</b> 18 Verified Reviews		<b>Vehicle serviced</b> - Tire(s) replaced
09/02/2016	74,187	Jackson Acura Roswell, GA 770-650-4000 jacksonacura.com ★ <b>4.8 / 5.0</b> 634 Verified Reviews ♥ <b>1,274</b> Customer Favorites		<b>Vehicle serviced</b> - Maintenance inspection completed - Air filter replaced - Battery replaced - Cabin air filter replaced/cleaned
10/12/2016	76,251	Jackson Acura Roswell, GA 770-650-4000 jacksonacura.com ★ <b>4.8 / 5.0</b> 634 Verified Reviews ♥ <b>1,274</b> Customer Favorites		<b>Vehicle serviced</b> - Brakes checked - Brake fluid flushed/changed - Rear brakes replaced - Wiper(s) replaced - Vehicle washed/detailed
04/15/2017	83,765	Georgia Inspection Station		<b>Passed emissions inspection</b>
04/26/2017		Georgia Motor Vehicle Dept.		<b>Registration issued or renewed</b> - Vehicle color noted as Maroon

		Roswell, GA Title #775154141112001		
05/27/2017	85,822	Service Facility ★ 4.7 / 5.0 18 Verified Reviews		<b>Vehicle serviced</b> - Tire repaired
09/08/2017	89,400	Service Facility ★ 4.7 / 5.0 18 Verified Reviews		<b>Vehicle serviced</b> - Tire(s) balanced - Tires rotated
05/03/2018	98,312	Georgia Inspection Station		<b>Passed emissions inspection</b>
05/08/2018		Georgia Motor Vehicle Dept. Roswell, GA Title #775154141112001		<b>Registration issued or renewed</b> - Vehicle color noted as Maroon
03/30/2019	109,092	Georgia Inspection Station		<b>Passed emissions inspection</b>
04/07/2019		Georgia Motor Vehicle Dept. Roswell, GA Title #775154141112001		<b>Registration issued or renewed</b> - Vehicle color noted as Maroon
10/23/2019	116,933	Sam's Club Tire & Battery Center Alpharetta, GA 770-992-4568 <a href="https://www.samsclub.com">https://www.samsclub.com</a> ★ 4.7 / 5.0 18 Verified Reviews		<b>Vehicle serviced</b> - Tire(s) balanced - Tires rotated
04/27/2020	122,177	Georgia Inspection Station		<b>Passed emissions inspection</b>
04/29/2020		Georgia Motor Vehicle Dept. Roswell, GA Title #775154141112001		<b>Title or registration issued</b> - Vehicle color noted as Maroon
02/12/2021	138,120	Sam's Club Tire & Battery Center Alpharetta, GA 770-992-4568 <a href="https://www.samsclub.com">https://www.samsclub.com</a> ★ 4.7 / 5.0 18 Verified Reviews		<b>Vehicle serviced</b> - Tire(s) replaced
05/18/2021		Georgia Inspection Station		<b>Passed emissions inspection</b>
05/24/2021		Georgia Motor Vehicle Dept. Roswell, GA Title #775154141112001		<b>Registration issued or renewed</b> - Vehicle color noted as Maroon
03/12/2022	142,851	Jackson Acura Roswell, GA 770-650-4000 jacksonacura.com ★ 4.8 / 5.0 634 Verified Reviews ❤️ 1,274 Customer Favorites		<b>Vehicle serviced</b> - Maintenance inspection completed - Engine oil filter adapter gasket replaced - Oil and filter changed
04/23/2022	144,950	Georgia Inspection Station		<b>Passed emissions inspection</b>
04/27/2022		Georgia Motor Vehicle Dept. Roswell, GA Title #775154141112001		<b>Registration issued or renewed</b> - Vehicle color noted as Maroon
05/13/2023	152,759	Georgia Inspection Station		<b>Passed emissions inspection</b>
05/15/2023		Georgia		<b>Registration issued or renewed</b>

Motor Vehicle Dept.  
Roswell, GA  
Title #775154141112001

- Vehicle color noted as Maroon

06/06/2023

Damage Report

**Accident reported: minor damage**  
- Vehicle involved in a sideswipe collision  
- Damage to right front  
- Airbags did not deploy

**CARFAX HAS THE MOST  
ACCIDENT & DAMAGE  
INFORMATION**

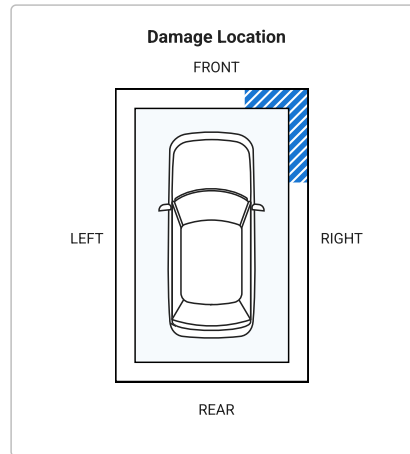
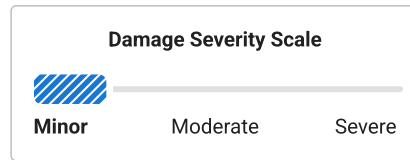

Minor damage is usually cosmetic, including dents or scratches to the vehicle body.

09/14/2023

154,613

Express Oil Change & Tire  
Engineers  
Roswell, GA  
770-642-0133



**Vehicle serviced**

- Maintenance inspection completed  
- Oil and filter changed

★ **4.8 / 5.0** 124 Verified Reviews

♥ **6** Customer Favorites

04/20/2024

157,110

Georgia  
Inspection Station

**Passed emissions inspection**

05/09/2024

Georgia  
Motor Vehicle Dept.  
Roswell, GA  
Title #775154141112001

**Registration issued or renewed**

- Vehicle color noted as Maroon

06/09/2025

158,600

Georgia  
Inspection Station

**Passed emissions inspection**

06/11/2025

Georgia  
Motor Vehicle Dept.  
Roswell, GA  
Title #775154141112001

**Registration issued or renewed**

- Vehicle color noted as Maroon

03/04/2026

Georgia  
Motor Vehicle Dept.

**Vehicle purchase reported**

03/09/2026

Georgia  
Motor Vehicle Dept.  
Roswell, GA  
Title #770266294324001

**Title issued or updated**

- Correction to record  
- Vehicle color noted as Maroon

Have Questions? Consumers, please visit our Help Center at [www.carfax.com](http://www.carfax.com). Dealers or Subscribers, please visit our Help Center at [www.carfaxonline.com](http://www.carfaxonline.com).



**Accident Indicator**

CARFAX receives information about accidents in all 50 states, the District of Columbia and Canada.

Not every accident is reported to CARFAX. As details about the accident become available, those additional details are added to the CARFAX Vehicle History Report. CARFAX recommends that you have this vehicle inspected by a qualified mechanic.

- According to the National Safety Council, Injury Facts, 2021 edition, 5% of the 276 million registered vehicles in the U.S. were involved in an accident in 2019. Over 77% of these were considered minor or moderate.
- This CARFAX Vehicle History Report is based only on information supplied to CARFAX and available as of 4/1/26 at 6:29:18 PM (CDT). Other information about this vehicle, including problems, may not have been reported to CARFAX. Use this report as one important tool, along with a vehicle inspection and test drive, to make a better decision about your next used car.

**Damage Severity**

Damage events result in one of the following severity levels:

- Minor: Generally, minor damage is cosmetic (including dents or scratches), may only require reconditioning, and typically does not compromise a vehicle's operation and/or safety.
- Moderate: Moderate damage may affect multiple components of the vehicle and may impair the vehicle's operation and/or safety.
- Severe: Severe damage usually affects multiple components of the vehicle and is likely to compromise the vehicle's operation and/or safety.

CARFAX recommends getting a pre-purchase inspection at a certified collision repair facility.

**First Owner**

When the first owner(s) obtains a title from a Department of Motor Vehicles as proof of ownership.

**New Owner Reported**

When a vehicle is sold to a new owner, the Title must be transferred to the new owner(s) at a Department of Motor Vehicles.

**Ownership History**

CARFAX defines an owner as an individual or business that possesses and uses a vehicle. Not all title transactions represent changes in ownership. To provide estimated number of owners, CARFAX proprietary technology analyzes all the events in a vehicle history. Estimated ownership is available for vehicles manufactured after 1991 and titled solely in the US including Puerto Rico. Dealers sometimes opt to take ownership of a vehicle and are required to in the following states: Maine, Massachusetts, New Jersey, Ohio, Oklahoma, Pennsylvania and South Dakota. Please consider this as you review a vehicle's estimated ownership history.

**Reliability Forecast**

The CARFAX 3-Year Reliability Forecast predicts the likelihood of repairs for a vehicle over the next three years. This forecast is based on vehicles of the same year, make, and model with similar mileage, damage, service history, and other factors, and assumes an average of 15,000 miles driven per year. Repairs are separate from regular maintenance, such as oil changes. Some of the repairs predicted may be covered under warranty. The 3-Year Reliability Forecast is based on data reported to Carfax and is only a prediction, not a guarantee.

**Title Issued**

A state issues a title to provide a vehicle owner with proof of ownership. Each title has a unique number. Each title or registration record on a CARFAX report does not necessarily indicate a change in ownership. In Canada, a registration and bill of sale are used as proof of ownership.

Follow Us: [facebook.com/CARFAX](https://facebook.com/CARFAX) [@CARFAXinc](https://twitter.com/CARFAXinc) [About CARFAX](#)

CARFAX DEPENDS ON ITS SOURCES FOR THE ACCURACY AND RELIABILITY OF ITS INFORMATION. THEREFORE, NO RESPONSIBILITY IS ASSUMED BY CARFAX OR ITS AGENTS FOR ERRORS OR OMISSIONS IN THIS REPORT. CARFAX FURTHER EXPRESSLY DISCLAIMS ALL WARRANTIES, EXPRESS OR IMPLIED, INCLUDING ANY IMPLIED WARRANTIES OF MERCHANTABILITY OR FITNESS FOR A PARTICULAR PURPOSE.

© 2026 CARFAX, Inc., part of S&P Global. All rights reserved.  
4/1/26 6:29:18 PM (CDT)

**I have reviewed and received a copy of the CARFAX Vehicle History Report for this 2010 ACURA RDX vehicle (VIN: 5J8TB2H5XAA004105), which is based on information supplied to CARFAX and available as of 4/1/26 at 7:29 PM (EDT).**

\_\_\_\_\_  
Customer Signature

\_\_\_\_\_  
Date

\_\_\_\_\_  
Dealer Signature

\_\_\_\_\_  
Date