



# Report

US \$44.99

## 2010 Mini Cooper S

97,462 mi | VIN: WMWMF7C57ATX44000

Hatchback 2 DR | 1.6L I4 F DOHC 16V | Gasoline | Front wheel drive

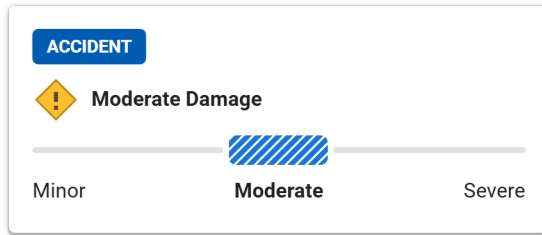

13 Service History Records

At Least 1 Open Recall

2 Previous Owners

Personal Vehicle

Last Owned in Michigan

This CARFAX Vehicle History Report is based only on information supplied to CARFAX and available as of 6/8/26 at 9:02:03 AM (CDT). Other information about this vehicle, including problems, may not have been reported to CARFAX. Use this report as one important tool, along with a vehicle inspection and test drive, to make a better decision about your next used car.



## Accident / Damage History

Not all accidents / issues are reported to CARFAX

### Event 1

10/18/2013

**Accident reported: moderate damage with another motor vehicle**

- Airbags did not deploy

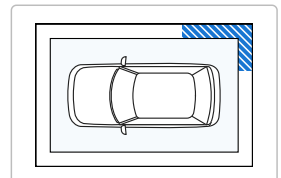
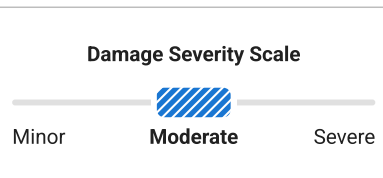





### Event 2



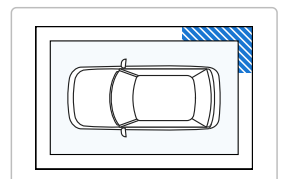
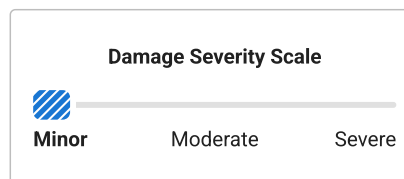

12/07/2013



**Accident reported: very minor damage**



- It hit a parked motor vehicle  
- Airbags did not deploy











|  <b>Additional History</b><br>Not all accidents / issues are reported to CARFAX |  <b>Owner 1</b> |  <b>Owner 2</b> |
|---|--|--|
| <b>Total Loss</b><br>No total loss reported to CARFAX.  | <input checked="" type="checkbox"/> No Issues Reported   | <input checked="" type="checkbox"/> No Issues Reported   |
| <b>Structural Damage</b><br>CARFAX recommends that you have this vehicle inspected by a collision repair specialist.  | <input checked="" type="checkbox"/> No Issues Reported   | <input checked="" type="checkbox"/> No Issues Reported   |
| <b>Airbag Deployment</b><br>No airbag deployment reported to CARFAX.  | <input checked="" type="checkbox"/> No Issues Reported   | <input checked="" type="checkbox"/> No Issues Reported   |
| <b>Odometer Check</b><br>No indication of an odometer rollback.   | <input checked="" type="checkbox"/> No Issues Indicated  | <input checked="" type="checkbox"/> No Issues Indicated  |
| <b>Accident / Damage</b><br>Accidents reported: 10/18/2013 and 12/07/2013.  | <input checked="" type="checkbox"/> No Issues Reported   | Accident Reported  |
| <b>Manufacturer Recall</b><br>At least 1 manufacturer recall requires service. Locate an authorized Mini dealer near you to schedule an appointment.            | <input checked="" type="checkbox"/> No Recalls Reported  | Recall Reported  |
| <b>Basic Warranty</b><br>Original warranty estimated to have expired.   | <b>Warranty Expired</b>  | <b>Warranty Expired</b>  |

|  <b>Title History</b><br>CARFAX guarantees the information in this section  |  <b>Owner 1</b> |  <b>Owner 2</b> |
|--|--|--|
| <b>Damage Brands</b><br>Salvage   Junk   Rebuilt   Fire   Flood   Hail   Lemon   | <input checked="" type="checkbox"/> <b>Guaranteed</b><br>No Problem                                | <input checked="" type="checkbox"/> <b>Guaranteed</b><br>No Problem                                |
| <b>Odometer Brands</b><br>Not Actual Mileage   Exceeds Mechanical Limits   | <input checked="" type="checkbox"/> <b>Guaranteed</b><br>No Problem                                | <input checked="" type="checkbox"/> <b>Guaranteed</b><br>No Problem                                |
|  <b>GUARANTEED</b> - None of these title problems were reported by a U.S. state Department of Motor Vehicles (DMV). If you find that any of these title problems were reported by a DMV and not included in this report, you may qualify.<br><a href="#">View Terms</a>   <a href="#">View Certificate</a> |  |  |





|  <b>Ownership History</b><br>The number of owners is estimated |  <b>Owner 1</b> |  <b>Owner 2</b> |
|---|--|--|
| Year purchased  | 2010   | 2012   |
| Type of owner   | Personal   | Personal   |
| Estimated length of ownership   | 2 yrs. 1 mo.   | 13 yrs. 10 mo.   |
| Owned in the following states/provinces   | Michigan   | Michigan   |
| Estimated miles driven per year   | 19,554/yr  | 12,589/yr  |
| Last reported odometer reading  | 42,191   | 97,462   |

|  <b>Detailed History</b>           |         |  |                     |
|---|---------|--|---------------------|
|  <b>Owner 1</b><br>Purchased: 2010 |         | Personal Vehicle<br>19,554 mi/yr   |                     |
| Date  | Mileage | Source   | Comments            |
| 03/31/2010  |         | The Sharpe Collection<br>Grand Rapids, MI<br>616-452-5101<br>thesharpecollection.com<br>★ <b>4.8 / 5.0</b> 193 Verified Reviews<br>♥ <b>6,022</b> Customer Favorites | <b>Vehicle sold</b> |

|            |        |   |   |   |
|------------|--------|---|---|---|
| 03/31/2010 | 1      | <p>Sharpe BMW-MINI<br/>Grand Rapids, MI<br/>616-452-5101<br/>sharpebmw.com</p> <p>★ <b>4.8 / 5.0</b> 193 Verified Reviews<br/>♥ <b>6,022</b> Customer Favorites</p>                 |     | <b>Vehicle serviced</b>   |
| 03/31/2010 | 5      | <p>Michigan<br/>Motor Vehicle Dept.<br/>Zeeland, MI<br/>Title #603Y0901904</p>  |   | <b>Title or registration issued</b><br>- First owner reported<br>- Titled or registered as personal vehicle   |
| 09/17/2010 | 13,670 | <p>Sharpe BMW-MINI<br/>Grand Rapids, MI<br/>616-452-5101<br/>sharpebmw.com</p> <p>★ <b>4.8 / 5.0</b> 193 Verified Reviews<br/>♥ <b>6,022</b> Customer Favorites</p>                 |    | <b>Vehicle serviced</b><br>- Vehicle washed/detailed  |
| 10/15/2010 |        | <p>Michigan<br/>Motor Vehicle Dept.<br/>Zeeland, MI</p>   |   | <b>Registration issued or renewed</b>   |
| 12/03/2010 | 17,394 | <p>Sharpe BMW-MINI<br/>Grand Rapids, MI<br/>616-452-5101<br/>sharpebmw.com</p> <p>★ <b>4.8 / 5.0</b> 193 Verified Reviews<br/>♥ <b>6,022</b> Customer Favorites</p>                 |    | <b>Vehicle serviced</b><br>- Clutch replaced  |
| 02/14/2011 | 20,536 | <p>Sharpe BMW-MINI<br/>Grand Rapids, MI<br/>616-452-5101<br/>sharpebmw.com</p> <p>★ <b>4.8 / 5.0</b> 193 Verified Reviews<br/>♥ <b>6,022</b> Customer Favorites</p>                 |    | <b>Vehicle serviced</b><br>- Maintenance inspection completed<br>- Oil and filter changed<br>- Tire(s) balanced<br>- Tires rotated  |
| 09/08/2011 | 30,387 | <p>Sharpe BMW-MINI<br/>Grand Rapids, MI<br/>616-452-5101<br/>sharpebmw.com</p> <p>★ <b>4.8 / 5.0</b> 193 Verified Reviews<br/>♥ <b>6,022</b> Customer Favorites</p>                 |  | <b>Vehicle serviced</b><br>- Maintenance inspection completed<br>- Body electrical system checked<br>- Fluids checked   |
| 10/26/2011 |        | <p>Michigan<br/>Motor Vehicle Dept.<br/>Fennville, MI</p>   |   | <b>Registration issued or renewed</b><br>- Registration updated when owner moved the vehicle to a new location  |
| 03/19/2012 | 38,996 | <p>Sharpe BMW-MINI<br/>Grand Rapids, MI<br/>616-452-5101<br/>sharpebmw.com</p> <p>★ <b>4.8 / 5.0</b> 193 Verified Reviews<br/>♥ <b>6,022</b> Customer Favorites</p>                 |  | <b>Vehicle serviced</b><br>- Brake fluid flushed/changed<br>- Cabin air filter replaced/cleaned<br>- Drivability/performance checked<br>- Fluids checked<br>- Tire condition and pressure checked |
| 05/15/2012 | 41,567 | <p>Sharpe BMW-MINI<br/>Grand Rapids, MI<br/>616-452-5101<br/>sharpebmw.com</p> <p>★ <b>4.8 / 5.0</b> 193 Verified Reviews<br/>♥ <b>6,022</b> Customer Favorites</p>                 |  | <b>Vehicle serviced</b><br>- Maintenance inspection completed<br>- Oil and filter changed   |
| 05/24/2012 | 42,055 | <p>The Sharpe Collection<br/>Grand Rapids, MI<br/>616-452-5101<br/>thesharpecollection.com</p> <p>★ <b>4.8 / 5.0</b> 193 Verified Reviews<br/>♥ <b>6,022</b> Customer Favorites</p> |   | <b>Vehicle offered for sale</b>   |

|            |        |  |  |
|------------|--------|--|--|
| 05/31/2012 | 42,067 | Sharpe BMW-MINI<br>Grand Rapids, MI<br>616-452-5101<br>sharpebmw.com<br>★ 4.8 / 5.0 193 Verified Reviews<br>♥ 6,022 Customer Favorites                 | <b>Odometer reading reported</b>   |
| 07/30/2012 | 42,191 | The Sharpe Collection<br>Grand Rapids, MI<br>616-452-5101<br>thesharpecollection.com<br>★ 4.8 / 5.0 193 Verified Reviews<br>♥ 6,022 Customer Favorites | <b>Vehicle sold</b>  |
| 07/31/2012 |        | Sharpe BMW-MINI<br>Grand Rapids, MI<br>616-452-5101<br>sharpebmw.com<br>★ 4.8 / 5.0 193 Verified Reviews<br>♥ 6,022 Customer Favorites                 |  <b>Vehicle serviced</b><br>- Vehicle washed/detailed |

 **Owner 2** Personal Vehicle  
Purchased: 2012 12,589 mi/yr

| Date       | Mileage | Source   | Comments   |
|------------|---------|--|--|
| 07/31/2012 |         | Michigan<br>Motor Vehicle Dept.<br>Kalamazoo, MI<br>Title #603A2131835   | <b>Title or registration issued</b><br>- New owner reported  |
| 08/01/2012 |         | Michigan<br>Motor Vehicle Dept.<br>Kalamazoo, MI<br>Title #263A2140262   | <b>Title or registration issued</b>  |
| 03/11/2013 | 47,344  | Sharpe BMW-MINI<br>Grand Rapids, MI<br>616-452-5101<br>sharpebmw.com<br>★ 4.8 / 5.0 193 Verified Reviews<br>♥ 6,022 Customer Favorites |  <b>Vehicle serviced</b><br>- Maintenance inspection completed  |
| 04/08/2013 |         | Michigan<br>Motor Vehicle Dept.<br>Kalamazoo, MI   | <b>Registration issued or renewed</b>  |
| 08/23/2013 | 52,914  | The Muffler Shop<br>Houghton, MI<br>906-482-3773<br>themufflershop.net<br>★ 4.7 / 5.0 39 Verified Reviews<br>♥ 51 Customer Favorites   |  <b>Vehicle serviced</b><br>- Engine checked  |
| 08/30/2013 | 53,179  | MINI of the Fox Valley<br>Appleton, WI<br>920-968-6464<br>bergstromauto.com<br>★ 4.8 / 5.0 19 Verified Reviews                         |  <b>Vehicle serviced</b><br>- Timing belt/chain replaced<br>- Timing chain replaced   |
| 09/02/2013 |         | Michigan<br>Motor Vehicle Dept.<br>Kalamazoo, MI   | <b>Registration issued or renewed</b>  |
| 10/18/2013 |         | Damage Report  |  <b>Accident reported: moderate damage with another motor vehicle</b><br>- Damage to right rear<br>- Airbags did not deploy |

**CARFAX HAS THE MOST ACCIDENT & DAMAGE INFORMATION**

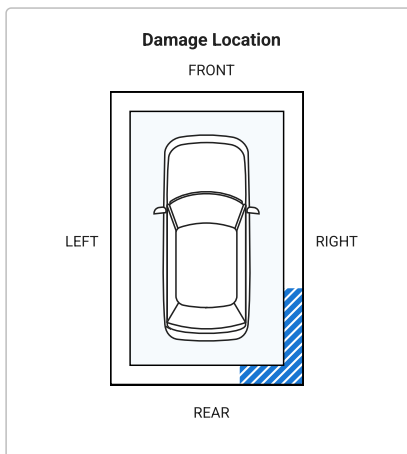
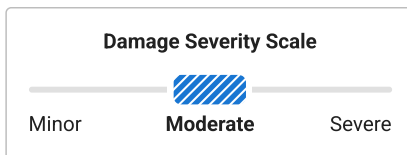

12/07/2013

Damage Report

**Accident reported: very minor damage**

- It hit a parked motor vehicle
- Damage to right rear
- Airbags did not deploy

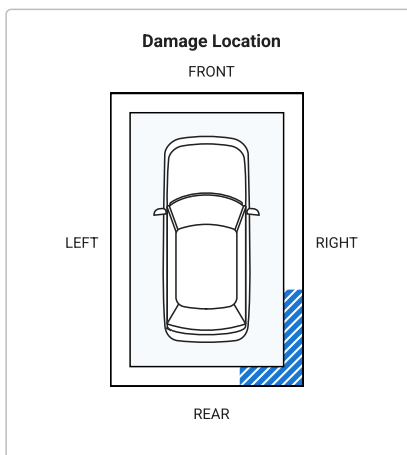
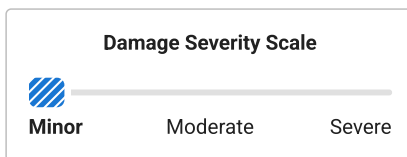

**CARFAX HAS THE MOST ACCIDENT & DAMAGE INFORMATION**

05/07/2014

59,478

Sharpe BMW-MINI  
Grand Rapids, MI  
616-452-5101  
sharpebmw.com

★ **4.8 / 5.0** 193 Verified Reviews

♥ **6,022** Customer Favorites



**Vehicle serviced**

- Maintenance inspection completed
- Brake fluid flushed/changed
- Cabin air filter replaced/cleaned
- Oil and filter changed

09/11/2014

Michigan  
Motor Vehicle Dept.  
Kalamazoo, MI

**Registration issued or renewed**

09/29/2015



Michigan  
Motor Vehicle Dept.  
Kalamazoo, MI

**Registration issued or renewed**

09/17/2016

Michigan  
Motor Vehicle Dept.  
Kalamazoo, MI

**Registration issued or renewed**

|            |        |   |  |  |
|------------|--------|---|--|--|
| 03/03/2017 | 97,462 | Lakeside Auto Sales & Service<br>Hancock, MI<br>906-482-9020<br>★ 4.9 / 5.0 21 Verified Reviews<br>♥ 4 Customer Favorites |  | <b>Vehicle serviced</b>  |
| 09/14/2017 |        | Michigan<br>Motor Vehicle Dept.<br>Kalamazoo, MI  |  | <b>Registration issued or renewed</b>  |
| 09/17/2018 |        | Michigan<br>Motor Vehicle Dept.<br>Kalamazoo, MI  |  | <b>Registration issued or renewed</b>  |
| 09/18/2019 |        | Michigan<br>Motor Vehicle Dept.<br>Kalamazoo, MI  |  | <b>Registration issued or renewed</b>  |
| 05/12/2023 |        | BMW of North<br>America, LLC  |  | <b>Manufacturer Safety recall issued</b><br>- NHTSA #23V-337<br>- Recall #23V-337:439 FOOTWELL CONTROL MODULE (FRM)<br>- Status: Remedy Available<br><br>Need more information about this recall? Find an authorized MINI dealer, email <a href="mailto:MINI.Assistance@askminiusa.com">MINI.Assistance@askminiusa.com</a> , or call 1-866-825-1525<br><br> <b>Learn more about this recall</b> |

**Description:** Due to several factors, over time, the FRM (an electronic control unit) could become susceptible to corrosion. Eventually, the corrosion could potentially result in a short circuit.

In rare cases, this could lead to a thermal event which could increase the risk of injury.

**Remedy:** The sunroof drains, interior footwell area, and FRM, will be inspected. Depending upon the results of the inspection, the necessary work, which will be performed for free by your authorized MINI dealer, could take about a day or two.

Hmm, we haven't received any information on this car since May 2023. Before you buy, ask the seller for recent service or repair records.

Have Questions? Consumers, please visit our Help Center at [www.carfax.com](http://www.carfax.com). Dealers or Subscribers, please visit our Help Center at [www.carfaxonline.com](http://www.carfaxonline.com).

## Glossary

### Accident Indicator

CARFAX receives information about accidents in all 50 states, the District of Columbia and Canada.

Not every accident is reported to CARFAX. As details about the accident become available, those additional details are added to the CARFAX Vehicle History Report. CARFAX recommends that you have this vehicle inspected by a qualified mechanic.

- According to the National Safety Council, Injury Facts, 2021 edition, 5% of the 276 million registered vehicles in the U.S. were involved in an accident in 2019. Over 77% of these were considered minor or moderate.
- This CARFAX Vehicle History Report is based only on information supplied to CARFAX and available as of 6/8/26 at 9:02:03 AM (CDT). Other information about this vehicle, including problems, may not have been reported to CARFAX. Use this report as one important tool, along with a vehicle inspection and test drive, to make a better decision about your next used car.

### Damage Severity

Damage events result in one of the following severity levels:

- Minor: Generally, minor damage is cosmetic (including dents or scratches), may only require reconditioning, and typically does not compromise a vehicle's operation and/or safety.
- Moderate: Moderate damage may affect multiple components of the vehicle and may impair the vehicle's operation and/or safety.
- Severe: Severe damage usually affects multiple components of the vehicle and is likely to compromise the vehicle's operation and/or safety.

CARFAX recommends getting a pre-purchase inspection at a certified collision repair facility.

### First Owner

When the first owner(s) obtains a title from a Department of Motor Vehicles as proof of ownership.

### Manufacturer Recall

Automobile manufacturers issue recall notices to inform vehicle owners of a safety defect or failure to meet minimum federal safety or emissions standards. Manufacturer recalls are repaired at no cost to the customer.

### New Owner Reported

When a vehicle is sold to a new owner, the Title must be transferred to the new owner(s) at a Department of Motor Vehicles.

**Ownership History**

CARFAX defines an owner as an individual or business that possesses and uses a vehicle. Not all title transactions represent changes in ownership. To provide estimated number of owners, CARFAX proprietary technology analyzes all the events in a vehicle history. Estimated ownership is available for vehicles manufactured after 1991 and titled solely in the US including Puerto Rico. Dealers sometimes opt to take ownership of a vehicle and are required to in the following states: Maine, Massachusetts, New Jersey, Ohio, Oklahoma, Pennsylvania and South Dakota. Please consider this as you review a vehicle's estimated ownership history.

Follow Us:  [facebook.com/CARFAX](https://facebook.com/CARFAX)  [@CARFAXinc](https://twitter.com/CARFAXinc)  [About CARFAX](#)

CARFAX DEPENDS ON ITS SOURCES FOR THE ACCURACY AND RELIABILITY OF ITS INFORMATION. THEREFORE, NO RESPONSIBILITY IS ASSUMED BY CARFAX OR ITS AGENTS FOR ERRORS OR OMISSIONS IN THIS REPORT. CARFAX FURTHER EXPRESSLY DISCLAIMS ALL WARRANTIES, EXPRESS OR IMPLIED, INCLUDING ANY IMPLIED WARRANTIES OF MERCHANTABILITY OR FITNESS FOR A PARTICULAR PURPOSE.

© 2026 CARFAX, Inc., part of S&P Global. All rights reserved.  
6/8/26 9:02:03 AM (CDT)

**I have reviewed and received a copy of the CARFAX Vehicle History Report for this 2010 MINI COOPER vehicle (VIN: WMWMF7C57ATX44000), which is based on information supplied to CARFAX and available as of 6/8/26 at 10:02 AM (EDT).**

\_\_\_\_\_  
Customer Signature

\_\_\_\_\_  
Date

\_\_\_\_\_  
Dealer Signature

\_\_\_\_\_  
Date