



History-Based Value Report

History events affecting this vehicle's value



Regular Oil Changes



Personal Vehicle



Accident Reported



Open Recall

\$6,720 Retail Value



Vehicle History Report™

US \$44.99

2006 BMW 3 SERIES 325XI

VIN: WBAVD13596KV07528
SEDAN 4 DR
3.0L I6 F DOHC 24V
GASOLINE
ALL WHEEL DRIVE



Accident reported



Regular oil changes



At least 1 open recall



2 Previous owners





Personal vehicle



131,708 Last reported odometer reading

This CARFAX Vehicle History Report is based only on information supplied to CARFAX and available as of 12/21/23 at 11:13:34 AM (CST). Other information about this vehicle, including problems, may not have been reported to CARFAX. Use this report as one important tool, along with a vehicle inspection and test drive, to make a better decision about your next used car.

 Ownership History The number of owners is estimated	Owner 1	Owner 2
Year purchased	2006	2020
Type of owner	Personal	Personal
Estimated length of ownership	10 yrs. 3 mo.	3 yrs. 6 mo.
Owned in the following states/provinces	See Details	North Carolina
Estimated miles driven per year	7,352/yr	10,292/yr
Last reported odometer reading	96,889	131,708

 Title History CARFAX guarantees the information in this section	Owner 1	Owner 2
Damage Brands Salvage Junk Rebuilt Fire Flood Hail Lemon	<input checked="" type="checkbox"/> Guaranteed No Problem	<input checked="" type="checkbox"/> Guaranteed No Problem
Odometer Brands Not Actual Mileage Exceeds Mechanical Limits	<input checked="" type="checkbox"/> Guaranteed No Problem	<input checked="" type="checkbox"/> Guaranteed No Problem
 GUARANTEED - None of these title problems were reported by a U.S. state Department of Motor Vehicles (DMV). If you find that any of these title problems were reported by a DMV and not included in this report, you may qualify. View Terms View Certificate		

 Additional History Not all accidents / issues are reported to CARFAX	Owner 1	Owner 2
Total Loss No total loss reported to CARFAX.	<input checked="" type="checkbox"/> No Issues Reported	<input checked="" type="checkbox"/> No Issues Reported
Structural Damage CARFAX recommends that you have this vehicle inspected by a collision repair specialist.	<input checked="" type="checkbox"/> No Issues Reported	<input checked="" type="checkbox"/> No Issues Reported
Airbag Deployment No airbag deployment reported to CARFAX.	<input checked="" type="checkbox"/> No Issues Reported	<input checked="" type="checkbox"/> No Issues Reported
Odometer Check No indication of an odometer rollback.	<input checked="" type="checkbox"/> No Issues Indicated	<input checked="" type="checkbox"/> No Issues Indicated
Accident / Damage Accidents reported: 06/18/2016, 03/02/2021, and 07/23/2021.	Accident Reported	Accident Reported

Manufacturer Recall	<input checked="" type="checkbox"/> No Recalls Reported	Recall Reported
Basic Warranty	Warranty Expired	Warranty Expired

CARFAX Detailed History







Owner 1
Purchased: 2006











Low mileage! This owner drove less than the industry average of 15,000 miles per year.







Personal Vehicle
7,352 mi/yr





Date	Mileage	Source	Comments
02/11/2006		US Customs	Vehicle exported from Germany and imported to Newark, NJ
02/18/2006		JMK BMW Springfield, NJ 973-379-7744 jmkbmw.com ★ 4.8 / 5.0 36 Verified Reviews	 Vehicle serviced Pre-delivery inspection completed Key(s) (re) programmed Floor mats installed
03/02/2006 6		New Jersey Motor Vehicle Dept. Clifton, NJ Title #DA20060610143	Title issued or updated First owner reported Titled or registered as personal vehicle Loan or lien reported
02/05/2007		New York Motor Vehicle Dept. Warwick, NY	Title issued or updated Registration issued or renewed Titled or registered as personal vehicle Loan or lien reported Passed safety inspection Registration updated when owner moved the vehicle to a new location





02/22/2007	Paul Miller Performance LLC dba Paul Miller BMW Wayne, NJ 888-494-5166 paulmiller.com ★ 4.5 / 5.0 604 Verified Reviews ❤️ 8,967 Customer Favorites		Vehicle serviced Electrical system checked Wiper(s) replaced Tire condition and pressure checked Oil and filter changed
03/07/2007	New York Motor Vehicle Dept. Warwick, NY		Title issued or updated Loan or lien reported
01/21/2008	Paul Miller Performance LLC dba Paul Miller BMW Wayne, NJ 888-494-5166 paulmiller.com ★ 4.5 / 5.0 604 Verified Reviews ❤️ 8,967 Customer Favorites		Vehicle serviced Tire condition and pressure checked Oil and filter changed Brake fluid flushed/changed
02/27/2008	Paul Miller Performance LLC dba Paul Miller BMW Wayne, NJ 888-494-5166 paulmiller.com ★ 4.5 / 5.0 604 Verified Reviews ❤️ 8,967 Customer Favorites		Vehicle serviced Cabin air filter replaced/cleaned One tire mounted One tire balanced
01/22/2009 31,740	Dawson Motors, Inc Warwick, NY 845-986-8558 dawsonmotors.com ★ 4.9 / 5.0 37 Verified Reviews ❤️ 13 Customer Favorites		Vehicle serviced Safety inspection performed Emissions inspection performed Emissions or safety inspection performed
01/22/2009	New York Inspection Station		Passed safety inspection Passed emissions inspection
01/22/2009	New York Motor Vehicle Dept. Warwick, NY		Registration issued or renewed Titled or registered as personal vehicle Passed safety inspection





02/02/2009	31,794	Orange County BMW Harriman, NY 845-782-4269 orangecountybmw.com ★ 4.8 / 5.0 155 Verified Reviews ♥ 2,461 Customer Favorites		Vehicle serviced Maintenance inspection completed
10/28/2009	38,324	Orange County BMW Harriman, NY 845-782-4269 orangecountybmw.com ★ 4.8 / 5.0 155 Verified Reviews ♥ 2,461 Customer Favorites		Vehicle serviced Floor mats installed Oil and filter changed Brake fluid flushed/changed Four wheel alignment performed Alignment performed Four tires replaced Carpet protection installed Drivability/performance checked Tire condition and pressure checked
01/30/2010	40,111	Dawson Motors, Inc Warwick, NY 845-986-8558 dawsonmotors.com ★ 4.9 / 5.0 37 Verified Reviews ♥ 13 Customer Favorites		Vehicle serviced Safety inspection performed Emissions inspection performed Emissions or safety inspection performed
01/30/2010		New York Inspection Station		Passed safety inspection Passed emissions inspection
08/18/2010	43,529	Orange County BMW Harriman, NY 845-782-4269 orangecountybmw.com ★ 4.8 / 5.0 155 Verified Reviews ♥ 2,461 Customer Favorites		Vehicle serviced Headlight(s) replaced Exterior trim checked Tire condition and pressure checked Body electrical system checked
01/27/2011		New York Motor Vehicle Dept. Warwick, NY		Registration issued or renewed Titled or registered as personal vehicle Passed safety inspection
02/22/2011	46,497	Dawson Motors, Inc Warwick, NY 845-986-8558 dawsonmotors.com ★ 4.9 / 5.0 37 Verified Reviews ♥ 13 Customer Favorites		Vehicle serviced Safety inspection performed Emissions inspection performed Emissions or safety inspection performed



02/22/2011		New York Inspection Station		Passed safety inspection Passed emissions inspection
07/06/2011	49,220	Orange County BMW Harriman, NY 845-782-4269 orangecountybmw.com ★ 4.8 / 5.0 155 Verified Reviews ❤️ 2,461 Customer Favorites		Vehicle serviced Four wheel alignment performed Alignment performed Antifreeze/coolant flushed/changed Brake fluid flushed/changed Fuel injection system flushed/serviced Oil and filter changed Cabin air filter replaced/cleaned Cooling system serviced
02/07/2012	53,095	Dawson Motors, Inc Warwick, NY 845-986-8558 dawsonmotors.com ★ 4.9 / 5.0 37 Verified Reviews ❤️ 13 Customer Favorites		Vehicle serviced Oil and filter changed Fluids checked Safety inspection performed Tire condition and pressure checked Emissions inspection performed Emissions or safety inspection performed
02/07/2012		New York Inspection Station		Passed safety inspection Passed emissions inspection
11/13/2012	58,907	Dawson Motors, Inc Warwick, NY 845-986-8558 dawsonmotors.com ★ 4.9 / 5.0 37 Verified Reviews ❤️ 13 Customer Favorites		Vehicle serviced Oil and filter changed Fluids checked
01/19/2013		New York Motor Vehicle Dept. Warwick, NY		Registration issued or renewed Titled or registered as personal vehicle Passed safety inspection
02/05/2013	60,165	Dawson Motors, Inc Warwick, NY 845-986-8558 dawsonmotors.com ★ 4.9 / 5.0 37 Verified Reviews ❤️ 13 Customer Favorites		Vehicle serviced Safety inspection performed Emissions inspection performed Emissions or safety inspection performed
02/05/2013		New York Inspection Station		Passed safety inspection Passed emissions inspection

03/15/2013	60,443	Dawson Motors, Inc Warwick, NY 845-986-8558 dawsonmotors.com ★ 4.9 / 5.0 37 Verified Reviews ❤️ 13 Customer Favorites		Vehicle serviced Engine oil/fluid leak checked Engine serviced
03/25/2013	60,585	Dawson Motors, Inc Warwick, NY 845-986-8558 dawsonmotors.com ★ 4.9 / 5.0 37 Verified Reviews ❤️ 13 Customer Favorites		Vehicle serviced Brakes serviced
07/01/2013	63,093	Dawson Motors, Inc Warwick, NY 845-986-8558 dawsonmotors.com ★ 4.9 / 5.0 37 Verified Reviews ❤️ 13 Customer Favorites		Vehicle serviced Rear brake pads replaced Rear brake rotor(s) replaced Brakes serviced Front brake rotor(s) replaced Front brake pads replaced Brake pad sensor(s) replaced Drivability/performance checked
07/22/2013	63,245	Dawson Motors, Inc Warwick, NY 845-986-8558 dawsonmotors.com ★ 4.9 / 5.0 37 Verified Reviews ❤️ 13 Customer Favorites		Vehicle serviced Battery/charging system checked Battery replaced
08/09/2013	63,593	Dawson Motors, Inc Warwick, NY 845-986-8558 dawsonmotors.com ★ 4.9 / 5.0 37 Verified Reviews ❤️ 13 Customer Favorites		Vehicle serviced Headlight bulb(s) replaced
10/29/2013	65,199	Dawson Motors, Inc Warwick, NY 845-986-8558 dawsonmotors.com ★ 4.9 / 5.0 37 Verified Reviews ❤️ 13 Customer Favorites		Vehicle serviced Fuel system cleaned/serviced Tire condition and pressure checked

02/03/2014	66,829	Dawson Motors, Inc Warwick, NY 845-986-8558 dawsonmotors.com ★ 4.9 / 5.0 37 Verified Reviews ❤️ 13 Customer Favorites		Vehicle serviced Safety inspection performed Tire condition and pressure checked Emissions inspection performed Emissions or safety inspection performed
02/03/2014		New York Inspection Station		Passed safety inspection Emissions inspection performed
07/29/2014		Dawson Motors, Inc Warwick, NY 845-986-8558 dawsonmotors.com ★ 4.9 / 5.0 37 Verified Reviews ❤️ 13 Customer Favorites		Vehicle serviced Maintenance inspection completed Oil and filter changed Fluids checked Tire condition and pressure checked
10/28/2014	70,511	Dawson Motors, Inc Warwick, NY 845-986-8558 dawsonmotors.com ★ 4.9 / 5.0 37 Verified Reviews ❤️ 13 Customer Favorites		Vehicle serviced Oil and filter changed Fluids checked Tire condition and pressure checked
01/05/2015	71,839	Dawson Motors, Inc Warwick, NY 845-986-8558 dawsonmotors.com ★ 4.9 / 5.0 37 Verified Reviews ❤️ 13 Customer Favorites		Vehicle serviced Safety inspection performed Emissions inspection performed Emissions or safety inspection performed
01/05/2015		New York Inspection Station		Passed safety inspection Passed emissions inspection
01/30/2015		New York Motor Vehicle Dept. Warwick, NY		Registration issued or renewed Titled or registered as personal vehicle Passed safety inspection
08/25/2015	73,458	Dawson Motors, Inc Warwick, NY 845-986-8558 dawsonmotors.com ★ 4.9 / 5.0 37 Verified Reviews ❤️ 13 Customer Favorites		Vehicle serviced A/C refrigerant recharged A/C system checked

11/02/2015	74,018	Dawson Motors, Inc Warwick, NY 845-986-8558 dawsonmotors.com ★ 4.9 / 5.0 37 Verified Reviews ❤️ 13 Customer Favorites		Vehicle serviced A/C refrigerant recharged A/C system checked
12/11/2015	74,162	Dawson Motors, Inc Warwick, NY 845-986-8558 dawsonmotors.com ★ 4.9 / 5.0 37 Verified Reviews ❤️ 13 Customer Favorites		Vehicle serviced A/C refrigerant recharged
01/27/2016	74,492	Dawson Motors, Inc Warwick, NY 845-986-8558 dawsonmotors.com ★ 4.9 / 5.0 37 Verified Reviews ❤️ 13 Customer Favorites		Vehicle serviced Safety inspection performed Emissions inspection performed Emissions or safety inspection performed
01/27/2016		New York Inspection Station		Passed safety inspection Passed emissions inspection
06/18/2016		Damage Report		Accident reported with another motor vehicle
06/28/2016		Tennessee Motor Vehicle Dept.		Vehicle purchase reported
06/28/2016		New York Motor Vehicle Dept. Warwick, NY		Registration issued or renewed Correction to record Titled or registered as personal vehicle Passed safety inspection
07/22/2016	76,451	Dawson Motors, Inc Warwick, NY 845-986-8558 dawsonmotors.com ★ 4.9 / 5.0 37 Verified Reviews ❤️ 13 Customer Favorites		Vehicle serviced Fluids checked Oil and filter changed Electrical system checked

07/26/2016	76,575	Paul Miller Performance LLC dba Paul Miller BMW Wayne, NJ 888-494-5166 paulmiller.com ★ 4.5 / 5.0 604 Verified Reviews ❤️ 8,967 Customer Favorites		Vehicle serviced Maintenance inspection completed
10/25/2016	77,589	Vines Auto Service Johnson City, TN 423-542-6956 vinesautoservice.com/ ★ 5.0 / 5.0 7 Verified Reviews ❤️ 7 Customer Favorites		Vehicle serviced Instrument cluster checked
11/09/2016		Tennessee Motor Vehicle Dept. Johnson City, TN Title #97697154		Title or registration issued Registration updated when owner moved the vehicle to a new location Vehicle color noted as Gray
11/03/2017		Tennessee Motor Vehicle Dept. Johnson City, TN Title #97697154		Registration issued or renewed Vehicle color noted as Gray
12/22/2017	83,465	Service Facility		Vehicle serviced Oil and filter changed
06/23/2018	86,346	Fast Track Elizabethton, TN 423-543-8975 ★ 5.0 / 5.0 104 Verified Reviews ❤️ 36 Customer Favorites		Vehicle serviced Maintenance inspection completed Oil and filter changed
11/15/2018		Tennessee Motor Vehicle Dept. Johnson City, TN Title #97697154		Registration issued or renewed Vehicle color noted as Gray
05/03/2019	90,880	Fast Track Elizabethton, TN 423-543-8975 ★ 5.0 / 5.0 104 Verified Reviews ❤️ 36 Customer Favorites		Vehicle serviced Maintenance inspection completed Oil and filter changed

07/23/2019	95,172	Rick Hill Imports Kingsport, TN 423-224-2100 rickhillimports.com ★ 4.7 / 5.0 146 Verified Reviews ❤️ 99 Customer Favorites		Vehicle serviced
10/01/2019		Tennessee Motor Vehicle Dept. Johnson City, TN Title #97697154		Registration issued or renewed Title or registration issued Vehicle color noted as Gray
10/15/2019	96,889	Service Facility		Vehicle serviced Oil and filter changed





Owner 2
Purchased: 2020



Low mileage! This owner drove less than the industry average of 15,000 miles per year.

Personal Vehicle
10,292 mi/yr

Date	Mileage	Source		Comments
06/10/2020		North Carolina Motor Vehicle Dept. Arden, NC Title #775995201620115		Registration issued or renewed Title or registration issued New owner reported
06/20/2020	99,986	Snappy Lube #37 Arden, NC 828-687-2388 ★ 4.7 / 5.0 81 Verified Reviews ❤️ 61 Customer Favorites		Vehicle serviced Maintenance inspection completed Recommended maintenance performed Oil and filter changed Fluids checked
07/21/2020	100,000	Import Auto Performance Llc Asheville, NC 828-367-0595 ★ 4.9 / 5.0 23 Verified Reviews ❤️ 37 Customer Favorites		Vehicle serviced Spark plug(s) replaced
09/26/2020	103,766	Snappy Lube #37 Arden, NC 828-687-2388 ★ 4.7 / 5.0 81 Verified Reviews ❤️ 61 Customer Favorites		Vehicle serviced Maintenance inspection completed Oil and filter changed Fluids checked

01/29/2021 108,224 Import Auto Performance Llc
 Asheville, NC
 828-367-0595
 ★ 4.9 / 5.0
 23 Verified Reviews
 ❤️ 37 Customer Favorites



Vehicle serviced

Oil and filter changed
 Upper radiator hose replaced
 Drivability/performance checked
 Thermostat replaced
 Water pump replaced

03/02/2021 Damage Report



Accident reported: very minor damage

Involving front or side impact
 Damage to left rear
 Vehicle drivable



CARFAX HAS THE MOST ACCIDENT & DAMAGE INFORMATION

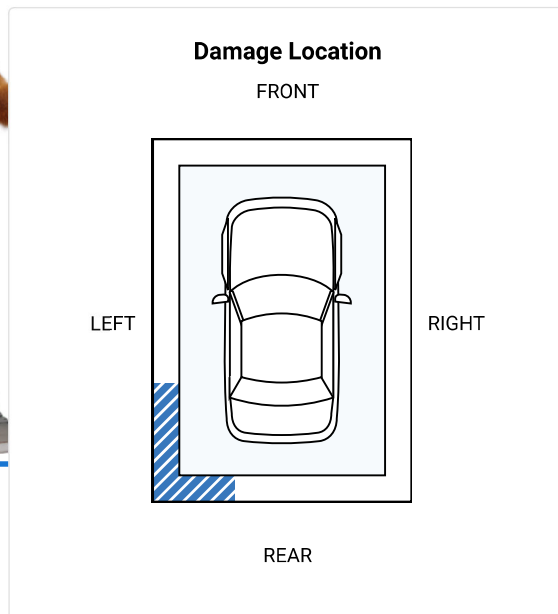
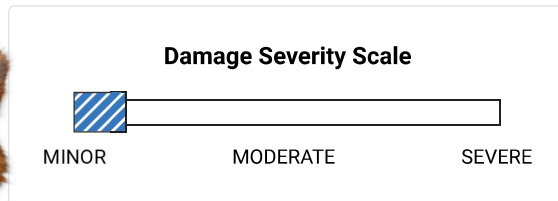

05/14/2021 113,867 Snappy Lube #37
 Arden, NC
 828-687-2388
 ★ 4.7 / 5.0
 81 Verified Reviews
 ❤️ 61 Customer Favorites



Vehicle serviced

Maintenance inspection completed
 Recommended maintenance performed
 Oil and filter changed
 Fluids checked

06/07/2021 115,143 Eurotechnik Inc.
 Hendersonville, NC
 828-698-0698
 eurotechnikselect.com
 ★ 4.9 / 5.0
 56 Verified Reviews
 ❤️ 4 Customer Favorites



Vehicle serviced

Maintenance inspection completed
 Drive belt tensioner replaced
 Drive belt(s) replaced
 Pinion seal(s) replaced
 Serpentine belt replaced
 Cabin air filter replaced/cleaned
 Cooling system hoses checked
 Radiator checked

06/24/2021 116,127 Eurotechnik Inc.
 Hendersonville, NC
 828-698-0698
 eurotechnikselect.com
 ★ 4.9 / 5.0
 56 Verified Reviews
 ❤️ 4 Customer Favorites



Vehicle serviced

A/C condenser replaced
 A/C compressor replaced
 A/C refrigerant recharged

07/23/2021 Damage Report







Accident reported: very minor damage

Vehicle involved in a rear-end collision
 Damage to front
 Vehicle towed
 Vehicle drivable
 Airbags did not deploy

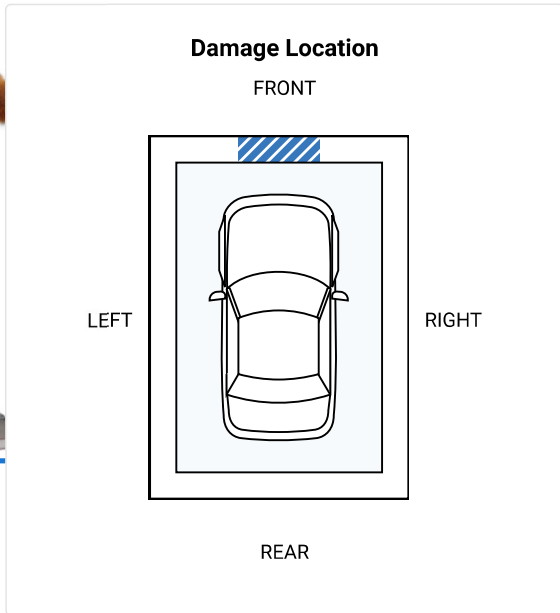
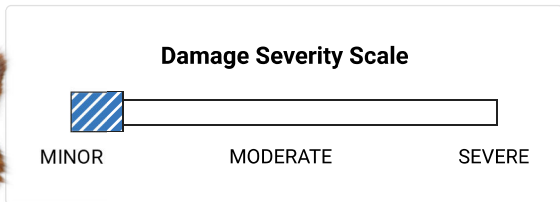

CARFAX HAS THE MOST ACCIDENT & DAMAGE INFORMATION



08/05/2021	118,965	T & J Auto Service Arden, NC 828-687-8282 ★ 4.9 / 5.0 38 Verified Reviews ❤️ 27 Customer Favorites		Vehicle serviced Front brake pads replaced Oil and filter changed Brake calipers cleaned/serviced Rear brake pads replaced Fluids checked Brake pad sensor(s) replaced Hood shocks replaced
08/12/2021		North Carolina Motor Vehicle Dept. Arden, NC Title #775995201620115		Registration issued or renewed
10/18/2021	122,447	T & J Auto Service Arden, NC 828-687-8282 ★ 4.9 / 5.0 38 Verified Reviews ❤️ 27 Customer Favorites		Vehicle serviced Fluids checked Oil and filter changed Alignment performed
11/29/2021	123,446	Bimmer Logic Arden, NC 828-214-9961 bimmerlogic.net ★ 4.9 / 5.0 35 Verified Reviews ❤️ 6 Customer Favorites		Vehicle serviced Oil line/hose replaced Intake manifold gasket(s) replaced Starter replaced Oil and filter changed
03/02/2022		BMW of North America, LLC		Manufacturer Safety recall issued NHTSA #22V-119 Recall #22V-119:407 POSITIVE CRANKCASE VENTILATION (PCV) VALVE HEATER Status: Remedy Available Need more information about this recall? Find an authorized BMW dealer, email CustomerRelations@bmwusa.com, or call 1-800-525-7417 ⊖ Learn more about this recall

Description: This recall involves an engine component known as the Positive Crankcase Ventilation (PCV) valve heater. The PCV valve heater may not have been produced to specifications which could lead to a short circuit.

Should a short circuit occur, the PCV valve heater could overheat, lead to smoldering, and possibly start melting. In extremely rare cases, this could increase the risk of a fire.

Remedy: An electrical wiring harness with fuse protection for the PCV valve heater will be installed for free. If the PCV valve heater is damaged, it will be replaced for free. This may take up to several hours to perform.

04/15/2022 127,901 T & J Auto Service
Arden, NC
828-687-8282
<https://tandjautoservice.net/arden-auto-repair-shop-location.html>

★ 4.9 / 5.0

38 Verified Reviews

♥ 27 Customer Favorites



Vehicle serviced

Oil and filter changed

07/23/2022 130,813 Valvoline Instant Oil
Change
Arden, NC
828-579-2997
vioc.com

★ 4.6 / 5.0

58 Verified Reviews

♥ 1 Customer Favorite



Vehicle serviced

Emissions inspection performed

07/24/2022 North Carolina
Motor Vehicle Dept.
Arden, NC
Title
#775995201620115

Registration issued or renewed

07/20/2023 131,708 T & J Auto Service
Arden, NC
828-687-8282
<https://tandjautoservice.net/arden-auto-repair-shop-location.html>

★ 4.9 / 5.0

38 Verified Reviews

♥ 27 Customer Favorites



Vehicle serviced

Oil and filter changed

07/20/2023 North Carolina
Motor Vehicle Dept.
Arden, NC
Title
#775995201620115

Registration issued or renewed



This vehicle uses an indicator light to alert users when it's time to change the oil. Oil changes have been reported to CARFAX at least every 15,000 miles, which is in line with manufacturer guidelines. Track your service history for free at [carfax.com/service](https://www.carfax.com/service).

Have Questions? Consumers, please visit our Help Center at www.carfax.com. Dealers or Subscribers, please visit our Help Center at www.carfaxonline.com.



Glossary

Accident Indicator

CARFAX receives information about accidents in all 50 states, the District of Columbia and Canada.

Not every accident is reported to CARFAX. As details about the accident become available, those additional details are added to the CARFAX Vehicle History Report. CARFAX recommends that you have this vehicle inspected by a qualified mechanic.

- According to the National Safety Council, Injury Facts, 2021 edition, 5% of the 276 million registered vehicles in the U.S. were involved in an accident in 2019. Over 77% of these were considered minor or moderate.
- This CARFAX Vehicle History Report is based only on information supplied to CARFAX and available as of 12/21/23 at 11:13:34 AM (CST). Other information about this vehicle, including problems, may not have been reported to CARFAX. Use this report as one important tool, along with a vehicle inspection and test drive, to make a better decision about your next used car.

CARFAX Well Maintained - Regular Oil Changes

CARFAX identifies a "Well Maintained - Regular Oil Change" vehicle as having a regular oil change history when all its recommended oil changes, based on the vehicle's maintenance schedule, have been reported to CARFAX. CARFAX uses the manufacturer's schedule and assumes normal driving conditions. When an oil change schedule is not available, CARFAX may analyze reported service events to determine what is typical for the same make and model vehicle. Dealers and service shops may publish different recommended service schedules.

Damage Severity

Damage events result in one of the following severity levels:

- Minor: Generally, minor damage is cosmetic (including dents or scratches), may only require reconditioning, and typically does not compromise a vehicle's operation and/or safety.
- Moderate: Moderate damage may affect multiple components of the vehicle and may impair the vehicle's operation and/or safety.
- Severe: Severe damage usually affects multiple components of the vehicle and is likely to compromise the vehicle's operation and/or safety.

CARFAX recommends getting a pre-purchase inspection at a certified collision repair facility.

First Owner

When the first owner(s) obtains a title from a Department of Motor Vehicles as proof of ownership.

Inspections

Many states or counties require annual or biennial emissions and/or safety inspections. Odometer readings are collected at the time of the inspection.

Manufacturer Recall

Automobile manufacturers issue recall notices to inform vehicle owners of a safety defect or failure to meet minimum federal safety or emissions standards. Manufacturer recalls are repaired at no cost to the customer.

New Owner Reported

When a vehicle is sold to a new owner, the Title must be transferred to the new owner(s) at a Department of

Motor Vehicles.

Ownership History

CARFAX defines an owner as an individual or business that possesses and uses a vehicle. Not all title transactions represent changes in ownership. To provide estimated number of owners, CARFAX proprietary technology analyzes all the events in a vehicle history. Estimated ownership is available for vehicles manufactured after 1991 and titled solely in the US including Puerto Rico. Dealers sometimes opt to take ownership of a vehicle and are required to in the following states: Maine, Massachusetts, New Jersey, Ohio, Oklahoma, Pennsylvania and South Dakota. Please consider this as you review a vehicle's estimated ownership history.

Title Issued

A state issues a title to provide a vehicle owner with proof of ownership. Each title has a unique number. Each title or registration record on a CARFAX report does not necessarily indicate a change in ownership. In Canada, a registration and bill of sale are used as proof of ownership.

Follow Us:



[facebook.com/CARFAX](https://www.facebook.com/CARFAX)



[@CARFAXinc](https://twitter.com/CARFAXinc)



About CARFAX

CARFAX DEPENDS ON ITS SOURCES FOR THE ACCURACY AND RELIABILITY OF ITS INFORMATION. THEREFORE, NO RESPONSIBILITY IS ASSUMED BY CARFAX OR ITS AGENTS FOR ERRORS OR OMISSIONS IN THIS REPORT. CARFAX FURTHER EXPRESSLY DISCLAIMS ALL WARRANTIES, EXPRESS OR IMPLIED, INCLUDING ANY IMPLIED WARRANTIES OF MERCHANTABILITY OR FITNESS FOR A PARTICULAR PURPOSE.

© 2023 CARFAX, Inc., part of S&P Global. All rights reserved.
12/21/23 11:13:34 AM (CST)

I have reviewed and received a copy of the CARFAX Vehicle History Report for this 2006 BMW 3 SERIES vehicle (VIN: WBAVD13596KV07528), which is based on information supplied to CARFAX and available as of 12/21/23 at 12:13 PM (EST).

Customer Signature

Date

Dealer Signature

Date