



### History-Based Value Report

**\$4,960**

CARFAX Retail Value

#### History events affecting this vehicle's value

- Service History
- Personal Vehicle
- Minor Damage



### Vehicle History Report™

US \$44.99

**2009 SUBARU  
FORESTER 2.5 X  
LIMITED**

VIN: JF2SH64699H700103  
4 DOOR WAGON/SPORT  
UTILITY  
2.5L H4 F SOHC 16V  
GASOLINE  
ALL WHEEL DRIVE



**35** Service history records

**4** Previous owners

Personal vehicle

**164,779** Last reported odometer reading



This CARFAX Vehicle History Report is based only on information supplied to CARFAX and available as of 12/14/24 at 7:55:48 AM (CST). Other information about this vehicle, including problems, may not have been reported to

CARFAX. Use this report as one important tool, along with a vehicle inspection and test drive, to make a better decision about your next used car.



### Accident / Damage History

Not all accidents / issues are reported to CARFAX

#### Event 1

01/20/2018

**Damage reported:**  
minor damage

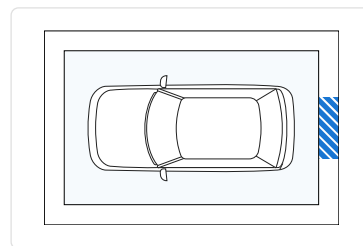
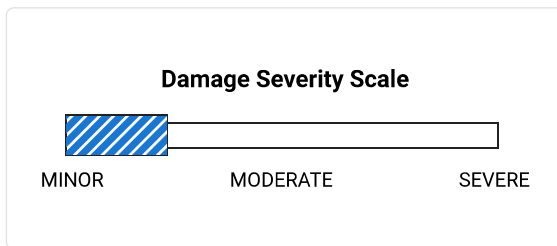

#### Event 2

05/30/2018

**Accident reported:**  
minor damage

Involving front or side impact  
Airbags did not deploy

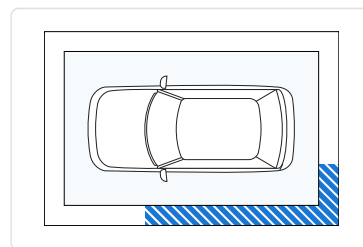
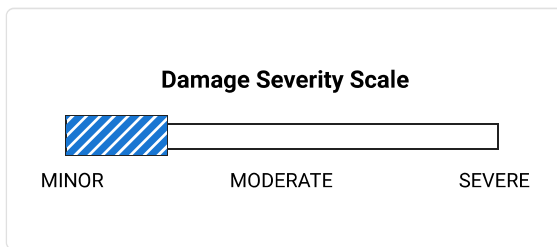

#### Event 3

09/18/2019

**Damage reported:**  
minor damage

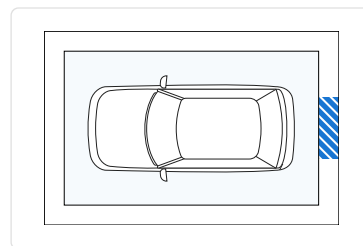
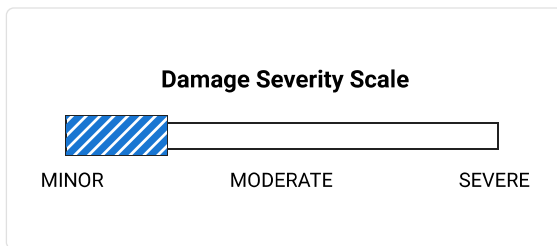



### Additional History

Not all accidents / issues are reported to CARFAX

	Owners 1-2	Owner 3	Owner 4
<b>Total Loss</b> No total loss reported to CARFAX.	<input checked="" type="checkbox"/> No Issues Reported	<input checked="" type="checkbox"/> No Issues Reported	<input checked="" type="checkbox"/> No Issues Reported
<b>Structural Damage</b> CARFAX recommends that you have this vehicle	<input checked="" type="checkbox"/> No Issues Reported	<input checked="" type="checkbox"/> No Issues Reported	<input checked="" type="checkbox"/> No Issues Reported

inspected by a collision repair specialist.			
<b>Airbag Deployment</b> No airbag deployment reported to CARFAX.	<input checked="" type="checkbox"/> No Issues Reported	<input checked="" type="checkbox"/> No Issues Reported	<input checked="" type="checkbox"/> No Issues Reported
<b>Odometer Check</b> No indication of an odometer rollback.	<input checked="" type="checkbox"/> No Issues Indicated	<input checked="" type="checkbox"/> No Issues Indicated	<input checked="" type="checkbox"/> No Issues Indicated
<b>Accident / Damage</b> Damage reported: 01/20/2018 and 09/18/2019. Accident reported: 05/30/2018.	Minor Damage	No New Issues Reported	No New Issues Reported
<b>Manufacturer Recall</b> No open recalls reported to CARFAX.	<input checked="" type="checkbox"/> No Recalls Reported	<input checked="" type="checkbox"/> No Recalls Reported	<input checked="" type="checkbox"/> No Recalls Reported
<b>Basic Warranty</b> Original warranty estimated to have expired.	<b>Warranty Expired</b>	<b>Warranty Expired</b>	<b>Warranty Expired</b>

 <b>Title History</b> CARFAX guarantees the information in this section	Owners 1-2	Owner 3	Owner 4
<b>Damage Brands</b> Salvage   Junk   Rebuilt   Fire   Flood   Hail   Lemon	<input checked="" type="checkbox"/> <b>Guaranteed</b> No Problem	<input checked="" type="checkbox"/> <b>Guaranteed</b> No Problem	<input checked="" type="checkbox"/> <b>Guaranteed</b> No Problem
<b>Odometer Brands</b> Not Actual Mileage   Exceeds Mechanical Limits	<input checked="" type="checkbox"/> <b>Guaranteed</b> No Problem	<input checked="" type="checkbox"/> <b>Guaranteed</b> No Problem	<input checked="" type="checkbox"/> <b>Guaranteed</b> No Problem



**GUARANTEED** - None of these title problems were reported by a U.S. state Department of Motor Vehicles (DMV). If you find that any of these title problems were reported by a DMV and not included in this report, you may qualify.  
[View Terms](#) | [View Certificate](#)

 <b>Ownership History</b> The number of owners is estimated	Owners 1-2	Owner 3	Owner 4
Year purchased	2009	2021	2024
Type of owner	Personal	Personal	Personal
Estimated length of ownership	11 yrs. 9 mo.	3 yrs. 7 mo.	2 months
Owned in the following states/provinces	See Details	New York	Michigan
Estimated miles driven per year	See Details	13,739/yr	---
Last reported odometer reading	120,673	164,779	---



## Detailed History







**Owner 1**  
Purchased: 2009











**Low mileage!** This owner drove less than the industry average of 15,000 miles per year.

Personal Vehicle  
10,344 mi/yr

Date	Mileage	Source	Comments
11/03/2008	6,256	Auto Auction	<b>Listed as a manufacturer vehicle</b> Vehicle sold
			Millions of used vehicles are bought and sold at auction every year.
01/22/2009	7,525	Massachusetts Motor Vehicle Dept.	<b>Vehicle purchase reported</b> Titled or registered as personal vehicle
01/31/2009	7,576	Massachusetts Inspection Station Hanover, MA	<b>Passed safety inspection</b>
02/13/2009		Massachusetts Motor Vehicle Dept. Carver, MA Title #BG529804	<b>Title issued or updated</b> First owner reported Vehicle color noted as Green
06/01/2009		Massachusetts Motor Vehicle Dept. Carver, MA Title #BG529804	<b>Registration issued or renewed</b> Loan or lien reported Vehicle color noted as Green
01/23/2010	16,405	Massachusetts Inspection Station North Carver, MA	<b>Passed safety inspection</b> Passed emissions inspection
01/22/2011	26,860	Massachusetts Inspection Station North Carver, MA	<b>Passed safety inspection</b> Passed emissions inspection
06/01/2011		Massachusetts Motor Vehicle Dept. Carver, MA Title #BG529804	<b>Registration issued or renewed</b> Loan or lien reported Vehicle color noted as Green
02/04/2012	38,270	Massachusetts Inspection Station North Carver, MA	<b>Passed safety inspection</b> Passed emissions inspection

04/01/2013		Valvoline Instant Oil Change Plymouth, MA 508-732-0022 vioc.com ★ <b>4.7 / 5.0</b> 384 Verified Reviews ♥ <b>318</b> Customer Favorites		<b>Vehicle serviced</b> Oil and filter changed
04/01/2013	50,250	Massachusetts Inspection Station Plymouth, MA		<b>Passed safety inspection</b> Passed emissions inspection
06/01/2013		Massachusetts Motor Vehicle Dept. Carver, MA Title #BG529804		<b>Registration issued or renewed</b> Loan or lien reported Vehicle color noted as Green
09/01/2013	54,905	Valvoline Instant Oil Change Plymouth, MA 508-732-0022 vioc.com ★ <b>4.7 / 5.0</b> 384 Verified Reviews ♥ <b>318</b> Customer Favorites		<b>Vehicle serviced</b> Oil and filter changed
12/02/2013	58,182	Valvoline Instant Oil Change Plymouth, MA 508-732-0022 vioc.com ★ <b>4.7 / 5.0</b> 384 Verified Reviews ♥ <b>318</b> Customer Favorites		<b>Vehicle serviced</b> Oil and filter changed Air filter replaced
05/17/2014	62,811	Massachusetts Inspection Station North Carver, MA		<b>Passed safety inspection</b> Passed emissions inspection
05/19/2014	62,855	Valvoline Instant Oil Change Plymouth, MA 508-732-0022 vioc.com ★ <b>4.7 / 5.0</b> 384 Verified Reviews ♥ <b>318</b> Customer Favorites		<b>Vehicle serviced</b> Oil and filter changed

11/13/2014	67,149	Valvoline Instant Oil Change Plymouth, MA 508-732-0022 vioc.com ★ <b>4.7 / 5.0</b> 384 Verified Reviews ♥ <b>318</b> Customer Favorites		<b>Vehicle serviced</b> Oil and filter changed
03/30/2015		National Tire & Battery Plymouth, MA 508-732-0057 ntb.com ★ <b>4.5 / 5.0</b> 19 Verified Reviews ♥ <b>24</b> Customer Favorites		<b>Vehicle serviced</b> Tire condition and pressure checked Oil and filter changed Tires rotated
06/01/2015		Massachusetts Motor Vehicle Dept. Carver, MA Title #BG529804		<b>Registration issued or renewed</b> Vehicle color noted as Green
07/16/2015	74,500	Massachusetts Inspection Station Plymouth, MA		<b>Passed safety inspection</b> Passed emissions inspection
07/17/2015		National Tire & Battery Plymouth, MA 508-732-0057 ntb.com ★ <b>4.5 / 5.0</b> 19 Verified Reviews ♥ <b>24</b> Customer Favorites		<b>Vehicle serviced</b> Oil and filter changed Tires rotated
12/30/2015	79,392	Valvoline Instant Oil Change Plymouth, MA 508-732-0022 vioc.com ★ <b>4.7 / 5.0</b> 384 Verified Reviews ♥ <b>318</b> Customer Favorites		<b>Vehicle serviced</b> Oil and filter changed Air filter replaced
08/06/2016	85,157	Massachusetts Inspection Station North Carver, MA		<b>Passed safety inspection</b> Passed emissions inspection

10/24/2016 88,153	Valvoline Instant Oil Change Plymouth, MA 508-732-0022 vioc.com		<b>Vehicle serviced</b> Oil and filter changed
	★ <b>4.7 / 5.0</b> 384 Verified Reviews ❤️ <b>318</b> Customer Favorites		
02/10/2017	National Tire & Battery Plymouth, MA 508-732-0057 ntb.com		<b>Vehicle serviced</b> Electrical system checked Tire condition and pressure checked Battery/charging system checked Oil and filter changed Tires rotated Battery replaced
	★ <b>4.5 / 5.0</b> 19 Verified Reviews ❤️ <b>24</b> Customer Favorites		
04/26/2017 93,003	Mastria Subaru of Raynham Raynham, MA 508-880-9799 mastriasubaru.com		<b>Vehicle offered for sale</b>
	★ <b>4.8 / 5.0</b> 206 Verified Reviews ❤️ <b>7</b> Customer Favorites		
04/27/2017 93,004	Mastria Subaru of Raynham Raynham, MA 508-880-9799 mastriasubaru.com		<b>Vehicle serviced</b> Recommended maintenance performed Maintenance inspection completed Brakes checked Oil and filter changed Exterior lights checked Tire condition and pressure checked Fluids checked Cooling system hoses checked Drive belts checked Body lubricated Battery/charging system checked
	★ <b>4.8 / 5.0</b> 206 Verified Reviews ❤️ <b>7</b> Customer Favorites		
		Looks like this dealer serviced the car in order to prepare it for sale. That's a good thing!	
05/10/2017 93,053	Auto Auction		<b>Vehicle sold</b>
05/13/2017	Dealer Inventory		<b>Vehicle offered for sale</b>
06/21/2017 93,062	Dealer Inventory		<b>Vehicle offered for sale</b>





**Owner 2**

Purchased: 2017



**Low mileage!** This owner drove less than the industry average of 15,000 miles per year.

Personal Vehicle  
7,866 mi/yr

Date	Mileage	Source	Comments
07/22/2017		Rhode Island Motor Vehicle Dept.	<b>Vehicle purchase reported</b>
07/28/2017	93,091	Rhode Island Motor Vehicle Dept. Providence, RI Title #99029075	<b>Title issued or updated</b> Registration issued or renewed New owner reported Loan or lien reported Vehicle color noted as Green
08/01/2017	97,252	Monro Auto Service & Tire Centers Providence, RI  ★ <b>5.0 / 5.0</b> 11 Verified Reviews ❤️ <b>2</b> Customer Favorites	 <b>Vehicle serviced</b>
12/15/2017	98,235	Valvoline Instant Oil Change Seekonk, MA 508-336-6336 vioc.com  ★ <b>4.4 / 5.0</b> 222 Verified Reviews ❤️ <b>285</b> Customer Favorites	 <b>Vehicle serviced</b> Oil and filter changed Air filter replaced Front wiper blades/refills replaced
01/20/2018		Damage Report	 <b>Damage reported: minor damage</b> Damage to rear





**CARFAX HAS THE MOST ACCIDENT & DAMAGE INFORMATION**

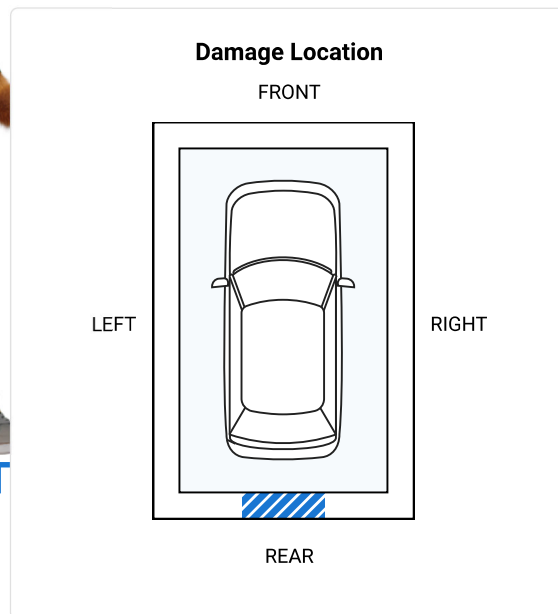
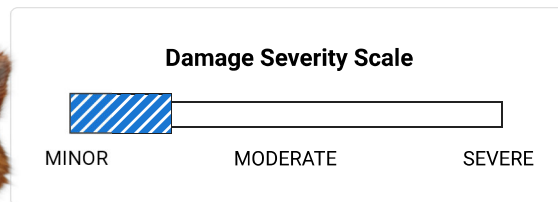

Minor damage is usually cosmetic, including dents or scratches to the vehicle body.

03/23/2018 100,571 Valvoline Instant Oil Change  
 Seekonk, MA  
 508-336-6336  
 vioc.com  
 ★ 4.4 / 5.0  
 222 Verified Reviews  
 ♥ 285 Customer Favorites



**Vehicle serviced**  
 Oil and filter changed  
 Cabin air filter replaced/cleaned

03/31/2018 101,529 Grand Prix Subaru  
 Hicksville, NY  
 844-366-6001  
 grandprixsubaru.net  
 ★ 4.6 / 5.0  
 485 Verified Reviews  
 ♥ 2,650 Customer Favorites



**Vehicle serviced**  
 Maintenance inspection completed  
 Right airbag assembly replaced

05/30/2018

Damage Report



**Accident reported: minor damage**

Involving front or side impact  
 Damage to left side  
 Damage to left rear  
 Airbags did not deploy



**CARFAX HAS THE MOST ACCIDENT & DAMAGE INFORMATION**

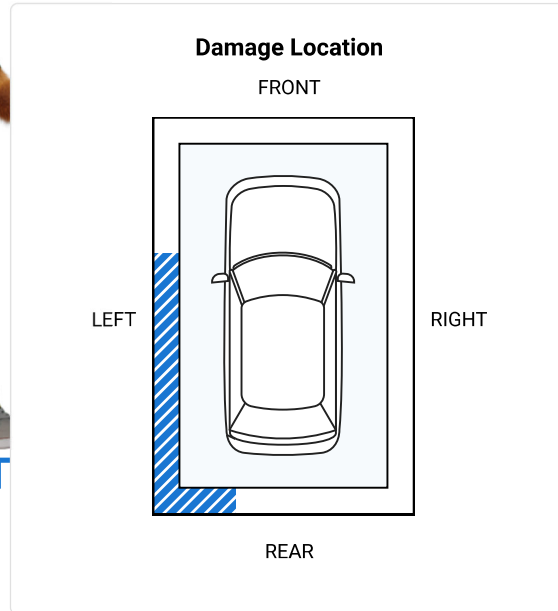
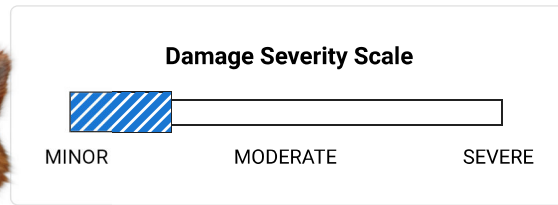

07/20/2018 103,404

Valvoline Instant Oil Change  
 Seekonk, MA  
 508-336-6336  
 vioc.com



**Vehicle serviced**

Oil and filter changed

★ **4.4 / 5.0**  
 222 Verified Reviews  
 ❤️ **285** Customer Favorites

08/06/2018

Rhode Island Motor Vehicle Dept.  
 Providence, RI

**Registration issued or renewed**

Vehicle color noted as Green

08/24/2018 105,016







Monro Auto Service & Tire Centers  
 Providence, RI



**Vehicle serviced**

Tires rotated

★ **5.0 / 5.0**  
 11 Verified Reviews  
 ❤️ **2** Customer Favorites



09/21/2018	106,474	Valvoline Instant Oil Change Seekonk, MA 508-336-6336 vioc.com ★ 4.4 / 5.0 222 Verified Reviews ❤️ 285 Customer Favorites		<b>Vehicle serviced</b> Oil and filter changed
12/14/2018	108,436	Valvoline Instant Oil Change Seekonk, MA 508-336-6336 vioc.com ★ 4.4 / 5.0 222 Verified Reviews ❤️ 285 Customer Favorites		<b>Vehicle serviced</b> Power steering fluid flushed/changed Oil and filter changed
04/18/2019	110,345	Valvoline Instant Oil Change Seekonk, MA 508-336-6336 vioc.com ★ 4.4 / 5.0 222 Verified Reviews ❤️ 285 Customer Favorites		<b>Vehicle serviced</b> Air filter replaced Fuel injection system checked Oil and filter changed
07/19/2019	112,961	Valvoline Instant Oil Change Seekonk, MA 508-336-6336 vioc.com ★ 4.4 / 5.0 222 Verified Reviews ❤️ 285 Customer Favorites		<b>Vehicle serviced</b> Tires rotated Oil and filter changed
08/31/2019	113,938	Monro Auto Service & Tire Centers Providence, RI 401-751-6612 monro.com ★ 5.0 / 5.0 11 Verified Reviews ❤️ 2 Customer Favorites		<b>Vehicle serviced</b> Maintenance inspection completed Emissions or safety inspection performed
09/18/2019		Damage Report		<b>Damage reported: minor damage</b> Damage to rear

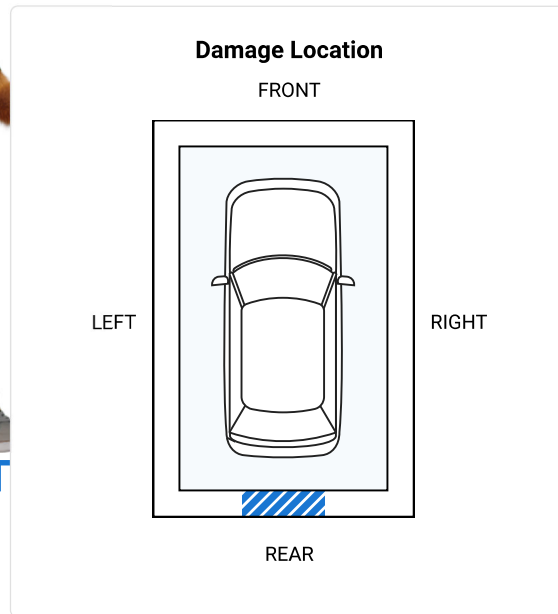
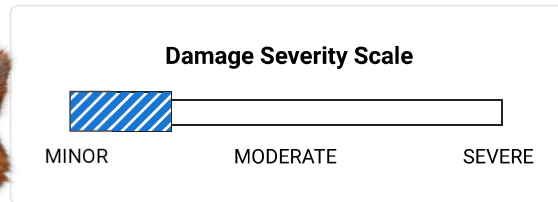

**CARFAX HAS THE MOST ACCIDENT & DAMAGE INFORMATION**



10/18/2019	114,553	Monro Auto Service & Tire Centers Providence, RI		<b>Vehicle serviced</b>
		★ <b>5.0 / 5.0</b> 11 Verified Reviews ♥ <b>2</b> Customer Favorites		
11/29/2019	115,047	Valvoline Instant Oil Change Cicero, NY 315-699-6281 vioc.com		<b>Vehicle serviced</b> Oil and filter changed
		★ <b>4.6 / 5.0</b> 184 Verified Reviews ♥ <b>254</b> Customer Favorites		
01/10/2020	116,572	Monro Auto Service & Tire Centers Providence, RI		<b>Vehicle serviced</b>
		★ <b>5.0 / 5.0</b> 11 Verified Reviews ♥ <b>2</b> Customer Favorites		
07/26/2020		Rhode Island Motor Vehicle Dept. Providence, RI		<b>Registration issued or renewed</b> Vehicle color noted as Green

08/14/2020	117,427	Mike'S Auto Repair Hicksville, NY 516-942-1913 ★ <b>5.0 / 5.0</b> 80 Verified Reviews ❤️ <b>32</b> Customer Favorites		<b>Vehicle serviced</b> Oil and filter changed Transmission cooler line(s) repaired/ replaced Transmission fluid changed Wiper(s) replaced
11/11/2020	119,114	Whittaker's Trophy Auto Sales Central Square, NY 315-668-7021 trophyauto.com ★ <b>5.0 / 5.0</b> 10 Verified Reviews ❤️ <b>1</b> Customer Favorite		<b>Vehicle serviced</b> Catalytic converter replaced Cylinder head gasket(s) replaced Engine oil/fluid leak checked
11/19/2020	119,170	Bill Rapp Superstore Syracuse, NY 315-437-2501 ★ <b>4.8 / 5.0</b> 421 Verified Reviews ❤️ <b>5,708</b> Customer Favorites		<b>Vehicle offered for sale</b>
12/10/2020	119,210	Online Listing		<b>Vehicle offered for sale</b>
12/10/2020		Auto Auction		<b>Vehicle sold</b>
12/14/2020		Bill Rapp Superstore Syracuse, NY 315-437-2501 billrapp.com ★ <b>4.5 / 5.0</b> 75 Verified Reviews		<b>Vehicle sold</b>
12/31/2020	119,240	New York Inspection Station		<b>Passed safety inspection</b> Passed emissions inspection
12/31/2020		New York Motor Vehicle Dept. Stamford, NY		<b>Registration issued or renewed</b> Titled or registered as personal vehicle Passed safety inspection
01/29/2021	120,201	Five Star Subaru Oneonta, NY 607-432-0201 fivestarcars.com ★ <b>4.9 / 5.0</b> 119 Verified Reviews ❤️ <b>50</b> Customer Favorites		<b>Vehicle serviced</b> Front wiper blades/refills replaced Fluids checked

02/10/2021 120,673 Five Star Subaru  
 Oneonta, NY  
 607-432-0201  
 fivestarcars.com

 **Vehicle serviced**  
 Front brake rotor(s) replaced  
 Front brake pads replaced



★ **4.9 / 5.0**  
 119 Verified Reviews  
 ❤️ **50** Customer Favorites





 **Owner 3**  
 Purchased: 2021



**Low mileage!** This owner drove less than the industry average of 15,000 miles per year.

Personal Vehicle  
 13,739 mi/yr

Date	Mileage	Source	Comments
02/16/2021		New York Motor Vehicle Dept. Stamford, NY	<b>Title issued or updated</b> New owner reported
09/09/2021	129,168	New Millennium Motors Inc Brooklyn, NY 718-831-6151 brooklyn-autorepairshop.com/ ★ <b>4.8 / 5.0</b> 32 Verified Reviews	 <b>Vehicle serviced</b> Battery/charging system checked
03/25/2022	132,966	New York Inspection Station	<b>Passed safety inspection</b> Failed emissions inspection
04/11/2022	133,646	New Millennium Motors Inc Brooklyn, NY 718-831-6151 brooklyn-autorepairshop.com/ ★ <b>4.8 / 5.0</b> 32 Verified Reviews	 <b>Vehicle serviced</b> Oil and filter changed Safety inspection performed Emissions inspection performed
04/11/2022		New York Inspection Station	<b>Passed safety inspection</b> Passed emissions inspection

04/14/2022	134,018	Subaru of Englewood Englewood, NJ 201-568-5200 subaruofenglewood.com/  ★ <b>4.5 / 5.0</b> 225 Verified Reviews ♥ <b>2,297</b> Customer Favorites		<b>Vehicle serviced</b> Maintenance inspection completed
04/30/2022	134,048	Bay Ridge Subaru Brooklyn, NY 718-234-7960 bayridgeautos.com  ★ <b>4.7 / 5.0</b> 356 Verified Reviews ♥ <b>152</b> Customer Favorites		<b>Vehicle serviced</b>
11/22/2022		New York Motor Vehicle Dept. Brooklyn, NY		<b>Registration issued or renewed</b> Titled or registered as personal vehicle Passed safety inspection Registration updated when owner moved the vehicle to a new location
04/21/2023	150,233	New York Inspection Station		<b>Passed safety inspection</b> Passed emissions inspection
10/04/2023	156,476	New Millennium Motors Inc Brooklyn, NY 718-831-6151 brooklyn-autorepairshop.com/  ★ <b>4.8 / 5.0</b> 32 Verified Reviews		<b>Vehicle serviced</b> Cabin air filter replaced/cleaned
01/31/2024	161,670	Bay Ridge Subaru Brooklyn, NY 718-234-7960 bayridgeautos.com  ★ <b>4.7 / 5.0</b> 356 Verified Reviews ♥ <b>152</b> Customer Favorites		<b>Vehicle serviced</b> Maintenance inspection completed Ignition coil(s) replaced Tire condition and pressure checked Lock cylinder(s) recoded Brake fluid flushed/changed Fuel injection system flushed/serviced
04/12/2024	164,779	New York Inspection Station		<b>Passed safety inspection</b> Passed emissions inspection



**Owner 4**  
Purchased: 2024

Personal Vehicle

Date	Mileage	Source	Comments
09/20/2024		Michigan Motor Vehicle Dept.	<b>Vehicle purchase reported</b>
09/23/2024		Michigan Motor Vehicle Dept. Kalamazoo, MI Title #MI0023056715	<b>Title issued or updated</b> New owner reported Exempt from odometer reporting

Have Questions? Consumers, please visit our Help Center at [www.carfax.com](http://www.carfax.com). Dealers or Subscribers, please visit our Help Center at [www.carfaxonline.com](http://www.carfaxonline.com).



## Glossary

### Accident Indicator

CARFAX receives information about accidents in all 50 states, the District of Columbia and Canada.

Not every accident is reported to CARFAX. As details about the accident become available, those additional details are added to the CARFAX Vehicle History Report. CARFAX recommends that you have this vehicle inspected by a qualified mechanic.

- According to the National Safety Council, Injury Facts, 2021 edition, 5% of the 276 million registered vehicles in the U.S. were involved in an accident in 2019. Over 77% of these were considered minor or moderate.
- This CARFAX Vehicle History Report is based only on information supplied to CARFAX and available as of 12/14/24 at 7:55:48 AM (CST). Other information about this vehicle, including problems, may not have been reported to CARFAX. Use this report as one important tool, along with a vehicle inspection and test drive, to make a better decision about your next used car.

### Damage Indicator

Damage can be a result of many different types of events. Examples include contact with objects (other cars, trees, traffic signs, road debris, etc), vandalism, or weather-related events. Not every damage event is reported to CARFAX. As details about the damage event become available, those additional details are added to the CARFAX Vehicle History Report. CARFAX recommends that you have this vehicle inspected by a qualified mechanic.

- This CARFAX Vehicle History Report is based only on information supplied to CARFAX and available as of 12/14/24 at 7:55:48 AM (CST). Other information about this vehicle, including problems, may not have been reported to CARFAX. Use this report as one important tool, along with a vehicle inspection and test drive, to make a better decision about your next used car.

### Damage Severity

Damage events result in one of the following severity levels:

- Minor: Generally, minor damage is cosmetic (including dents or scratches), may only require reconditioning, and typically does not compromise a vehicle's operation and/or safety.
- Moderate: Moderate damage may affect multiple components of the vehicle and may impair the vehicle's operation and/or safety.
- Severe: Severe damage usually affects multiple components of the vehicle and is likely to compromise the vehicle's operation and/or safety.

CARFAX recommends getting a pre-purchase inspection at a certified collision repair facility.

### Failed Emissions Inspection

The emissions check performed during a vehicle inspection indicated the vehicle was emitting more than allowable emissions standards and/or had missing or modified parts. Repeated failed emissions records can



indicate engine problems and CARFAX recommends you have the vehicle inspected.

**First Owner**

When the first owner(s) obtains a title from a Department of Motor Vehicles as proof of ownership.

**New Owner Reported**



When a vehicle is sold to a new owner, the Title must be transferred to the new owner(s) at a Department of Motor Vehicles.

**Ownership History**

CARFAX defines an owner as an individual or business that possesses and uses a vehicle. Not all title transactions represent changes in ownership. To provide estimated number of owners, CARFAX proprietary technology analyzes all the events in a vehicle history. Estimated ownership is available for vehicles manufactured after 1991 and titled solely in the US including Puerto Rico. Dealers sometimes opt to take ownership of a vehicle and are required to in the following states: Maine, Massachusetts, New Jersey, Ohio, Oklahoma, Pennsylvania and South Dakota. Please consider this as you review a vehicle's estimated ownership history.

**Title Issued**

A state issues a title to provide a vehicle owner with proof of ownership. Each title has a unique number. Each title or registration record on a CARFAX report does not necessarily indicate a change in ownership. In Canada, a registration and bill of sale are used as proof of ownership.

Follow Us:  [facebook.com/CARFAX](https://facebook.com/CARFAX)  [@CARFAXinc](https://twitter.com/CARFAXinc)  [About CARFAX](#)

CARFAX DEPENDS ON ITS SOURCES FOR THE ACCURACY AND RELIABILITY OF ITS INFORMATION. THEREFORE, NO RESPONSIBILITY IS ASSUMED BY CARFAX OR ITS AGENTS FOR ERRORS OR OMISSIONS IN THIS REPORT. CARFAX FURTHER EXPRESSLY DISCLAIMS ALL WARRANTIES, EXPRESS OR IMPLIED, INCLUDING ANY IMPLIED WARRANTIES OF MERCHANTABILITY OR FITNESS FOR A PARTICULAR PURPOSE.

© 2024 CARFAX, Inc., part of S&P Global. All rights reserved.  
12/14/24 7:55:48 AM (CST)

**I have reviewed and received a copy of the CARFAX Vehicle History Report for this 2009 SUBARU FORESTER vehicle (VIN: JF2SH64699H700103), which is based on information supplied to CARFAX and available as of 12/14/24 at 8:55 AM (EST).**

\_\_\_\_\_

<b>Customer Signature</b>	<b>Date</b>	<b>Dealer Signature</b>	<b>Date</b>
---------------------------	-------------	-------------------------	-------------