



History-Based Value Report

History events affecting this vehicle's value



Service History



Personal Vehicle



Multiple Owners



Minor Damage

\$6,800 Retail Value



Vehicle History Report™

US \$44.99

2009 DODGE JOURNEY SXT

VIN: 3D4GH57V39T154128
 4 DOOR WAGON/SPORT UTILITY
 3.5L V6 F SOHC 24V GASOLINE
 ALL WHEEL DRIVE

Accident reported: minor damage

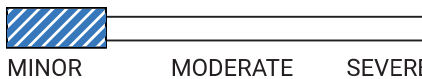

50 Service history records



5 Previous owners



Personal vehicle





99,375 Last reported odometer reading

This CARFAX Vehicle History Report is based only on information supplied to CARFAX and available as of 12/2/23 at 7:25:51 AM (CST). Other information about this vehicle, including problems, may not have been reported to CARFAX. Use this report as one important tool, along with a vehicle inspection and test drive, to make a better decision about your next used car.

 Ownership History The number of owners is estimated	Owners 1-3	Owner 4	Owner 5
Year purchased	2008	2018	2018
Type of owner	Personal	Personal	Personal
Estimated length of ownership	10 yrs. 5 mo.	1 month	4 yrs. 10 mo.
Owned in the following states/provinces	See Details	Idaho	Idaho
Estimated miles driven per year	See Details	---	5,385/yr
Last reported odometer reading	72,502	74,572	99,375

 Title History CARFAX guarantees the information in this section	Owners 1-3	Owner 4	Owner 5
Damage Brands Salvage Junk Rebuilt Fire Flood Hail Lemon	<input checked="" type="checkbox"/> Guaranteed No Problem	<input checked="" type="checkbox"/> Guaranteed No Problem	<input checked="" type="checkbox"/> Guaranteed No Problem
Odometer Brands Not Actual Mileage Exceeds Mechanical Limits	<input checked="" type="checkbox"/> Guaranteed No Problem	<input checked="" type="checkbox"/> Guaranteed No Problem	<input checked="" type="checkbox"/> Guaranteed No Problem

 **GUARANTEED** - None of these title problems were reported by a U.S. state Department of Motor Vehicles (DMV). If you find that any of these title problems were reported by a DMV and not included in this report, you may qualify.
[View Terms](#) | [View Certificate](#)

 Additional History Not all accidents / issues are reported to CARFAX	Owners 1-3	Owner 4	Owner 5
Total Loss No total loss reported to CARFAX.	<input checked="" type="checkbox"/> No Issues Reported	<input checked="" type="checkbox"/> No Issues Reported	<input checked="" type="checkbox"/> No Issues Reported
Structural Damage CARFAX recommends that you have this vehicle inspected by a collision repair specialist.	<input checked="" type="checkbox"/> No Issues Reported	<input checked="" type="checkbox"/> No Issues Reported	<input checked="" type="checkbox"/> No Issues Reported
Airbag Deployment No airbag deployment reported to CARFAX.	<input checked="" type="checkbox"/> No Issues Reported	<input checked="" type="checkbox"/> No Issues Reported	<input checked="" type="checkbox"/> No Issues Reported

Odometer Check No indication of an odometer rollback.	<input checked="" type="checkbox"/> No Issues Indicated	<input checked="" type="checkbox"/> No Issues Indicated	<input checked="" type="checkbox"/> No Issues Indicated
Accident / Damage Accident reported: 01/26/2017. Damage reported: 09/27/2018.	Minor Damage	No New Issues Reported	No New Issues Reported
Manufacturer Recall No open recalls reported to CARFAX.	<input checked="" type="checkbox"/> No Recalls Reported	<input checked="" type="checkbox"/> No Recalls Reported	<input checked="" type="checkbox"/> No Recalls Reported
Basic Warranty Original warranty estimated to have expired.	Warranty Expired	Warranty Expired	Warranty Expired

CARFAX Detailed History



Owner 1
Purchased: 2008

Personal Vehicle

Date	Mileage	Source	Comments
04/26/2008	19	Idaho Motor Vehicle Dept. Coeur d Alene, ID	Odometer reading reported
05/14/2008		Idaho Motor Vehicle Dept. Coeur d Alene, ID	Title issued or updated First owner reported Titled or registered as personal vehicle Loan or lien reported
06/23/2008		Idaho Motor Vehicle Dept. Coeur d Alene, ID	Title issued or updated







Owner 2
Purchased: 2008





Low mileage! This owner drove less than the industry average of 15,000 miles per year.







Personal Vehicle
11,043 mi/yr







Date	Mileage	Source	Comments
06/30/2008	619	Idaho Motor Vehicle Dept. Post Falls, ID	Odometer reading reported
08/14/2008		Idaho Motor Vehicle Dept. Post Falls, ID	Title issued or updated New owner reported







01/26/2009		Idaho Motor Vehicle Dept. Post Falls, ID		Registration issued or renewed Vehicle color noted as White
12/15/2009	16,745	Tom Addis Dodge Coeur D Alene, ID 208-664-4000 tomaddisdodge.com		Vehicle serviced Oil and filter changed Tire condition and pressure checked Air filter replaced
12/16/2009		Lake City Ford Coeur D Alene, ID 208-664-9211 lakecityford.com ★ 4.5 / 5.0 13 Verified Reviews		Vehicle offered for sale
12/18/2009		Lake City Ford Coeur D Alene, ID 208-664-9211 lakecityford.com ★ 4.5 / 5.0 13 Verified Reviews		Vehicle serviced Maintenance inspection completed Oil and filter changed
			Looks like this dealer serviced the car in order to prepare it for sale. That's a good thing!	
01/29/2010		Lake City Ford Coeur D Alene, ID 208-664-9211 lakecityford.com ★ 4.5 / 5.0 13 Verified Reviews		Vehicle sold
01/29/2010	16,806	Tom Addis Dodge Coeur D Alene, ID 208-664-4000 tomaddisdodge.com		Vehicle offered for sale
01/29/2010		Idaho Motor Vehicle Dept. Hayden, ID		Registration issued or renewed Vehicle color noted as White
02/11/2010	17,150	Lake City Ford Coeur D Alene, ID 208-664-9211 lakecityford.com ★ 4.5 / 5.0 13 Verified Reviews		Vehicle serviced













02/12/2010	Tom Addis Dodge Coeur D Alene, ID 208-664-4000 tomaddisdodge.com		Vehicle serviced Trailer hitch installed
------------	---	---	--





 Owner 3 Purchased: 2010		Low mileage! This owner drove less than the industry average of 15,000 miles per year.	Personal Vehicle 6,649 mi/yr
---	---	---	---------------------------------

Date	Mileage	Source		Comments
03/04/2010		Idaho Motor Vehicle Dept. Hayden, ID		Title issued or updated New owner reported
03/09/2010	18,539	Tom Addis Dodge Coeur D Alene, ID 208-664-4000 tomaddisdodge.com		Vehicle serviced Oil and filter changed Tire condition and pressure checked
07/14/2010	21,066	Tom Addis Dodge Coeur D Alene, ID 208-664-4000 tomaddisdodge.com		Vehicle serviced Maintenance inspection completed Oil and filter changed Tire condition and pressure checked
10/09/2010	24,053	Tom Addis Dodge Coeur D Alene, ID 208-664-4000 tomaddisdodge.com		Vehicle serviced Maintenance inspection completed Oil and filter changed Tire condition and pressure checked
01/26/2011	25,637	Tom Addis Dodge Coeur D Alene, ID 208-664-4000 tomaddisdodge.com		Vehicle serviced Maintenance inspection completed Oil and filter changed Fluids checked Tire condition and pressure checked
03/07/2011	26,246	Tom Addis Dodge Coeur D Alene, ID 208-664-4000 tomaddisdodge.com		Vehicle serviced Maintenance inspection completed
05/25/2011		Idaho Motor Vehicle Dept. Hayden, ID		Registration issued or renewed Vehicle color noted as White
06/30/2011	28,872	Tom Addis Dodge Coeur D Alene, ID 208-664-4000 tomaddisdodge.com		Vehicle serviced Maintenance inspection completed Oil and filter changed Fluids checked Tire condition and pressure checked Safety inspection performed

10/13/2011	31,077	Tom Addis Dodge Coeur D Alene, ID 208-664-4000 tomaddisdodge.com		Vehicle serviced Maintenance inspection completed Fluids checked Oil and filter changed Tire condition and pressure checked Battery/charging system checked
01/17/2012	32,945	Findlay Chrysler Jeep Dodge Ram Post Falls, ID 208-457-1900 postfallschryslerjeepdodgeram.com ★ 4.6 / 5.0 476 Verified Reviews ❤️ 5,348 Customer Favorites		Vehicle serviced Maintenance inspection completed Oil and filter changed Maintenance reminder reset
04/17/2012	34,876	Tom Addis Dodge Coeur D Alene, ID 208-664-4000 tomaddisdodge.com		Vehicle serviced Maintenance inspection completed Brakes checked Oil and filter changed Fluids checked Tire condition and pressure checked Maintenance reminder reset Tires rotated
12/19/2012	39,427	Midway Hyundai Post Falls, ID 888-739-1747 gotomidwayhyundai.com/		Vehicle serviced Maintenance inspection completed Oil and filter changed Maintenance reminder reset Air filter replaced Tires rotated
01/31/2013	40,011	Midway Hyundai Post Falls, ID 888-739-1747 gotomidwayhyundai.com/		Vehicle serviced Maintenance inspection completed Rear brake pads replaced Brake rotor(s) resurfaced
05/08/2013	41,563	Midway Hyundai Post Falls, ID 888-739-1747 gotomidwayhyundai.com/		Vehicle serviced Maintenance inspection completed Oil and filter changed Maintenance reminder reset
05/20/2013		Idaho Motor Vehicle Dept. Hayden, ID		Registration issued or renewed Vehicle color noted as White

10/10/2013	44,019	Midway Hyundai Post Falls, ID 888-739-1747 gotomidwayhyundai.co m/		Vehicle serviced Maintenance inspection completed Oil and filter changed Wheel lug nuts torqued
03/04/2014	46,450	Midway Hyundai Post Falls, ID 888-739-1747 gotomidwayhyundai.co m/		Vehicle serviced Oil and filter changed
05/29/2014	48,436	Midway Hyundai Post Falls, ID 888-739-1747 gotomidwayhyundai.co m/		Vehicle serviced Maintenance inspection completed Oil and filter changed
07/09/2014	52,544	Midway Hyundai Post Falls, ID 888-739-1747 gotomidwayhyundai.co m/		Vehicle serviced Maintenance inspection completed Oil and filter changed
09/09/2014	54,136	Findlay Chrysler Jeep Dodge Ram Post Falls, ID 208-457-1900 postfallschryslerjeepdod geram.com ★ 4.6 / 5.0 476 Verified Reviews ❤️ 5,348 Customer Favorites		Vehicle serviced Maintenance inspection completed Oil and filter changed
01/08/2015	56,906	Findlay Chrysler Jeep Dodge Ram Post Falls, ID 208-457-1900 postfallschryslerjeepdod geram.com ★ 4.6 / 5.0 476 Verified Reviews ❤️ 5,348 Customer Favorites		Vehicle serviced Maintenance inspection completed Oil and filter changed Wiper(s) replaced

03/23/2015 58,892	Findlay Chrysler Jeep Dodge Ram Post Falls, ID 208-457-1900 postfallschryslerjeepdodgeram.com		Vehicle serviced Maintenance inspection completed Oil and filter changed Maintenance reminder reset
 4.6 / 5.0 476 Verified Reviews  5,348 Customer Favorites			
05/20/2015	Idaho Motor Vehicle Dept. Hayden, ID	Registration issued or renewed Vehicle color noted as White	
06/29/2015 61,935	Findlay Chrysler Jeep Dodge Ram Post Falls, ID 208-457-1900 postfallschryslerjeepdodgeram.com		Vehicle serviced Maintenance inspection completed Oil and filter changed
 4.6 / 5.0 476 Verified Reviews  5,348 Customer Favorites			
10/13/2015 63,811	Findlay Chrysler Jeep Dodge Ram Post Falls, ID 208-457-1900 postfallschryslerjeepdodgeram.com		Vehicle serviced Maintenance inspection completed Oil and filter changed
 4.6 / 5.0 476 Verified Reviews  5,348 Customer Favorites			
01/13/2016 65,395	Findlay Chrysler Jeep Dodge Ram Post Falls, ID 208-457-1900 postfallschryslerjeepdodgeram.com		Vehicle serviced Maintenance inspection completed Oil and filter changed Transmission serviced
 4.6 / 5.0 476 Verified Reviews  5,348 Customer Favorites			

08/03/2016	67,530	Findlay Chrysler Jeep Dodge Ram Post Falls, ID 208-457-1900 postfallschryslerjeepdod geram.com ★ 4.6 / 5.0 476 Verified Reviews ♥ 5,348 Customer Favorites		Vehicle serviced Maintenance inspection completed Oil and filter changed
08/12/2016	67,608	Findlay Chrysler Jeep Dodge Ram Post Falls, ID 208-457-1900 postfallschryslerjeepdod geram.com ★ 4.6 / 5.0 476 Verified Reviews ♥ 5,348 Customer Favorites		Vehicle serviced
08/29/2016		Idaho Motor Vehicle Dept. Post Falls, ID		Registration issued or renewed Correction to record Registration updated when owner moved the vehicle to a new location Vehicle color noted as White
11/23/2016	69,528	Findlay Chrysler Jeep Dodge Ram Post Falls, ID 208-457-1900 postfallschryslerjeepdod geram.com ★ 4.6 / 5.0 476 Verified Reviews ♥ 5,348 Customer Favorites		Vehicle serviced Maintenance inspection completed Oil and filter changed Wiper(s) replaced
01/26/2017		Damage Report		Accident reported: minor damage Involving front or side impact Damage to right front Airbags did not deploy



CARFAX HAS THE MOST ACCIDENT & DAMAGE INFORMATION

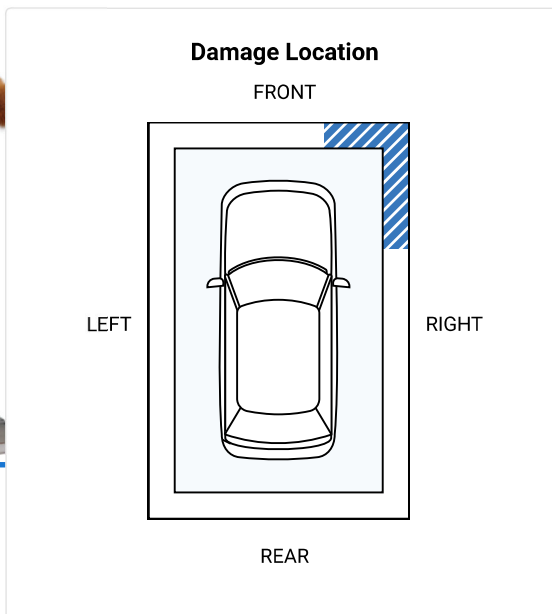
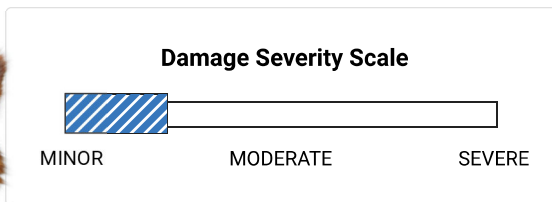

Minor damage is usually cosmetic, including dents or scratches to the vehicle body.

04/12/2017 70,391

Findlay Chrysler Jeep
Dodge Ram
Post Falls, ID
208-457-1900
postfallschryslerjeepdodgeram.com

★ 4.6 / 5.0
476 Verified Reviews
♥ 5,348 Customer Favorites



Vehicle serviced

Maintenance inspection completed
Oil and filter changed
Airbag computer/module reprogrammed

05/15/2017

Idaho
Motor Vehicle Dept.
Post Falls, ID

Registration issued or renewed

Vehicle color noted as White

11/20/2017 71,854

Findlay Chrysler Jeep
Dodge Ram
Post Falls, ID
208-457-1900
postfallschryslerjeepdod
geram.com



Vehicle serviced
Oil and filter changed

★ 4.6 / 5.0
476 Verified Reviews
♥ 5,348 Customer Favorites

04/18/2018 72,502

Findlay Chrysler Jeep
Dodge Ram
Post Falls, ID
208-457-1900
postfallschryslerjeepdod
geram.com



Vehicle serviced
Maintenance inspection completed
Oil and filter changed

★ 4.6 / 5.0
476 Verified Reviews
♥ 5,348 Customer Favorites

09/27/2018

Damage Report



Damage reported: minor damage
Damage to rear



**CARFAX HAS THE MOST
ACCIDENT & DAMAGE
INFORMATION**

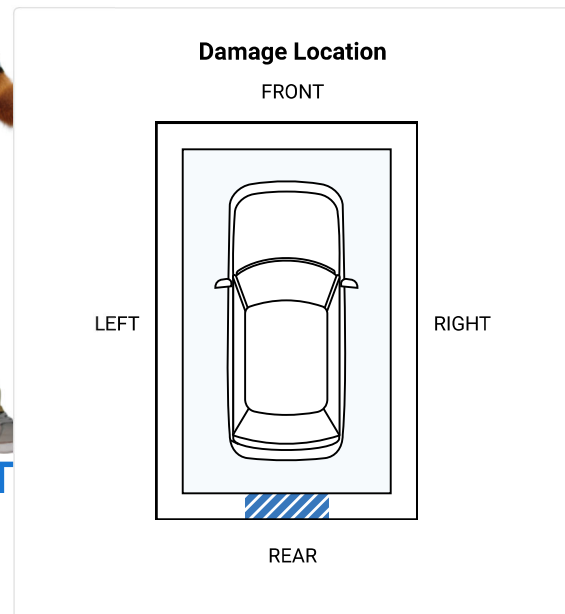
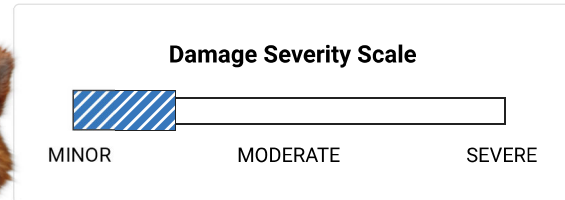



Minor damage is usually cosmetic, including dents or scratches to the vehicle body.

10/22/2018	Idaho Motor Vehicle Dept.	Vehicle purchase reported
10/26/2018	Idaho Motor Vehicle Dept. Athol, ID	Registration issued or renewed Vehicle color noted as White



















Owner 4 Personal Vehicle
Purchased: 2018





Date	Mileage	Source	Comments
10/31/2018	74,572	Idaho Motor Vehicle Dept. Athol, ID	Vehicle purchase reported Title issued or updated New owner reported Vehicle color noted as White
11/09/2018		Idaho Motor Vehicle Dept. Coeur d Alene, ID	Registration issued or renewed Vehicle color noted as White
12/06/2018		Idaho Motor Vehicle Dept. Coeur d Alene, ID	Vehicle purchase reported Registration issued or renewed Vehicle color noted as White

Owner 5 Personal Vehicle
5,385 mi/yr
Purchased: 2018

Low mileage! This owner drove less than the industry average of 15,000 miles per year.

Date	Mileage	Source	Comments
12/14/2018		Idaho Motor Vehicle Dept. Coeur d Alene, ID	Title issued or updated New owner reported Vehicle color noted as White
12/15/2018	75,473	Walmart Auto Care Center Post Falls, ID 208-773-7993 https://www.walmart.com 4.4 / 5.0 44 Verified Reviews 2 Customer Favorites	Vehicle serviced Oil and filter changed

03/13/2019	77,862	Lloyd's Automotive Spokane, WA 509-443-2200  4.9 / 5.0 10 Verified Reviews  20 Customer Favorites		Vehicle serviced Fluids checked
04/08/2019	78,689	Valvoline Instant Oil Change Coeur D Alene, ID 208-772-6722 vioc.com  4.7 / 5.0 182 Verified Reviews  282 Customer Favorites		Vehicle serviced Air filter replaced Oil and filter changed
05/09/2019	79,705	Lloyd's Automotive Coeur D'Ale, ID 208-667-9757  4.7 / 5.0 99 Verified Reviews  257 Customer Favorites		Vehicle serviced
09/07/2019	82,406	Valvoline Instant Oil Change Coeur D Alene, ID 208-772-6722 vioc.com  4.7 / 5.0 182 Verified Reviews  282 Customer Favorites		Vehicle serviced Fluids checked Oil and filter changed
12/24/2019	84,523	Valvoline Instant Oil Change Coeur D Alene, ID 208-772-6722 vioc.com  4.7 / 5.0 182 Verified Reviews  282 Customer Favorites		Vehicle serviced Brake light bulb(s) replaced Oil and filter changed
04/28/2020	85,291	Valvoline Instant Oil Change Coeur D Alene, ID 208-772-6722 vioc.com  4.7 / 5.0 182 Verified Reviews  282 Customer Favorites		Vehicle serviced Tire condition and pressure checked

08/22/2020	87,424	Valvoline Instant Oil Change Coeur D Alene, ID 208-772-6722 vioc.com ★ 4.7 / 5.0 182 Verified Reviews ♥ 282 Customer Favorites		Vehicle serviced Oil and filter changed Air filter replaced
12/07/2020	88,454	Valvoline Instant Oil Change Coeur D Alene, ID 208-772-6722 vioc.com ★ 4.7 / 5.0 182 Verified Reviews ♥ 282 Customer Favorites		Vehicle serviced Oil and filter changed Tire condition and pressure checked
01/15/2021		Idaho Motor Vehicle Dept. Coeur d Alene, ID		Registration issued or renewed Vehicle color noted as White
04/24/2021		Service Facility		Inspection performed
06/30/2021	90,156	Valvoline Instant Oil Change Coeur D Alene, ID 208-772-6722 vioc.com ★ 4.7 / 5.0 182 Verified Reviews ♥ 282 Customer Favorites		Vehicle serviced Oil and filter changed
07/23/2021	90,435	Findlay Chrysler Jeep Dodge Ram Post Falls, ID 208-457-1900 postfallschryslerjeepdodgeram.com ★ 4.6 / 5.0 476 Verified Reviews ♥ 5,348 Customer Favorites		Vehicle serviced Maintenance inspection completed

11/16/2021	92,842	Valvoline Instant Oil Change Coeur D Alene, ID 208-772-6722 vioc.com		Vehicle serviced Oil and filter changed
		★ 4.7 / 5.0 182 Verified Reviews ♥ 282 Customer Favorites		
05/04/2022	95,362	Valvoline Instant Oil Change Coeur D Alene, ID 208-772-6722 vioc.com		Vehicle serviced Oil and filter changed
		★ 4.7 / 5.0 182 Verified Reviews ♥ 282 Customer Favorites		
07/25/2022	96,733	Lake City Auto Care Hayden, ID 208-772-1450 https://lakecityautocare.com/		Vehicle serviced Maintenance inspection completed
		★ 4.2 / 5.0 38 Verified Reviews ♥ 276 Customer Favorites		
10/13/2022	96,738	Findlay Chrysler Jeep Dodge Ram Post Falls, ID 208-457-1900 postfallschryslerjeepdodgeram.com		Vehicle serviced Maintenance inspection completed Oil and filter changed
		★ 4.6 / 5.0 476 Verified Reviews ♥ 5,348 Customer Favorites		
12/13/2022		Idaho Motor Vehicle Dept. Coeur d Alene, ID		Registration issued or renewed Vehicle color noted as White
01/26/2023	97,797	Valvoline Instant Oil Change Coeur D Alene, ID 208-772-6722 vioc.com		Vehicle serviced Tire condition and pressure checked
		★ 4.7 / 5.0 182 Verified Reviews ♥ 282 Customer Favorites		

05/23/2023 99,375

Valvoline Instant Oil
Change
Coeur D Alene, ID
208-772-6722
vioc.com

**Vehicle serviced**

Front wiper blades/refills replaced
Oil and filter changed
Air filter replaced

★ 4.7 / 5.0

182 Verified Reviews

♥ 282 Customer Favorites

10/18/2023

Auto Auction

Vehicle offered for sale

Have Questions? Consumers, please visit our Help Center at www.carfax.com. Dealers or Subscribers, please visit our Help Center at www.carfaxonline.com.

**Glossary****Accident Indicator**

CARFAX receives information about accidents in all 50 states, the District of Columbia and Canada.

Not every accident is reported to CARFAX. As details about the accident become available, those additional details are added to the CARFAX Vehicle History Report. CARFAX recommends that you have this vehicle inspected by a qualified mechanic.

- According to the National Safety Council, Injury Facts, 2021 edition, 5% of the 276 million registered vehicles in the U.S. were involved in an accident in 2019. Over 77% of these were considered minor or moderate.
- This CARFAX Vehicle History Report is based only on information supplied to CARFAX and available as of 12/2/23 at 7:25:51 AM (CST). Other information about this vehicle, including problems, may not have been reported to CARFAX. Use this report as one important tool, along with a vehicle inspection and test drive, to make a better decision about your next used car.

Damage Indicator

Damage can be a result of many different types of events. Examples include contact with objects (other cars, trees, traffic signs, road debris, etc), vandalism, or weather-related events. Not every damage event is reported to CARFAX. As details about the damage event become available, those additional details are added to the CARFAX Vehicle History Report. CARFAX recommends that you have this vehicle inspected by a qualified mechanic.

- This CARFAX Vehicle History Report is based only on information supplied to CARFAX and available as of 12/2/23 at 7:25:51 AM (CST). Other information about this vehicle, including problems, may not have been reported to CARFAX. Use this report as one important tool, along with a vehicle inspection and test drive, to make a better decision about your next used car.

Damage Severity

Damage events result in one of the following severity levels:

- Minor: Generally, minor damage is cosmetic (including dents or scratches), may only require reconditioning, and typically does not compromise a vehicle's operation and/or safety.
- Moderate: Moderate damage may affect multiple components of the vehicle and may impair the vehicle's operation and/or safety.
- Severe: Severe damage usually affects multiple components of the vehicle and is likely to compromise the vehicle's operation and/or safety.

CARFAX recommends getting a pre-purchase inspection at a certified collision repair facility.

First Owner

When the first owner(s) obtains a title from a Department of Motor Vehicles as proof of ownership.

New Owner Reported

When a vehicle is sold to a new owner, the Title must be transferred to the new owner(s) at a Department of Motor Vehicles.

Ownership History

CARFAX defines an owner as an individual or business that possesses and uses a vehicle. Not all title transactions represent changes in ownership. To provide estimated number of owners, CARFAX proprietary technology analyzes all the events in a vehicle history. Estimated ownership is available for vehicles manufactured after 1991 and titled solely in the US including Puerto Rico. Dealers sometimes opt to take ownership of a vehicle and are required to in the following states: Maine, Massachusetts, New Jersey, Ohio, Oklahoma, Pennsylvania and South Dakota. Please consider this as you review a vehicle's estimated ownership history.

Title Issued

A state issues a title to provide a vehicle owner with proof of ownership. Each title has a unique number. Each title or registration record on a CARFAX report does not necessarily indicate a change in ownership. In Canada, a registration and bill of sale are used as proof of ownership.

Follow Us:



facebook.com/CARFAX



[@CARFAXinc](https://twitter.com/CARFAXinc)



About CARFAX

CARFAX DEPENDS ON ITS SOURCES FOR THE ACCURACY AND RELIABILITY OF ITS INFORMATION. THEREFORE, NO RESPONSIBILITY IS ASSUMED BY CARFAX OR ITS AGENTS FOR ERRORS OR OMISSIONS IN THIS REPORT. CARFAX FURTHER EXPRESSLY DISCLAIMS ALL WARRANTIES, EXPRESS OR IMPLIED, INCLUDING ANY IMPLIED WARRANTIES OF MERCHANTABILITY OR FITNESS FOR A PARTICULAR PURPOSE.

© 2023 CARFAX, Inc., part of S&P Global. All rights reserved.
12/2/23 7:25:51 AM (CST)

I have reviewed and received a copy of the CARFAX Vehicle History Report for this 2009 DODGE JOURNEY vehicle (VIN: 3D4GH57V39T154128), which is based on information supplied to CARFAX and available as of 12/2/23 at 8:25 AM (EST).

Customer Signature

Date

Dealer Signature

Date