



Report

US \$44.99

2002 Toyota 4Runner SR5

257,027 mi | VIN: JT3GN86R520255187 |

4 Door Wagon/Sport Utility | 3.4L V6 F DOHC 24V | Gasoline | Rear wheel drive

CARFAX HAS THE MOST ACCIDENT & DAMAGE INFORMATION



ACCIDENT

Airbag Deployed

CARFAX VALUE \$6,070

34 Service History Records

5 Previous Owners

Personal Vehicle

Last Owned in Tennessee

86 Detailed Records Available

This CARFAX Vehicle History Report is based only on information supplied to CARFAX and available as of 5/28/26 at 11:10:35 AM (CDT). Other information about this vehicle, including problems, may not have been reported to CARFAX. Use this report as one important tool, along with a vehicle inspection and test drive, to make a better decision about your next used car.



Accident / Damage History

Not all accidents / issues are reported to CARFAX

Event 1

09/24/2009

Accident reported

- Vehicle towed
- Airbag deployed

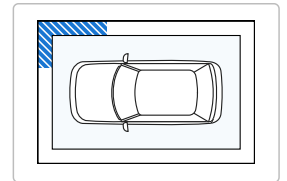

Event 2

07/27/2010

Accident reported: moderate damage with another motor vehicle

- Airbags did not deploy

Damage Severity Scale

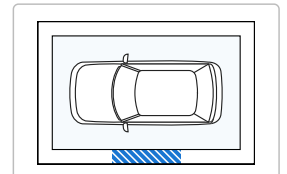

Event 3

05/20/2019

Accident reported

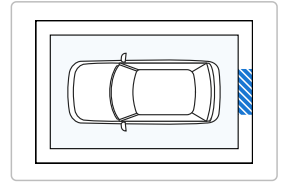

Event 4

01/12/2020

Accident reported: minor damage

- Involving front or side impact with another motor vehicle

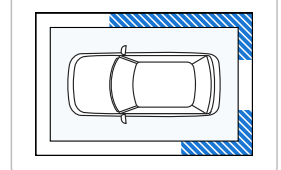
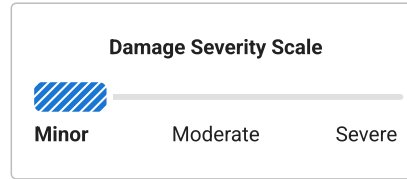

Event 5

02/04/2023

Accident reported: minor damage

- Involving front or side impact
- Airbags did not deploy

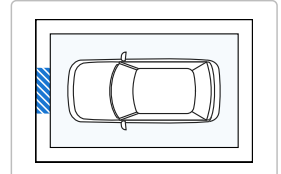
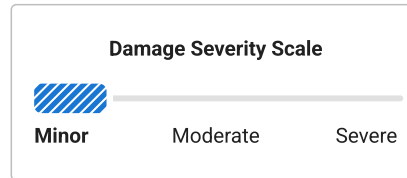

History-Based Value Report

\$6,070

CARFAX Retail Value

History events affecting this vehicle's value

- Service History
- Personal Vehicle
- Airbag Deployed
- Accident Reported



Additional History

Not all accidents / issues are reported to CARFAX

	Owners 1-3	Owner 4	Owner 5
Total Loss No total loss reported to CARFAX.	No Issues Reported	No Issues Reported	No Issues Reported
Structural Damage CARFAX recommends that you have this vehicle inspected by a collision repair specialist.	No Issues Reported	No Issues Reported	No Issues Reported
Airbag Deployment Airbag deployment reported: 09/24/2009.	Airbag Deployment	No New Issues Reported	No New Issues Reported
Odometer Check No indication of an odometer rollback.	No Issues Indicated	No Issues Indicated	No Issues Indicated
Accident / Damage Accidents reported: 09/24/2009, 07/27/2010, 05/20/2019, 01/12/2020, and 02/04/2023.	Accident Reported	No New Issues Reported	Accident Reported

Manufacturer Recall No open recalls reported to CARFAX. View Toyota disclosure	No Recalls Reported	No Recalls Reported	No Recalls Reported
Basic Warranty Original warranty estimated to have expired.	Warranty Expired	Warranty Expired	Warranty Expired

Title History	Owners 1-3	Owner 4	Owner 5
Damage Brands Salvage Junk Rebuilt Fire Flood Hail Lemon	No Problem	No Problem	No Problem
Odometer Brands Not Actual Mileage Exceeds Mechanical Limits	No Problem	No Problem	No Problem

Ownership History The number of owners is estimated	Owners 1-3	Owner 4	Owner 5
Year purchased	2002	2011	2013
Type of owner	Personal	Personal	Personal
Estimated length of ownership	8 yrs. 2 mo.	1 yr. 7 mo.	13 yrs. 3 mo.
Owned in the following states/provinces	See Details	Tennessee	Tennessee
Estimated miles driven per year	See Details	19,559/yr	8,967/yr
Last reported odometer reading	120,473	146,000	257,027

Detailed History			
Owner 1 Purchased: 2002			Personal Vehicle 15,609 mi/yr
Date	Mileage	Source	Comments
07/18/2002		NICB	Vehicle manufactured and shipped to original dealer
11/08/2002	86	Texas Motor Vehicle Dept. Houston, TX Title #10130837557151401	Title issued or updated - First owner reported - Titled or registered as personal vehicle - Loan or lien reported
10/09/2003	15,176	Texas Motor Vehicle Dept. Houston, TX Title #10140537891144322	Title issued or updated - Correction to record - Loan or lien reported - Passed safety inspection
08/12/2004	30,000	Texas Inspection Station Houston, TX	Passed emissions or safety inspection
10/25/2004		Texas Motor Vehicle Dept. Houston, TX Title #10140537891144322	Title issued or updated - Loan or lien reported - Passed safety inspection
01/07/2005	34,896	Dealer Inventory Houston, TX	Vehicle offered for sale
02/10/2005	34,905	Auto Auction	Listed as a dealer vehicle - Vehicle sold
02/22/2005	35,005	Don McGill Toyota Of Katy Katy, TX 832-772-1000 donmcgilltoyotakaty.com ★ 4.3 / 5.0 1,141 Verified Reviews	Vehicle serviced - Maintenance inspection completed - Antifreeze/coolant flushed/changed - Cooling system serviced - Transmission fluid changed

♥ 29,455 Customer Favorites

- Two wheel alignment performed

02/25/2005



35,251

Dealer Inventory

Vehicle offered for sale

 **Owner 2**
Purchased: 2005

Personal Vehicle
9,170 mi/yr

Date	Mileage	Source	Comments
06/08/2005		Texas Motor Vehicle Dept. Santa Fe, TX Title #10131438495080728	Title issued or updated - New owner reported - Loan or lien reported
08/24/2005		Kwik Kar Oil & Lube Santa Fe, TX 409-927-1558 ★ 5.0 / 5.0 33 Verified Reviews	 Vehicle serviced - Oil and filter changed
08/24/2005	40,378	Texas Inspection Station La Marque, TX	Passed emissions or safety inspection
09/26/2005		CARFAX	This vehicle was registered in a county declared a flood disaster area by the Federal Emergency Management Agency (FEMA). <div style="border: 1px solid #ccc; padding: 5px; margin-top: 5px;">Of course not every car in this area was affected by the flood, but I'd still get it inspected before buying. Can't be too careful.</div>
10/01/2005		Texas Motor Vehicle Dept. Santa Fe, TX Title #10131438495080728	Title issued or updated - Registration issued or renewed - Loan or lien reported - Passed safety inspection - Registration updated when owner moved the vehicle to a new location
09/05/2006	48,240	Texas Inspection Station Hitchcock, TX	Passed safety inspection - Passed emissions inspection
10/11/2007	59,924	Auto Auction	Listed as a dealer vehicle - Vehicle sold
10/13/2007		Toyota of Gallatin Gallatin, TN 629-276-7245 toyotagallatin.com/ ★ 4.4 / 5.0 62 Verified Reviews ♥ 11,683 Customer Favorites	 Vehicle serviced - Pre-delivery inspection completed - Alignment checked - Alignment performed - Battery replaced - Four tires balanced - Four tires mounted - Four tires replaced - Four wheel alignment performed - Throttle body cleaned/serviced - Tune-up performed - Vehicle washed/detailed
10/18/2007		Tennessee Inspection Station Sumner County	Passed emissions inspection
10/26/2007	59,931	Dealer Inventory Gallatin, TN	Vehicle offered for sale
10/31/2007		Tennessee Motor Vehicle Dept. Gallatin, TN Title #77150666	Dealer took title of this vehicle while it was in inventory - Title or registration issued - Loan or lien reported
11/02/2007		Toyota Certified Dealer Gallatin, TN	Offered for sale as a Toyota Certified Used Vehicle - Gray interior - Thunder exterior



12/13/2007	61,542	Toyota of Gallatin Gallatin, TN 629-276-7245 toyotagallatin.com/ ★ 4.4 / 5.0 62 Verified Reviews ♥ 11,683 Customer Favorites		Vehicle serviced
01/23/2008	63,379	Toyota of Gallatin Gallatin, TN 629-276-7245 toyotagallatin.com/ ★ 4.4 / 5.0 62 Verified Reviews ♥ 11,683 Customer Favorites		Vehicle serviced
10/01/2008	76,000	Tennessee Inspection Station Sumner County		Passed emissions inspection
05/18/2009	89,753	Toyota of Gallatin Gallatin, TN 629-276-7245 toyotagallatin.com/ ★ 4.4 / 5.0 62 Verified Reviews ♥ 11,683 Customer Favorites		Vehicle serviced - Recommended maintenance performed - Oil and filter changed - Tire(s) balanced - Tires rotated - Vehicle washed/detailed
09/18/2009	97,000	Tennessee Inspection Station Sumner County		Passed emissions inspection
09/21/2009		Tennessee Motor Vehicle Dept. Gallatin, TN Title #77150666		Registration issued or renewed - Loan or lien reported
09/24/2009		Damage Report		Accident reported - Damage to right front - Vehicle towed - Airbag deployed CARFAX Airbag Tips

CARFAX HAS THE MOST ACCIDENT & DAMAGE INFORMATION

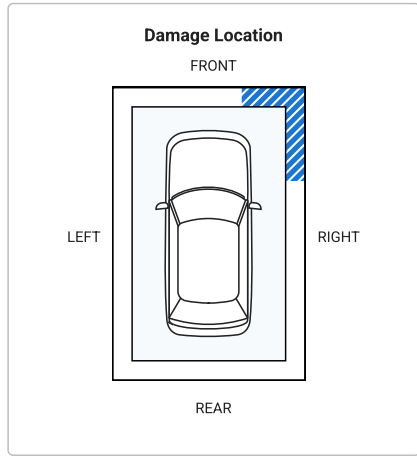

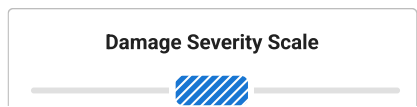

07/27/2010		Damage Report		Accident reported: moderate damage with another motor vehicle - Damage to left side - Airbags did not deploy
------------	--	---------------	--	---

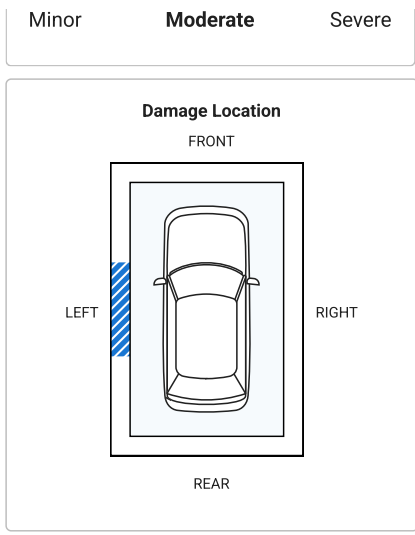

CARFAX HAS THE MOST ACCIDENT & DAMAGE INFORMATION



10/04/2010	115,000	Tennessee Inspection Station Sumner County	Failed emissions inspection
10/11/2010	116,000	Tennessee Inspection Station Sumner County	Passed emissions inspection
12/30/2010		Toyota of Gallatin Gallatin, TN 629-276-7245 toyotagallatin.com/ ★ 4.4 / 5.0 62 Verified Reviews ♥ 11,683 Customer Favorites	 Vehicle serviced - Maintenance inspection completed - Front brake rotor(s) resurfaced - Safety inspection performed - Tire(s) balanced - Tires rotated - Vehicle washed/detailed
12/30/2010	120,000	Tennessee Inspection Station Sumner County	Passed emissions inspection









 Owner 3 Purchased: 2011	Personal Vehicle		
Date	Mileage	Source	Comments
01/25/2011		Tennessee Motor Vehicle Dept. Gallatin, TN Title #77150666	Title issued or updated - New owner reported - Loan or lien reported
01/27/2011	120,473	Dealer Inventory Gallatin, TN	Vehicle offered for sale
02/05/2011		Toyota of Gallatin Gallatin, TN 629-276-7245 toyotagallatin.com/ ★ 4.4 / 5.0 62 Verified Reviews ♥ 11,683 Customer Favorites	 Vehicle serviced
06/21/2011		Online Listing	Vehicle offered for sale
06/30/2011		Toyota of Gallatin Gallatin, TN 629-276-7245 toyotagallatin.com/ ★ 4.4 / 5.0 62 Verified Reviews ♥ 11,683 Customer Favorites	Vehicle sold











 Owner 4 Purchased: 2011	Personal Vehicle 19,559 mi/yr
---	----------------------------------







Date	Mileage	Source	Comments
07/09/2011	120,600	Tennessee Motor Vehicle Dept.	Vehicle purchase reported
08/31/2011	122,000	Tennessee Inspection Station Williamson County	Passed emissions inspection
09/08/2011		Tennessee Motor Vehicle Dept. Brentwood, TN Title #84013805	Title or registration issued - New owner reported - Vehicle color noted as Silver
09/28/2011		Tennessee Motor Vehicle Dept. Brentwood, TN Title #87594495	Title issued or updated - Loan or lien reported - Vehicle color noted as Silver
09/27/2012		Tennessee Inspection Station Williamson County	Failed emissions inspection
10/16/2012	145,000	Tennessee Inspection Station Williamson County	Emissions inspection performed
10/25/2012	146,000	Tennessee Inspection Station Williamson County	Passed emissions inspection

 **Owner 5**
Purchased: 2013

Personal Vehicle
8,967 mi/yr

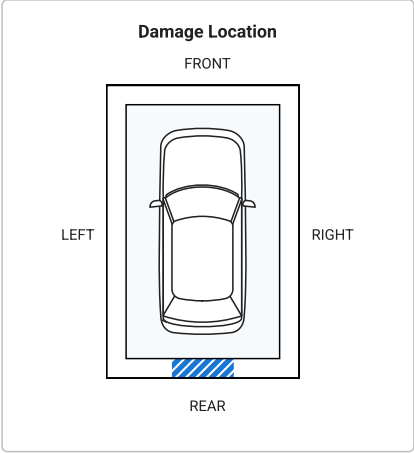



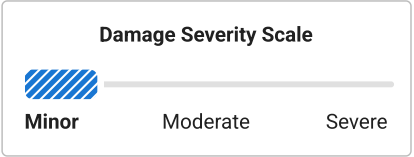

Date	Mileage	Source	Comments
02/22/2013	150,058	Tennessee Motor Vehicle Dept.	Vehicle purchase reported
03/08/2013		Tennessee Motor Vehicle Dept. Antioch, TN Title #91344613	Title or registration issued - New owner reported - Vehicle color noted as Silver
06/19/2013	153,688	Bass Tire, Inc. Nashville, TN 615-333-9673  5.0 / 5.0 510 Verified Reviews  59 Customer Favorites	 Vehicle serviced - Oil and filter changed - Tires rotated
11/27/2013	159,906	Bass Tire, Inc. Nashville, TN 615-333-9673  5.0 / 5.0 510 Verified Reviews  59 Customer Favorites	 Vehicle serviced - Oil and filter changed - Tires rotated
04/05/2014		Tennessee Motor Vehicle Dept. Antioch, TN Title #91344613	Registration issued or renewed - Vehicle color noted as Silver
06/19/2014	166,377	Bass Tire, Inc. Nashville, TN 615-333-9673  5.0 / 5.0 510 Verified Reviews  59 Customer Favorites	 Vehicle serviced - Oil and filter changed - Tires rotated
04/06/2015		Tennessee Motor Vehicle Dept. Antioch, TN Title #91344613	Registration issued or renewed - Vehicle color noted as Silver

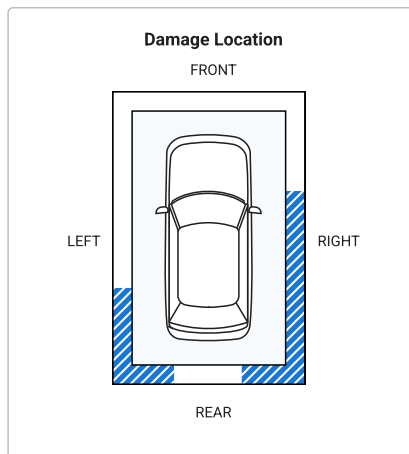
04/23/2015	176,577	Bass Tire, Inc. Nashville, TN 615-333-9673 ★ 5.0 / 5.0 510 Verified Reviews ♥ 59 Customer Favorites		Vehicle serviced - Brakes checked - Brakes serviced - Front brake pads replaced - Front brake rotor(s) replaced - Oil and filter changed - Tires rotated
06/15/2015	178,876	Bass Tire, Inc. Nashville, TN 615-333-9673 ★ 5.0 / 5.0 510 Verified Reviews ♥ 59 Customer Favorites		Vehicle serviced - Oil and filter changed - Tire(s) balanced
06/25/2015	180,089	Bass Tire, Inc. Nashville, TN 615-333-9673 ★ 5.0 / 5.0 510 Verified Reviews ♥ 59 Customer Favorites		Vehicle serviced - Brake drum(s) resurfaced - Brakes serviced - Front brake rotor(s) resurfaced
08/12/2015	181,433	Bass Tire, Inc. Nashville, TN 615-333-9673 ★ 5.0 / 5.0 510 Verified Reviews ♥ 59 Customer Favorites		Vehicle serviced - Oil and filter changed - Tires rotated
11/24/2015	183,927	Meineke Car Care Center Knoxville, TN 865-690-8801 ★ 4.3 / 5.0 32 Verified Reviews		Vehicle serviced - Maintenance inspection completed
01/06/2016	185,023	Bass Tire, Inc. Nashville, TN 615-333-9673 ★ 5.0 / 5.0 510 Verified Reviews ♥ 59 Customer Favorites		Vehicle serviced - Battery/charging system checked - Drive belt(s) replaced - Oil and filter changed - Tires rotated
08/08/2016	190,329	Bass Tire, Inc. Nashville, TN 615-333-9673 ★ 5.0 / 5.0 510 Verified Reviews ♥ 59 Customer Favorites		Vehicle serviced - Brakes checked - Oil and filter changed - Tires rotated
02/24/2017	194,981	Bass Tire, Inc. Nashville, TN 615-333-9673 ★ 5.0 / 5.0 510 Verified Reviews ♥ 59 Customer Favorites		Vehicle serviced - Oil and filter changed - Tires rotated
10/06/2017	199,633	Bass Tire, Inc. Nashville, TN 615-333-9673 ★ 5.0 / 5.0 510 Verified Reviews ♥ 59 Customer Favorites		Vehicle serviced - Tires rotated
01/18/2018		Tennessee Motor Vehicle Dept. Antioch, TN Title #91344613		Registration issued or renewed - Correction to record - Vehicle color noted as Silver
06/13/2018	205,795	Jim Phibbs Auto Service Knoxville, TN 865-588-3678 jimphibbsautoservice.napaautootoo ls.com/ ★ 5.0 / 5.0 122 Verified Reviews ♥ 20 Customer Favorites		Vehicle serviced - Fuel filter replaced - Mass air flow sensor replaced - Oil and filter changed - Radiator cap replaced - Wiper(s) replaced

08/11/2018	206,559	Service Facility ★ 4.5 / 5.0 260 Verified Reviews	 Vehicle serviced - Maintenance inspection completed
11/23/2018	208,059	Bass Tire, Inc. Nashville, TN 615-333-9673 ★ 5.0 / 5.0 510 Verified Reviews ♥ 59 Customer Favorites	 Vehicle serviced - Maintenance inspection completed - Oil and filter changed - Tires rotated
03/21/2019		Tennessee Motor Vehicle Dept. Antioch, TN Title #91344613	Title or registration issued - Vehicle color noted as Silver
05/20/2019		Damage Report	 Accident reported - Damage to rear <div style="display: flex; align-items: center; margin-top: 10px;"> <div style="flex: 1;"> <p>CARFAX HAS THE MOST ACCIDENT & DAMAGE INFORMATION</p> </div> <div style="flex: 2; border: 1px solid black; padding: 10px; text-align: center;"> <p>Damage Location</p>  </div> </div>
05/22/2019	211,403	Bass Tire, Inc. Nashville, TN 615-333-9673 ★ 5.0 / 5.0 510 Verified Reviews ♥ 59 Customer Favorites	 Vehicle serviced - Maintenance inspection completed - Oil and filter changed - Tires rotated
10/01/2019	215,828	Bass Tire, Inc. Nashville, TN 615-333-9673 ★ 5.0 / 5.0 510 Verified Reviews ♥ 59 Customer Favorites	 Vehicle serviced - Maintenance inspection completed - Brakes checked - Oil and filter changed - Tires rotated
11/11/2019	217,123	Bass Tire, Inc. Nashville, TN 615-333-9673 ★ 5.0 / 5.0 510 Verified Reviews ♥ 59 Customer Favorites	 Vehicle serviced - Maintenance inspection completed - Tire repaired
01/12/2020		Damage Report	Accident reported: minor damage - Involving front or side impact with another motor vehicle - Damage to right side - Damage to right rear - Damage to left rear <div style="display: flex; align-items: center; margin-top: 10px;"> <div style="flex: 1;"> <p>Damage Severity Scale</p>  </div> </div>

CARFAX HAS THE MOST ACCIDENT & DAMAGE INFORMATION



02/15/2020	219,695	<p>Bass Tire, Inc. Nashville, TN 615-333-9673</p> <p>★ 5.0 / 5.0 510 Verified Reviews</p> <p>♥ 59 Customer Favorites</p>	 <p>Vehicle serviced</p> <ul style="list-style-type: none"> - Maintenance inspection completed - Oil and filter changed - Tires rotated
03/05/2020		<p>Tennessee Motor Vehicle Dept. Antioch, TN Title #91344613</p>	<p>Registration issued or renewed</p> <ul style="list-style-type: none"> - Vehicle color noted as Silver
01/15/2021	221,647	<p>Bass Tire, Inc. Nashville, TN 615-333-9673</p> <p>★ 5.0 / 5.0 510 Verified Reviews</p> <p>♥ 59 Customer Favorites</p>	 <p>Vehicle serviced</p> <ul style="list-style-type: none"> - Maintenance inspection completed - Air filter replaced - Brakes checked - Oil and filter changed - Tire repaired - Tires rotated
03/29/2021		<p>Tennessee Motor Vehicle Dept. Antioch, TN Title #91344613</p>	<p>Registration issued or renewed</p> <ul style="list-style-type: none"> - Vehicle color noted as Silver
04/02/2021	226,228	<p>Bass Tire, Inc. Nashville, TN 615-333-9673</p> <p>★ 5.0 / 5.0 510 Verified Reviews</p> <p>♥ 59 Customer Favorites</p>	 <p>Vehicle serviced</p> <ul style="list-style-type: none"> - Maintenance inspection completed - Oil and filter changed - Tire condition and pressure checked - Tire(s) balanced - Tire(s) replaced
06/22/2021	229,650	<p>Bass Tire, Inc. Nashville, TN 615-333-9673</p> <p>★ 5.0 / 5.0 510 Verified Reviews</p> <p>♥ 59 Customer Favorites</p>	 <p>Vehicle serviced</p> <ul style="list-style-type: none"> - Maintenance inspection completed - Brakes checked - Brakes serviced - Front brake pads replaced - Front brake rotor(s) replaced - Wiper(s) replaced
08/06/2021	231,489	<p>Bass Tire, Inc. Nashville, TN 615-333-9673</p> <p>★ 5.0 / 5.0 510 Verified Reviews</p> <p>♥ 59 Customer Favorites</p>	 <p>Vehicle serviced</p> <ul style="list-style-type: none"> - Maintenance inspection completed - Oil and filter changed - Tires rotated
08/06/2021		<p>Bass Tire Company Nashville, TN 352-286-6441 basstire.com/</p> <p>★ 4.8 / 5.0 22 Verified Reviews</p> <p>♥ 6 Customer Favorites</p>	 <p>Vehicle serviced</p> <ul style="list-style-type: none"> - Oil and filter changed
01/20/2022	237,080	<p>Valvoline Instant Oil Change West Hartford, CT</p>	 <p>Vehicle serviced</p> <ul style="list-style-type: none"> - Battery replaced

860-232-5601
 vioc.com
 ★ 4.6 / 5.0 416 Verified Reviews
 ❤️ 379 Customer Favorites

- Drain plug gasket replaced
- Oil and filter changed
- Vehicle washed/detailed

07/05/2022

Tennessee
 Motor Vehicle Dept.
 Antioch, TN
 Title #91344613

Registration issued or renewed
 - Correction to record
 - Vehicle color noted as Silver

02/04/2023

Damage Report

Accident reported: minor damage
 - Involving front or side impact
 - Damage to front
 - Airbags did not deploy

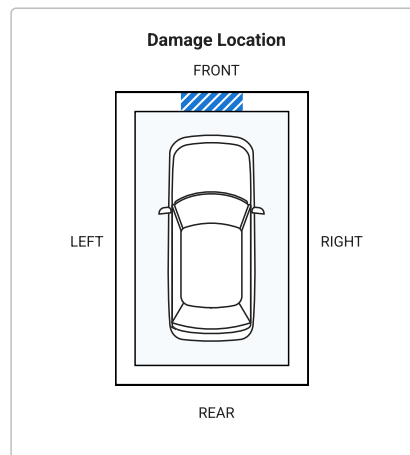
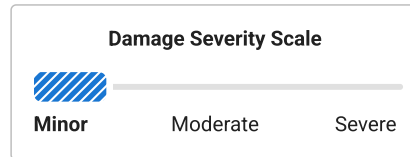

**CARFAX HAS THE MOST
 ACCIDENT & DAMAGE
 INFORMATION**

06/20/2023

Tennessee
 Motor Vehicle Dept.
 Antioch, TN
 Title #91344613

Registration issued or renewed
 - Vehicle color noted as Silver

04/01/2024

Tennessee
 Motor Vehicle Dept.
 Antioch, TN
 Title #91344613

Registration issued or renewed
 - Vehicle color noted as Silver

01/24/2025

257,027

Oliver Brothers Transmissions-
 Bryan
 Bryan, TX
 979-822-7878
 oliverbrotransmissions.com/inde
 x.html



Vehicle serviced
 - Computer(s) checked

05/15/2025

Tennessee
 Motor Vehicle Dept.
 Antioch, TN
 Title #91344613

Registration issued or renewed
 - Vehicle color noted as Silver

Have Questions? Consumers, please visit our Help Center at www.carfax.com. Dealers or Subscribers, please visit our Help Center at www.carfaxonline.com.

CARFAX Glossary

Accident Indicator

CARFAX receives information about accidents in all 50 states, the District of Columbia and Canada.

Not every accident is reported to CARFAX. As details about the accident become available, those additional details are added to the CARFAX Vehicle History Report. CARFAX recommends that you have this vehicle inspected by a qualified mechanic.

- According to the National Safety Council, Injury Facts, 2021 edition, 5% of the 276 million registered vehicles in the U.S. were involved in an accident in 2019. Over 77% of these were considered minor or moderate.
- This CARFAX Vehicle History Report is based only on information supplied to CARFAX and available as of 5/28/26 at 11:10:35 AM (CDT). Other information about this vehicle, including problems, may not have been reported to CARFAX. Use this report as one important tool, along with a vehicle inspection and test drive, to make a better decision about your next used car.

Airbag Deployment

Occurs when the driver, passenger or side airbag has been used or deployed during a crash or other incident. If an airbag has been deployed, it must be replaced by a qualified technician. Have this car inspected by a mechanic prior to purchase.

Damage Severity

Damage events result in one of the following severity levels:

- Minor: Generally, minor damage is cosmetic (including dents or scratches), may only require reconditioning, and typically does not compromise a vehicle's operation and/or safety.
- Moderate: Moderate damage may affect multiple components of the vehicle and may impair the vehicle's operation and/or safety.
- Severe: Severe damage usually affects multiple components of the vehicle and is likely to compromise the vehicle's operation and/or safety.

CARFAX recommends getting a pre-purchase inspection at a certified collision repair facility.

Failed Emissions Inspection

The emissions check performed during a vehicle inspection indicated the vehicle was emitting more than allowable emissions standards and/or had missing or modified parts. Repeated failed emissions records can indicate engine problems and CARFAX recommends you have the vehicle inspected.

First Owner

When the first owner(s) obtains a title from a Department of Motor Vehicles as proof of ownership.

New Owner Reported

When a vehicle is sold to a new owner, the Title must be transferred to the new owner(s) at a Department of Motor Vehicles.

Ownership History



CARFAX defines an owner as an individual or business that possesses and uses a vehicle. Not all title transactions represent changes in ownership. To provide estimated number of owners, CARFAX proprietary technology analyzes all the events in a vehicle history. Estimated ownership is available for vehicles manufactured after 1991 and titled solely in the US including Puerto Rico. Dealers sometimes opt to take ownership of a vehicle and are required to in the following states: Maine, Massachusetts, New Jersey, Ohio, Oklahoma, Pennsylvania and South Dakota. Please consider this as you review a vehicle's estimated ownership history.

Title Issued

A state issues a title to provide a vehicle owner with proof of ownership. Each title has a unique number. Each title or registration record on a CARFAX report does not necessarily indicate a change in ownership. In Canada, a registration and bill of sale are used as proof of ownership.

Toyota Recall / Service Campaign

Portions of this report have been included under license from Toyota Motor North America, Inc. ("TOYOTA"), License Agreement TMS1013 . This data applies only to vehicle marketed or originally sold in Mexico and the United States of America, including Guam, Saipan, American Samoa, Puerto Rico, the U.S. Virgin Islands and the other United States territories and protectorates with currently open safety or emissions recalls, or service campaigns. While TOYOTA provides data to Carfax Inc. on a regular basis, this report may not include very recent activity. For the manufacturer's most current information on recall/campaign activity for any Toyota, Lexus or Scion brand vehicle, you must go to <http://toyota.com/recall> or <http://lexus.com/recall>.

Follow Us:  facebook.com/CARFAX  [@CARFAXinc](https://twitter.com/CARFAXinc)  [About CARFAX](#)

CARFAX DEPENDS ON ITS SOURCES FOR THE ACCURACY AND RELIABILITY OF ITS INFORMATION. THEREFORE, NO RESPONSIBILITY IS ASSUMED BY CARFAX OR ITS AGENTS FOR ERRORS OR OMISSIONS IN THIS REPORT. CARFAX FURTHER EXPRESSLY DISCLAIMS ALL WARRANTIES, EXPRESS OR IMPLIED, INCLUDING ANY IMPLIED WARRANTIES OF MERCHANTABILITY OR FITNESS FOR A PARTICULAR PURPOSE.

© 2026 CARFAX, Inc., part of S&P Global. All rights reserved.
5/28/26 11:10:35 AM (CDT)

I have reviewed and received a copy of the CARFAX Vehicle History Report for this 2002 TOYOTA 4RUNNER vehicle (VIN: JT3GN86R520255187), which is based on information supplied to CARFAX and available as of 5/28/26 at 12:10 PM (EDT).

Customer Signature

Date

Dealer Signature

Date