



Report

US \$44.99

2016 Ford Transit Connect XLT

89,860 mi | VIN: NM0LS7F72G1230516 |

Cargo Van | 2.5L I4 F DOHC 16V | Gasoline | Front wheel drive

CARFAX HAS THE MOST ACCIDENT & DAMAGE INFORMATION



ACCIDENT Minor Damage

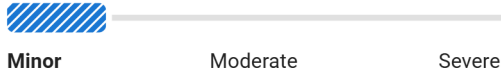

CARFAX VALUE \$12,350

21 Service History Records

At Least 1 Open Recall

4 Previous Owners

Types of Owners: Commercial, Personal

Last Owned in Michigan

This CARFAX Vehicle History Report is based only on information supplied to CARFAX and available as of 5/27/26 at 9:42:44 AM (CDT). Other information about this vehicle, including problems, may not have been reported to CARFAX. Use this report as one important tool, along with a vehicle inspection and test drive, to make a better decision about your next used car.



Accident / Damage History

Not all accidents / issues are reported to CARFAX

Event 1

06/29/2017

Accident reported: minor damage

- Vehicle involved in a rear-end collision with another motor vehicle
- Airbags did not deploy

Damage Severity Scale

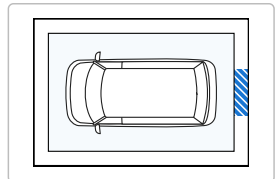
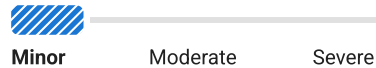

History-Based Value Report

\$12,350

CARFAX Retail Value

History events affecting this vehicle's value

Service History

Open Recall

↓ 🚗 Minor Damage

CARFAX Additional History Not all accidents / issues are reported to CARFAX	👤 Owners 1-2	👤 Owner 3	👤 Owner 4
Total Loss No total loss reported to CARFAX.	✔️ No Issues Reported	✔️ No Issues Reported	✔️ No Issues Reported
Structural Damage CARFAX recommends that you have this vehicle inspected by a collision repair specialist.	✔️ No Issues Reported	✔️ No Issues Reported	✔️ No Issues Reported
Airbag Deployment No airbag deployment reported to CARFAX.	✔️ No Issues Reported	✔️ No Issues Reported	✔️ No Issues Reported
Odometer Check No indication of an odometer rollback.	✔️ No Issues Indicated	✔️ No Issues Indicated	✔️ No Issues Indicated
Accident / Damage Accident reported: 06/29/2017.	Minor Damage	No New Issues Reported	No New Issues Reported
Manufacturer Recall At least 1 manufacturer recall requires service. Locate an authorized Ford or Lincoln Mercury dealer or call 866-436-7332 to obtain more information about this recall.	Recall Reported	No New Recalls Reported	No New Recalls Reported
Basic Warranty Original warranty estimated to have expired.	Warranty Expired	Warranty Expired	Warranty Expired









CARFAX Title History CARFAX guarantees the information in this section	👤 Owners 1-2	👤 Owner 3	👤 Owner 4
Damage Brands Salvage Junk Rebuilt Fire Flood Hail Lemon	✔️ Guaranteed No Problem	✔️ Guaranteed No Problem	✔️ Guaranteed No Problem
Odometer Brands Not Actual Mileage Exceeds Mechanical Limits	✔️ Guaranteed No Problem	✔️ Guaranteed No Problem	✔️ Guaranteed No Problem

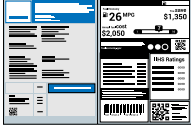

GUARANTEED - None of these title problems were reported by a U.S. state Department of Motor Vehicles (DMV). If you find that any of these title problems were reported by a DMV and not included in this report, you may qualify. [View Terms](#) | [View Certificate](#)

CARFAX Ownership History The number of owners is estimated	👤 Owners 1-2	👤 Owner 3	👤 Owner 4
Year purchased	2015	2024	2026
Type of owner	See Details	Personal	Personal
Estimated length of ownership	8 yrs. 6 mo.	1 yr. 10 mo.	3 months
Owned in the following states/provinces	See Details	Wisconsin	Michigan
Estimated miles driven per year	See Details	---	---
Last reported odometer reading	81,503	89,473	89,860



CARFAX Detailed History			
👤 Owner 1 Purchased: 2015	<div style="border: 1px solid blue; padding: 5px;"> Low mileage! This owner drove less than the industry average of 15,000 miles per year. </div>		Commercial Vehicle 12,019 mi/yr
Date	Mileage	Source	Comments

Not Reported		Ford Motor Company		Vehicle manufactured and shipped to original dealer Original Window Sticker 
08/31/2015		Illinois Motor Vehicle Dept.		Vehicle purchase reported - Titled or registered as commercial vehicle
09/08/2015	10	Illinois Motor Vehicle Dept. Lombard, IL Title #152516963970		Title issued or updated - Registration issued or renewed - First owner reported - Loan or lien reported - Vehicle color noted as White
11/23/2015		Al Piemonte Ford Melrose Park, IL 708-345-9300 apford.com ★ 2.6 / 5.0 8 Verified Reviews		Vehicle serviced - Pre-delivery inspection completed
06/10/2016		Illinois Motor Vehicle Dept. Lombard, IL		Registration issued or renewed
07/18/2016	9,042	Service Facility Atlanta, GA		Vehicle serviced - Oil and filter changed
11/30/2016	15,418	Service Facility Atlanta, GA		Vehicle serviced - Oil and filter changed
01/26/2017	17,949	Service Facility Atlanta, GA		Vehicle serviced - Tire(s) balanced - Tire(s) replaced
05/31/2017	22,851	Service Facility Atlanta, GA		Vehicle serviced - Four wheel alignment performed - Oil and filter changed - Tire condition and pressure checked - Tire pressure monitoring system serviced - Tire(s) balanced - Tire(s) replaced
06/13/2017		Illinois Motor Vehicle Dept. Lombard, IL		Registration issued or renewed - Correction to record
06/20/2017	23,779	Service Facility Atlanta, GA		Vehicle serviced
06/29/2017		Damage Report		Accident reported: minor damage - Vehicle involved in a rear-end collision with another motor vehicle - Damage to rear - Airbags did not deploy
<div data-bbox="850 1640 1256 1793" data-label="Figure"> <p>Damage Severity Scale</p>  <p>Minor Moderate Severe</p> </div>				

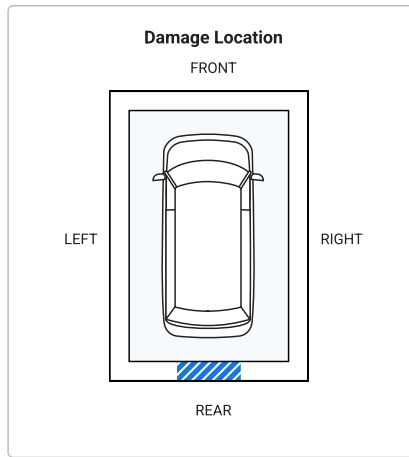
**CARFAX HAS THE MOST
ACCIDENT & DAMAGE
INFORMATION**









Minor damage is usually cosmetic, including dents or scratches to the vehicle body.







09/19/2017	24,697	Auto Auction	Vehicle sold
<p>Millions of used vehicles are bought and sold at auction every year.</p>			
09/19/2017		Fleet Management Co.	Vehicle sold in Georgia
11/01/2017		Gordie Boucher Lincoln Milwaukee, WI 414-327-6000 boucherlincoln.com ★ 4.7 / 5.0 196 Verified Reviews ♥ 86 Customer Favorites	Vehicle offered for sale
11/09/2017		Gordie Boucher Lincoln Milwaukee, WI 414-327-6000 boucherlincoln.com ★ 4.7 / 5.0 196 Verified Reviews ♥ 86 Customer Favorites	 Vehicle serviced - Recommended maintenance performed - Air filter replaced - Brakes checked - Electrical system checked - Safety inspection performed - Tire(s) balanced - Tires rotated
<p>Looks like this dealer serviced the car in order to prepare it for sale. That's a good thing!</p>			
11/20/2017		Gordie Boucher Lincoln Milwaukee, WI 414-327-6000 boucherlincoln.com ★ 4.7 / 5.0 196 Verified Reviews ♥ 86 Customer Favorites	 Vehicle serviced - Trim checked
12/30/2017	24,790	Gordie Boucher Lincoln Milwaukee, WI 414-327-6000 boucherlincoln.com ★ 4.7 / 5.0 196 Verified Reviews ♥ 86 Customer Favorites	Vehicle sold
01/02/2018		Wisconsin Motor Vehicle Dept. Milwaukee, WI	Registration issued or renewed - Vehicle color noted as White

 **Owner 2**
Purchased: 2018

Low mileage! This owner drove less than the industry average of 15,000 miles per year.

Personal Vehicle
10,858 mi/yr

Date	Mileage	Source		Comments
01/02/2018		Wisconsin Motor Vehicle Dept. Milwaukee, WI Title #18002C0390034		Title issued or updated - New owner reported - Vehicle color noted as White
06/26/2018	34,857	Midas West Allis, WI 414-257-1590 midas.com ★ 4.6 / 5.0 108 Verified Reviews ♥ 26 Customer Favorites		Vehicle serviced - Oil and filter changed
11/07/2018		Wisconsin Motor Vehicle Dept. Milwaukee, WI		Registration issued or renewed - Vehicle color noted as White
11/14/2019		Wisconsin Motor Vehicle Dept. Milwaukee, WI		Registration issued or renewed - Vehicle color noted as White
03/10/2020	48,016	Bob Sight Ford, Inc. Lees Summit, MO 816-524-6550 bobsightford.com ★ 4.8 / 5.0 727 Verified Reviews ♥ 731 Customer Favorites		Vehicle serviced - Maintenance inspection completed - Antifreeze/coolant checked - Battery/charging system checked - Brakes checked - Drivability/performance checked - Maintenance reminder reset - Oil and filter changed - Oxygen sensor replaced - Tire condition and pressure checked - Tires rotated
07/02/2020	49,758	Texas Inspection Station		Passed safety inspection
07/16/2020		Texas Motor Vehicle Dept. San Antonio, TX Title #01540544026155309		Title issued or updated - Registration issued or renewed - Passed safety inspection - Vehicle color noted as White
08/14/2020	53,741	Valvoline Instant Oil Change San Antonio, TX 210-680-2767 vioc.com ★ 4.8 / 5.0 423 Verified Reviews ♥ 220 Customer Favorites		Vehicle serviced - Air filter replaced - Oil and filter changed
11/25/2020	61,186	Ron Carter Ford Arvin Alvin, TX 281-331-8111 roncarterford.net ★ 4.2 / 5.0 330 Verified Reviews ♥ 1,868 Customer Favorites		Vehicle serviced - Maintenance inspection completed - Air filter replaced - Cabin air filter replaced/cleaned - Oil and filter changed
12/07/2020	61,243	Ron Carter Ford Arvin Alvin, TX 281-331-8111 roncarterford.net ★ 4.2 / 5.0 330 Verified Reviews ♥ 1,868 Customer Favorites		Vehicle serviced - Maintenance inspection completed
06/06/2021	64,096	Elite Carwash & Auto Repair Houston, TX 281-280-9400 elite-autogroup.com ★ 4.4 / 5.0 207 Verified Reviews ♥ 12 Customer Favorites		Vehicle serviced - Fluids checked - Vehicle washed/detailed

06/11/2021	64,146	Take 5 Oil Change Webster, TX (281) 332-9600 https://www.take5.com/ ★ 4.6 / 5.0 269 Verified Reviews ♥ 3,359 Customer Favorites		Vehicle serviced - Emission system checked - Emissions inspection performed - Safety inspection performed
06/11/2021		Texas Inspection Station Milwaukee, WI		Passed emissions inspection
07/01/2021		Texas Motor Vehicle Dept. San Antonio, TX Title #01540544026155309		Registration issued or renewed - Passed safety inspection - Vehicle color noted as White
08/16/2021	67,324	Valvoline Instant Oil Change New Braunfels, TX 830-515-5488 vioc.com ★ 4.8 / 5.0 313 Verified Reviews ♥ 4 Customer Favorites		Vehicle serviced - Oil and filter changed
08/31/2021	68,557	Bluebonnet Ford Lincoln New Braunfels, TX 830-606-8011 bbmotors.com ★ 4.7 / 5.0 3,410 Verified Reviews ♥ 26,144 Customer Favorites		Vehicle serviced - Maintenance inspection completed
09/29/2021	70,828	Bluebonnet Ford Lincoln New Braunfels, TX 830-606-8011 bbmotors.com ★ 4.7 / 5.0 3,410 Verified Reviews ♥ 26,144 Customer Favorites		Vehicle serviced - Maintenance inspection completed - Battery/charging system checked - Brakes checked - Induction system serviced - Oil and filter changed - Shifter cable replaced - Tire condition and pressure checked - Tires rotated
12/13/2021	76,244	Bluebonnet Ford Lincoln New Braunfels, TX 830-606-8011 bbmotors.com ★ 4.7 / 5.0 3,410 Verified Reviews ♥ 26,144 Customer Favorites		Vehicle serviced - Maintenance inspection completed - Antifreeze/coolant flushed/changed - Battery/charging system checked - Brakes checked - Tire condition and pressure checked - Tire(s) balanced - Tire(s) mounted - Tire(s) replaced - Tires rotated - Transmission fluid flushed
06/23/2022	79,815	Elite Carwash & Auto Repair Houston, TX 281-280-9400 elite-autogroup.com ★ 4.4 / 5.0 207 Verified Reviews ♥ 12 Customer Favorites		Vehicle serviced - Emissions inspection performed - Safety inspection performed
06/23/2022		Texas Inspection Station Milwaukee, WI		Passed emissions inspection
07/01/2022		Texas Motor Vehicle Dept. San Antonio, TX Title #01540544026155309		Registration issued or renewed - Passed safety inspection - Vehicle color noted as White
10/11/2022	81,503	Take 5 Oil Change Webster, TX (281) 332-9600		Vehicle serviced - Oil and filter changed

<https://www.take5.com/>

★ 4.6 / 5.0 269 Verified Reviews

♥ 3,359 Customer Favorites

07/25/2023

Ford Motor Company

Manufacturer Safety recall issued

- NHTSA #23V502
- Recall #23S36 LEFT AND RIGHT FRONT DOOR LATCH REPLACEMENT
- Status: Remedy Available

Locate an authorized Ford or Lincoln dealer or call 866-436-7332 to obtain more information

🔍 [Learn more about this recall](#)

Description: ON YOUR VEHICLE, IT MAY BE POSSIBLE FOR THE PAWL SPRING TAB INSIDE ONE OR MORE OF THE FRONT DOOR LATCHES TO BREAK. THIS CONDITION WILL TYPICALLY PREVENT THE DOOR FROM LATCHING. IN CERTAIN SITUATIONS, WHERE THE DOOR IS ABLE TO BE CLOSED, THE DOOR MAY UNLATCH WHILE DRIVING.

IF YOU ARE ABLE TO LATCH THE DOOR AFTER REPEATED ATTEMPTS TO SHUT THE DOOR, THE DOOR MAY POTENTIALLY UNLATCH WHILE DRIVING, INCREASING THE RISK OF INJURY.

Remedy: PARTS ARE NOW AVAILABLE TO REPAIR YOUR VEHICLE. FORD MOTOR COMPANY HAS AUTHORIZED YOUR DEALER TO REPLACE THE FRONT LEFT AND RIGHT DOOR LATCHES, FREE OF CHARGE PARTS AND LABOR. PLEASE CALL YOUR DEALER WITHOUT DELAY AND REQUEST A SERVICE DATE FOR RECALL 23S36. PROVIDE THE DEALER WITH YOUR VIN, WHICH IS PRINTED NEAR YOUR NAME AT THE BEGINNING OF THIS LETTER. FORD HAS NOT ISSUED INSTRUCTIONS TO STOP DRIVING YOUR VEHICLE UNDER THIS SAFETY RECALL. YOU SHOULD CONTACT YOUR DEALER FOR AN APPOINTMENT TO HAVE YOUR VEHICLE REMEDIED AS SOON AS PRACTICABLE.

👤 **Owner 3**
Purchased: 2024

Personal Vehicle

Date	Mileage	Source	Comments
03/28/2024	89,473	Wisconsin Motor Vehicle Dept. Milwaukee, WI	Odometer reading reported
04/10/2024		Wisconsin Motor Vehicle Dept. Milwaukee, WI Title #24101U90066	Title issued or updated - Registration issued or renewed - New owner reported - Vehicle color noted as White

👤 **Owner 4**
Purchased: 2026

Personal Vehicle

Date	Mileage	Source	Comments
02/27/2026		Michigan Motor Vehicle Dept.	Vehicle purchase reported
05/19/2026	89,860	Michigan Motor Vehicle Dept. Kalamazoo, MI Title #MI0030027964	Title issued or updated - New owner reported

Have Questions? Consumers, please visit our Help Center at www.carfax.com. Dealers or Subscribers, please visit our Help Center at www.carfaxonline.com.

CARFAX Glossary

Accident Indicator

CARFAX receives information about accidents in all 50 states, the District of Columbia and Canada.

Not every accident is reported to CARFAX. As details about the accident become available, those additional details are added to the CARFAX Vehicle History Report. CARFAX recommends that you have this vehicle inspected by a qualified mechanic.

- According to the National Safety Council, Injury Facts, 2021 edition, 5% of the 276 million registered vehicles in the U.S. were involved in an accident in 2019. Over 77% of these were considered minor or moderate.
- This CARFAX Vehicle History Report is based only on information supplied to CARFAX and available as of 5/27/26 at 9:42:44 AM (CDT). Other information about this vehicle, including problems, may not have been reported to CARFAX. Use this report as one important tool, along with a vehicle inspection and test drive, to make a better decision about your next used car.

Commercial

Vehicle was registered for business purposes.

Damage Severity

Damage events result in one of the following severity levels:

- Minor: Generally, minor damage is cosmetic (including dents or scratches), may only require reconditioning, and typically does not compromise a vehicle's operation and/or safety.
- Moderate: Moderate damage may affect multiple components of the vehicle and may impair the vehicle's operation and/or safety.
- Severe: Severe damage usually affects multiple components of the vehicle and is likely to compromise the vehicle's operation and/or safety.

CARFAX recommends getting a pre-purchase inspection at a certified collision repair facility.

First Owner

When the first owner(s) obtains a title from a Department of Motor Vehicles as proof of ownership.

Ford or Lincoln Mercury Recall

The Ford Motor Company provides CARFAX with Field Service Action and recall information regarding safety, compliance and emissions programs announced since 2000 for a specific vehicle. For complete information regarding programs or concerns about this vehicle, please contact a local Ford or Lincoln Mercury Dealer.

Manufacturer Recall

Automobile manufacturers issue recall notices to inform vehicle owners of a safety defect or failure to meet minimum federal safety or emissions standards. Manufacturer recalls are repaired at no cost to the customer.

New Owner Reported

When a vehicle is sold to a new owner, the Title must be transferred to the new owner(s) at a Department of Motor Vehicles.

Ownership History

CARFAX defines an owner as an individual or business that possesses and uses a vehicle. Not all title transactions represent changes in ownership. To provide estimated number of owners, CARFAX proprietary technology analyzes all the events in a vehicle history. Estimated ownership is available for vehicles manufactured after 1991 and titled solely in the US including Puerto Rico. Dealers sometimes opt to take ownership of a vehicle and are required to in the following states: Maine, Massachusetts, New Jersey, Ohio, Oklahoma, Pennsylvania and South Dakota. Please consider this as you review a vehicle's estimated ownership history.

Title Issued

A state issues a title to provide a vehicle owner with proof of ownership. Each title has a unique number. Each title or registration record on a CARFAX report does not necessarily indicate a change in ownership. In Canada, a registration and bill of sale are used as proof of ownership.

Follow Us:  facebook.com/CARFAX  [@CARFAXinc](https://twitter.com/CARFAXinc)  [About CARFAX](#)

CARFAX DEPENDS ON ITS SOURCES FOR THE ACCURACY AND RELIABILITY OF ITS INFORMATION. THEREFORE, NO RESPONSIBILITY IS ASSUMED BY CARFAX OR ITS AGENTS FOR ERRORS OR OMISSIONS IN THIS REPORT. CARFAX FURTHER EXPRESSLY DISCLAIMS ALL WARRANTIES, EXPRESS OR IMPLIED, INCLUDING ANY IMPLIED WARRANTIES OF MERCHANTABILITY OR FITNESS FOR A PARTICULAR PURPOSE.

© 2026 CARFAX, Inc., part of S&P Global. All rights reserved.
5/27/26 9:42:44 AM (CDT)

I have reviewed and received a copy of the CARFAX Vehicle History Report for this 2016 FORD TRANSIT CONNECT vehicle (VIN: NM0LS7F72G1230516), which is based on information supplied to CARFAX and available as of 5/27/26 at 10:42 AM (EDT).

Customer Signature

Date

Dealer Signature

Date