



History-Based Value Report

\$4,850

CARFAX Retail Value

History events affecting this vehicle's value

- 1-Owner Vehicle
- Service History
- Personal Vehicle
- Minor Damage



Vehicle History Report™

US \$44.99

2002 FORD FOCUS LX

VIN: 1FAFP33P12W281926
 SEDAN 4 DR
 2.0L I4 F SOHC 8V
 GASOLINE
 FRONT WHEEL DRIVE

Accident reported: minor damage

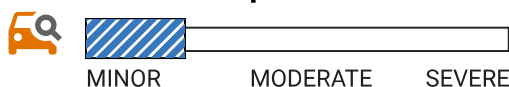

40 Service history records

CARFAX 1-Owner vehicle

Personal vehicle

84,167 Last reported odometer reading



This CARFAX Vehicle History Report is based only on information supplied to CARFAX and available as of 10/19/24 at 7:24:36 AM (CDT). Other information about this vehicle, including problems, may not have been reported to CARFAX. Use this report as one important tool, along with a vehicle inspection and test drive, to make a better decision about your next used car.



Accident / Damage History

Not all accidents / issues are reported to CARFAX

Event 1

11/03/2014

**Accident reported:
minor damage with
another motor vehicle**

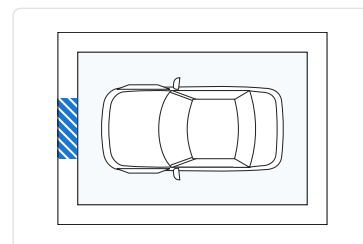
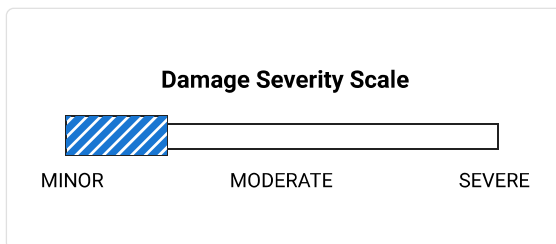

Event 2

11/20/2014

**Accident reported:
minor damage with
another motor vehicle**

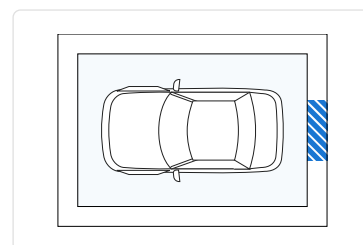
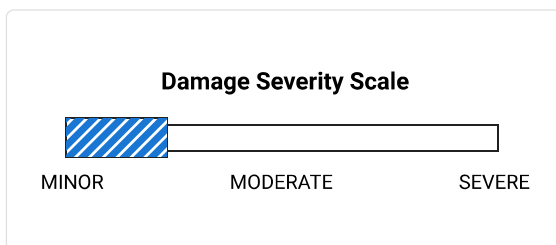

Event 3

05/24/2019

**Accident reported:
minor damage with
another motor vehicle**

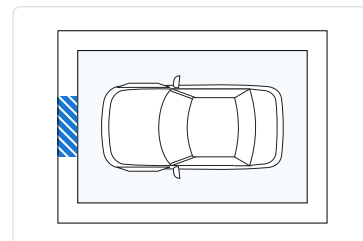
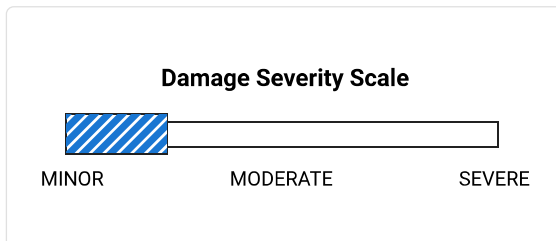

Additional History

Not all accidents / issues are reported to CARFAX

Owner 1

Total Loss

No total loss reported to CARFAX.

No Issues Reported

<p>Structural Damage CARFAX recommends that you have this vehicle inspected by a collision repair specialist.</p>	<p>✓ No Issues Reported</p>
<p>Airbag Deployment No airbag deployment reported to CARFAX.</p>	<p>✓ No Issues Reported</p>
<p>Odometer Check No indication of an odometer rollback.</p>	<p>✓ No Issues Indicated</p>
<p>Accident / Damage Accidents reported: 11/03/2014, 11/20/2014, and 05/24/2019.</p>	<p>Minor Damage</p>
<p>Manufacturer Recall No open recalls reported to CARFAX. A current list of recalls is available at Ford Motor Company.</p>	<p>✓ No Recalls Reported</p>
<p>Basic Warranty Original warranty estimated to have expired.</p>	<p>Warranty Expired</p>

<p>CARFAX Title History</p>	<p>Owner 1</p>
<p>Damage Brands Salvage Junk Rebuilt Fire Flood Hail Lemon</p>	<p>No Problem</p>
<p>Odometer Brands Not Actual Mileage Exceeds Mechanical Limits</p>	<p>No Problem</p>

<p>CARFAX Ownership History The number of owners is estimated</p>	<p>Owner 1</p>
<p>Year purchased</p>	<p>2002</p>
<p>Type of owner</p>	<p>Personal</p>
<p>Estimated length of ownership</p>	<p>21 yrs. 10 mo.</p>
<p>Owned in the following states/provinces</p>	<p>Michigan</p>
<p>Estimated miles driven per year</p>	<p>3,885/yr</p>
<p>Last reported odometer reading</p>	<p>84,167</p>



<p>CARFAX Detailed History</p>















Owner 1
Purchased: 2002















Low mileage! This owner drove less than the industry average of 15,000 miles per year.





Personal Vehicle
3,885 mi/yr



Date	Mileage	Source	Comments
04/17/2002		NICB	Vehicle manufactured and shipped to original dealer
04/22/2002	1	Service Facility	 Vehicle serviced Pre-delivery inspection completed
12/18/2002	40	Michigan Motor Vehicle Dept. Muskegon, MI Title #257N3520054	Title or registration issued First owner reported Titled or registered as personal vehicle
02/18/2003	1,221	Redeker Ford Grand Haven, MI 616-842-0600 redekerfordsales.com	 Vehicle serviced Oil and filter changed Tires rotated
02/19/2003		Preferred Ford Grand Haven, MI 616-842-0600 preferredford.com ★ 4.5 / 5.0 245 Verified Reviews ❤️ 554 Customer Favorites	 Vehicle serviced
02/27/2003	1,437	Redeker Ford Grand Haven, MI 616-842-0600 redekerfordsales.com	 Vehicle serviced Washer fluid reservoir replaced
03/15/2003		Preferred Ford Grand Haven, MI 616-842-0600 preferredford.com ★ 4.5 / 5.0 245 Verified Reviews ❤️ 554 Customer Favorites	 Vehicle serviced
03/24/2003	1,951	Preferred Ford Grand Haven, MI 616-842-0600 preferredford.com ★ 4.5 / 5.0 245 Verified Reviews ❤️ 554 Customer Favorites	 Vehicle serviced

04/25/2003	2,619	Preferred Ford Grand Haven, MI 616-842-0600 preferredford.com ★ 4.5 / 5.0 245 Verified Reviews ♥ 554 Customer Favorites		Vehicle serviced
05/23/2003	3,079	Redeker Ford Grand Haven, MI 616-842-0600 redekerfordsales.com		Vehicle serviced Oil and filter changed Tires rotated
05/23/2003		Preferred Ford Grand Haven, MI 616-842-0600 preferredford.com ★ 4.5 / 5.0 245 Verified Reviews ♥ 554 Customer Favorites		Vehicle serviced
09/10/2003	5,348	Redeker Ford Grand Haven, MI 616-842-0600 redekerfordsales.com		Vehicle serviced Oil and filter changed Tires rotated
09/10/2003		Preferred Ford Grand Haven, MI 616-842-0600 preferredford.com ★ 4.5 / 5.0 245 Verified Reviews ♥ 554 Customer Favorites		Vehicle serviced
10/10/2003	5,846	Preferred Ford Grand Haven, MI 616-842-0600 preferredford.com ★ 4.5 / 5.0 245 Verified Reviews ♥ 554 Customer Favorites		Vehicle serviced
12/02/2003	6,770	Preferred Ford Grand Haven, MI 616-842-0600 preferredford.com ★ 4.5 / 5.0 245 Verified Reviews ♥ 554 Customer Favorites		Vehicle serviced

02/25/2004	8,454	Preferred Ford Grand Haven, MI 616-842-0600 preferredford.com ★ 4.5 / 5.0 245 Verified Reviews ❤️ 554 Customer Favorites		Vehicle serviced
06/07/2004	10,550	Preferred Ford Grand Haven, MI 616-842-0600 preferredford.com ★ 4.5 / 5.0 245 Verified Reviews ❤️ 554 Customer Favorites		Vehicle serviced
02/21/2005	15,114	Preferred Ford Grand Haven, MI 616-842-0600 preferredford.com ★ 4.5 / 5.0 245 Verified Reviews ❤️ 554 Customer Favorites		Vehicle serviced
05/07/2005	16,921	Preferred Ford Grand Haven, MI 616-842-0600 preferredford.com ★ 4.5 / 5.0 245 Verified Reviews ❤️ 554 Customer Favorites		Vehicle serviced
10/17/2005	19,286	Preferred Ford Grand Haven, MI 616-842-0600 preferredford.com ★ 4.5 / 5.0 245 Verified Reviews ❤️ 554 Customer Favorites		Vehicle serviced
01/16/2006	20,832	Preferred Ford Grand Haven, MI 616-842-0600 preferredford.com ★ 4.5 / 5.0 245 Verified Reviews ❤️ 554 Customer Favorites		Vehicle serviced

04/11/2006	22,424	Preferred Ford Grand Haven, MI 616-842-0600 preferredford.com ★ 4.5 / 5.0 245 Verified Reviews ♥ 554 Customer Favorites		Vehicle serviced
08/31/2006	24,897	Preferred Ford Grand Haven, MI 616-842-0600 preferredford.com ★ 4.5 / 5.0 245 Verified Reviews ♥ 554 Customer Favorites		Vehicle serviced Maintenance inspection completed Battery/charging system checked Brakes checked Tire condition and pressure checked
01/10/2007	26,958	Redeker Ford Grand Haven, MI 616-842-0600 redekerfordsales.com		Vehicle serviced Maintenance inspection completed Tires rotated Oil and filter changed
01/10/2007		Preferred Ford Grand Haven, MI 616-842-0600 preferredford.com ★ 4.5 / 5.0 245 Verified Reviews ♥ 554 Customer Favorites		Vehicle serviced Maintenance inspection completed Battery/charging system checked Brakes checked Tire condition and pressure checked
01/18/2007		Michigan Motor Vehicle Dept. Muskegon, MI		Registration issued or renewed
04/04/2007		Michigan Motor Vehicle Dept. Muskegon, MI		Registration issued or renewed
07/25/2007	29,851	Redeker Ford Grand Haven, MI 616-842-0600 redekerfordsales.com		Vehicle serviced Maintenance inspection completed Recommended maintenance performed
07/25/2007		Preferred Ford Grand Haven, MI 616-842-0600 preferredford.com ★ 4.5 / 5.0 245 Verified Reviews ♥ 554 Customer Favorites		Vehicle serviced Maintenance inspection completed Oil and filter changed Tires rotated

02/04/2008		Michigan Motor Vehicle Dept. Muskegon, MI		Registration issued or renewed
07/15/2008	33,604	Redeker Ford Grand Haven, MI 616-842-0600 redekerfordsales.com		Vehicle serviced Maintenance inspection completed Four tires balanced Fuel filter replaced Oil and filter changed
07/15/2008		Preferred Ford Grand Haven, MI 616-842-0600 preferredford.com ★ 4.5 / 5.0 245 Verified Reviews ❤️ 554 Customer Favorites		Vehicle serviced Maintenance inspection completed Four tires balanced
07/29/2008	33,736	Redeker Ford Grand Haven, MI 616-842-0600 redekerfordsales.com		Vehicle serviced Transmission serviced
07/29/2008		Preferred Ford Grand Haven, MI 616-842-0600 preferredford.com ★ 4.5 / 5.0 245 Verified Reviews ❤️ 554 Customer Favorites		Vehicle serviced
01/13/2009		Michigan Motor Vehicle Dept. Muskegon, MI		Registration issued or renewed
01/12/2010		Michigan Motor Vehicle Dept. Muskegon, MI		Registration issued or renewed
01/25/2011		Michigan Motor Vehicle Dept. Muskegon, MI		Registration issued or renewed
01/23/2012		Michigan Motor Vehicle Dept. Muskegon, MI		Registration issued or renewed
01/16/2013		Michigan Motor Vehicle Dept. Muskegon, MI		Registration issued or renewed

01/14/2014	Michigan Motor Vehicle Dept. Muskegon, MI		Registration issued or renewed
02/11/2014	Service Facility		Vehicle serviced Oil and filter changed Air filter checked
07/23/2014	Service Facility		Vehicle serviced Oil and filter changed Tires rotated

11/03/2014	Damage Report		Accident reported: minor damage with another motor vehicle Damage to front
------------	---------------	---	--



CARFAX HAS THE MOST ACCIDENT & DAMAGE INFORMATION



Damage Severity Scale

MINOR
MODERATE
SEVERE

Damage Location

FRONT

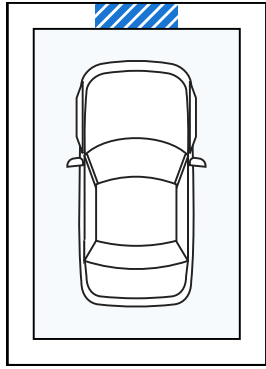

REAR

Minor damage is usually cosmetic, including dents or scratches to the vehicle body.



11/20/2014	Damage Report		Accident reported: minor damage with another motor vehicle Damage to rear
------------	---------------	---	---

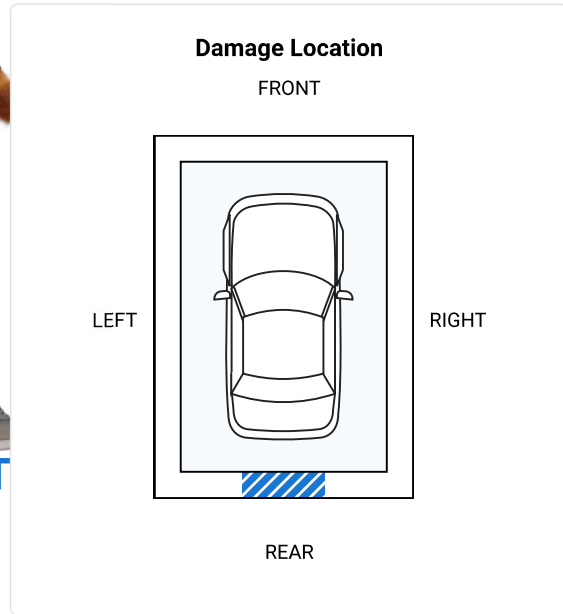
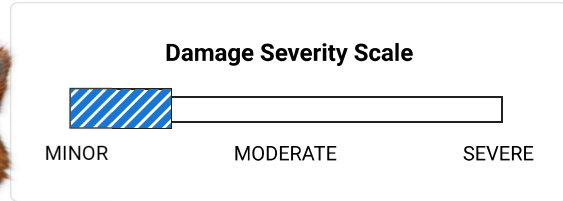

CARFAX HAS THE MOST ACCIDENT & DAMAGE INFORMATION



01/23/2015		Michigan Motor Vehicle Dept. Muskegon, MI		Registration issued or renewed
01/24/2015	59,160	Walmart Auto Care Center Muskegon, MI 231-739-6331 https:// www.walmart.com ★ 4.4 / 5.0 22 Verified Reviews		Vehicle serviced Tire repaired Tires rotated
01/21/2016		Michigan Motor Vehicle Dept. Muskegon, MI		Registration issued or renewed
12/11/2016	64,737	Walmart Auto Care Center Muskegon, MI 231-739-6331 https:// www.walmart.com ★ 4.4 / 5.0 22 Verified Reviews		Vehicle serviced Oil and filter changed



01/30/2017	Michigan Motor Vehicle Dept. Muskegon, MI	Registration issued or renewed
08/18/2017 66,825	Walmart Auto Care Center Muskegon, MI 231-739-6331 https://www.walmart.com ★ 4.4 / 5.0 22 Verified Reviews	 Vehicle serviced Tire(s) replaced Tire(s) balanced
02/06/2018	Michigan Motor Vehicle Dept. Muskegon, MI	Registration issued or renewed
09/17/2018 70,136	Walmart Auto Care Center Muskegon, MI 231-739-6331 https://www.walmart.com ★ 4.4 / 5.0 22 Verified Reviews	 Vehicle serviced Oil and filter changed Tires rotated
05/24/2019	Damage Report	 Accident reported: minor damage with another motor vehicle Damage to front

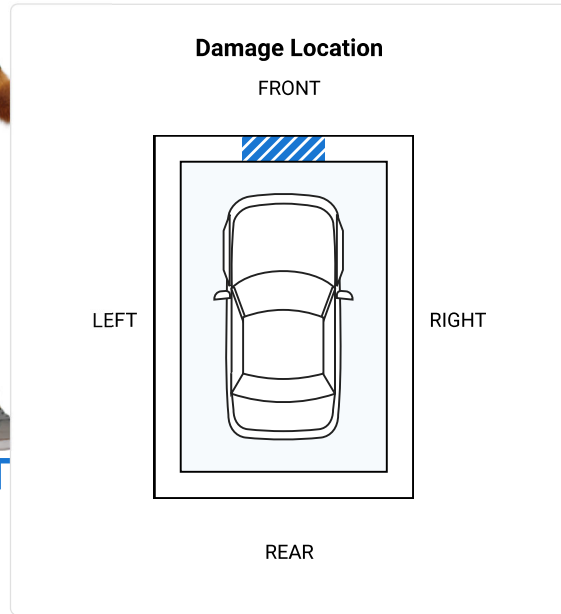
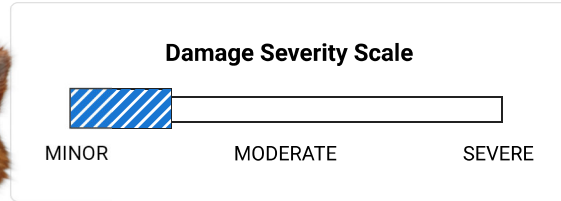

CARFAX HAS THE MOST ACCIDENT & DAMAGE INFORMATION



01/28/2020		Michigan Motor Vehicle Dept. Muskegon, MI		Registration issued or renewed
11/05/2020	76,958	Walmart Auto Care Center Muskegon, MI 231-739-6331 https:// www.walmart.com ★ 4.4 / 5.0 22 Verified Reviews		Vehicle serviced Tire(s) balanced Tires rotated Oil and filter changed
01/05/2021		Michigan Motor Vehicle Dept. Muskegon, MI		Registration issued or renewed
10/15/2021	78,349	The Garage MKG Muskegon, MI 231-559-0338 ★ 5.0 / 5.0 16 Verified Reviews ❤️ 144 Customer Favorites		Vehicle serviced Spark plug wires replaced Ignition system checked Fuel filter replaced Axle(s) replaced Spark plug(s) replaced Emissions system serviced Emission system checked Air filter replaced Front axle(s) replaced/repared

12/10/2021		Michigan Motor Vehicle Dept. Muskegon, MI		Registration issued or renewed
02/25/2022	79,218	The Garage MKG Muskegon, MI 231-559-0338 ★ 5.0 / 5.0 16 Verified Reviews ❤️ 144 Customer Favorites		Vehicle serviced Front axle(s) replaced/repaired Wheel bearing(s)/hub(s) replaced
12/09/2022		Michigan Motor Vehicle Dept. Muskegon, MI		Registration issued or renewed
04/15/2023	81,277	Walmart Auto Care Center Muskegon, MI 231-739-6331 https:// www.walmart.com ★ 4.4 / 5.0 22 Verified Reviews		Vehicle serviced Oil and filter changed
12/11/2023		Michigan Motor Vehicle Dept. Muskegon, MI		Registration issued or renewed
08/07/2024	84,167	Walmart Auto Care Center Muskegon, MI 231-739-6331 https:// www.walmart.com ★ 4.4 / 5.0 22 Verified Reviews		Vehicle serviced Oil and filter changed

Have Questions? Consumers, please visit our Help Center at www.carfax.com. Dealers or Subscribers, please visit our Help Center at www.carfaxonline.com.



Glossary

Accident Indicator

CARFAX receives information about accidents in all 50 states, the District of Columbia and Canada.

Not every accident is reported to CARFAX. As details about the accident become available, those additional details are added to the CARFAX Vehicle History Report. CARFAX recommends that you have this vehicle inspected by a qualified mechanic.

- According to the National Safety Council, Injury Facts, 2021 edition, 5% of the 276 million registered vehicles in the U.S. were involved in an accident in 2019. Over 77% of these were considered minor or moderate.

- This CARFAX Vehicle History Report is based only on information supplied to CARFAX and available as of 10/19/24 at 7:24:36 AM (CDT). Other information about this vehicle, including problems, may not have been reported to CARFAX. Use this report as one important tool, along with a vehicle inspection and test drive, to make a better decision about your next used car.

Damage Severity

Damage events result in one of the following severity levels:

- Minor: Generally, minor damage is cosmetic (including dents or scratches), may only require reconditioning, and typically does not compromise a vehicle's operation and/or safety.
- Moderate: Moderate damage may affect multiple components of the vehicle and may impair the vehicle's operation and/or safety.
- Severe: Severe damage usually affects multiple components of the vehicle and is likely to compromise the vehicle's operation and/or safety.

CARFAX recommends getting a pre-purchase inspection at a certified collision repair facility.

First Owner

When the first owner(s) obtains a title from a Department of Motor Vehicles as proof of ownership.

Ford or Lincoln Mercury Recall

The Ford Motor Company provides CARFAX with Field Service Action and recall information regarding safety, compliance and emissions programs announced since 2000 for a specific vehicle. For complete information regarding programs or concerns about this vehicle, please contact a local Ford or Lincoln Mercury Dealer.

Ownership History

CARFAX defines an owner as an individual or business that possesses and uses a vehicle. Not all title transactions represent changes in ownership. To provide estimated number of owners, CARFAX proprietary technology analyzes all the events in a vehicle history. Estimated ownership is available for vehicles manufactured after 1991 and titled solely in the US including Puerto Rico. Dealers sometimes opt to take ownership of a vehicle and are required to in the following states: Maine, Massachusetts, New Jersey, Ohio, Oklahoma, Pennsylvania and South Dakota. Please consider this as you review a vehicle's estimated ownership history.

Follow Us:  facebook.com/CARFAX  [@CARFAXinc](https://twitter.com/CARFAXinc)  [About CARFAX](#)

CARFAX DEPENDS ON ITS SOURCES FOR THE ACCURACY AND RELIABILITY OF ITS INFORMATION. THEREFORE, NO RESPONSIBILITY IS ASSUMED BY CARFAX OR ITS AGENTS FOR ERRORS OR OMISSIONS IN THIS REPORT. CARFAX FURTHER EXPRESSLY DISCLAIMS ALL WARRANTIES, EXPRESS OR IMPLIED, INCLUDING ANY IMPLIED WARRANTIES OF MERCHANTABILITY OR FITNESS FOR A PARTICULAR PURPOSE.

© 2024 CARFAX, Inc., part of S&P Global. All rights reserved.
10/19/24 7:24:36 AM (CDT)

I have reviewed and received a copy of the CARFAX Vehicle History Report for this 2002 FORD FOCUS vehicle (VIN: 1FAFP33P12W281926), which is based on information supplied to CARFAX and available as of 10/19/24 at 8:24 AM (EDT).

Customer Signature

Date

Dealer Signature

Date