



Vehicle History Report™

US \$44.99

1999 CHEVROLET SUBURBAN K1500 LS

VIN: 3GNFK16R6XG134010
4 DOOR WAGON/SPORT
UTILITY
5.7L V8 F OHV
GASOLINE
REAR WHEEL DRIVE W/ 4X4

Accident reported: minor damage

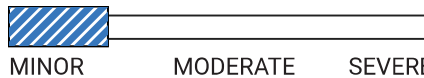

29 Service history records



3 Previous owners



Personal vehicle



287,046 Last reported odometer reading

This CARFAX Vehicle History Report is based only on information supplied to CARFAX and available as of 5/4/24 at 6:02:20 AM (CDT). Other information about this vehicle, including problems, may not have been reported to CARFAX. Use this report as one important tool, along with a vehicle inspection and test drive, to make a better decision about your next used car.



Accident / Damage History

Not all accidents / issues are reported to CARFAX

Event 1

01/04/2008

**Accident reported:
very minor damage**
- It hit an animal

Damage Severity Scale

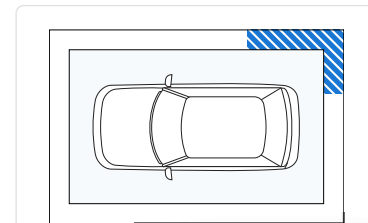
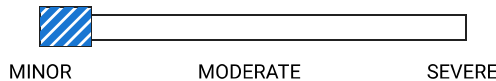

[^ Back To Top](#)

Event 2

03/26/2010

**Accident reported:
minor damage**
It hit an animal

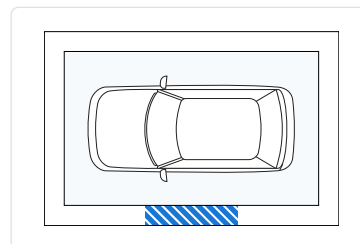
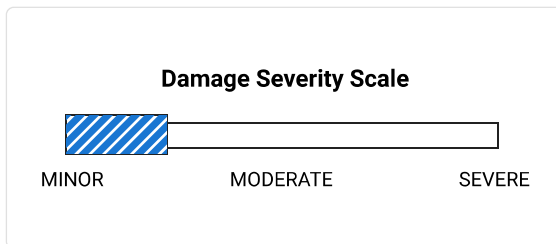

Event 3

01/29/2012

**Accident reported:
very minor damage
with another motor
vehicle**

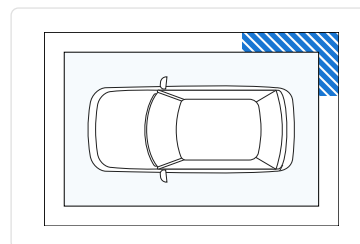
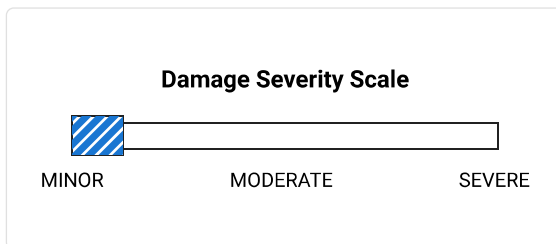

Additional History

Not all accidents / issues are reported to CARFAX

Owner 1

Owner 2

Owner 3

Total Loss

No total loss reported to CARFAX.

No Issues Reported

No Issues Reported

No Issues Reported

Structural Damage

CARFAX recommends that you have this vehicle inspected by a collision repair specialist.

No Issues Reported

No Issues Reported

No Issues Reported

Airbag Deployment

No airbag deployment reported to CARFAX.

No Issues Reported

No Issues Reported

No Issues Reported

Odometer Check

No indication of an odometer rollback.

No Issues Indicated

No Issues Indicated

No Issues Indicated

Accident / Damage

Accidents reported: 01/04/2008, 03/26/2010, and 01/29/2012.

No Issues Reported

No Issues Reported

Minor Damage

Manufacturer Recall

No open recalls reported to CARFAX. Check for open recalls on GM vehicles at recalls.gm.com.

No Recalls Reported

No Recalls Reported

No Recalls Reported

Basic Warranty

Original warranty estimated to have expired.

Warranty Expired

Warranty Expired

Warranty

[^ Back To Top](#)

 Title History	Owner 1	Owner 2	Owner 3
Damage Brands Salvage Junk Rebuilt Fire Flood Hail Lemon	No Problem	No Problem	No Problem
Odometer Brands Not Actual Mileage Exceeds Mechanical Limits	No Problem	No Problem	No Problem

 Ownership History The number of owners is estimated	Owner 1	Owner 2	Owner 3
Year purchased	1998	1999	2002
Type of owner	Personal	Personal	Personal
Estimated length of ownership	9 months	2 yrs. 11 mo.	22 years
Owned in the following states/provinces	Michigan	Michigan	Michigan
Estimated miles driven per year	---	---	15,814/yr
Last reported odometer reading	7,710	---	287,046

 Detailed History

 Owner 1 Purchased: 1998		Personal Vehicle	
Date	Mileage	Source	Comments
07/01/1998		US Customs	Vehicle exported from Mexico and imported to Jacksonville, FL
07/17/1998		Michigan Motor Vehicle Dept. Pontiac, MI Title #805J1980001	Title or registration issued First owner reported
11/03/1998	7,710	Michigan Motor Vehicle Dept. Belleville, MI Title #220J3070212	Title or registration issued Titled or registered as personal vehicle











 Owner 2 Purchased: 1999		Personal Vehicle
^ Back To Top		

Date	Mileage	Source	Comments
04/30/1999		Michigan Motor Vehicle Dept. Jackson, MI Title #220K1200490	Title or registration issued New owner reported











Owner 3
Purchased: 2002









Personal Vehicle
15,814 mi/yr

Date	Mileage	Source	Comments
04/08/2002	57,025	Michigan Motor Vehicle Dept. Webberville, MI Title #230N0980281	Title or registration issued New owner reported
05/13/2003	76,659	Service Facility	 Vehicle serviced
07/29/2003	80,298	Service Facility	 Vehicle serviced
09/26/2003	83,270	Service Facility	 Vehicle serviced
11/25/2003	86,309	Service Facility	 Vehicle serviced
11/25/2003		Waldecker Pontiac Buick Brighton, MI 810-227-1761 waldeckerauto.com	 Vehicle serviced Recommended maintenance performed Oil and filter changed
03/08/2004	89,841	Service Facility	 Vehicle serviced
03/08/2004		Waldecker Pontiac Buick Brighton, MI 810-227-1761 waldeckerauto.com	 Vehicle serviced Recommended maintenance performed Oil and filter changed
05/14/2004	92,953	Service Facility	 Vehicle serviced
05/14/2004		Waldecker Pontiac Buick Brighton, MI 810-227-1761 waldeckerauto.com	 Vehicle serviced Recommended maintenance performed Oil and filter changed
07/16/2004	96,315	Service Facility	 Vehicle serviced

[^ Back To Top](#)

07/16/2004		Waldecker Pontiac Buick Brighton, MI 810-227-1761 waldeckerauto.com		Vehicle serviced Recommended maintenance performed Oil and filter changed
09/16/2004	99,735	Service Facility		Vehicle serviced Maintenance inspection completed Recommended maintenance performed Steering/suspension lubricated Oil and filter changed
09/16/2004		Waldecker Pontiac Buick Brighton, MI 810-227-1761 waldeckerauto.com		Vehicle serviced Recommended maintenance performed Oil and filter changed
12/07/2004	102,671	Service Facility		Vehicle serviced Maintenance inspection completed Recommended maintenance performed Steering/suspension lubricated Oil and filter changed
12/07/2004		Waldecker Pontiac Buick Brighton, MI 810-227-1761 waldeckerauto.com		Vehicle serviced Recommended maintenance performed Oil and filter changed
02/02/2005	105,930	Service Facility		Vehicle serviced Maintenance inspection completed Recommended maintenance performed Steering/suspension lubricated Oil and filter changed
02/02/2005		Waldecker Pontiac Buick Brighton, MI 810-227-1761 waldeckerauto.com		Vehicle serviced Recommended maintenance performed Oil and filter changed
03/07/2005	109,134	Waldecker Pontiac Buick Brighton, MI 810-227-1761 waldeckerauto.com		Vehicle serviced Recommended maintenance performed Oil and filter changed
05/19/2005	112,797	Waldecker Pontiac Buick Brighton, MI 810-227-1761 waldeckerauto.com		Vehicle serviced Recommended maintenance performed Oil and filter changed

[^ Back To Top](#)

07/21/2005	116,126	Waldecker Pontiac Buick Brighton, MI 810-227-1761 waldeckerauto.com		Vehicle serviced Recommended maintenance performed Oil and filter changed
08/26/2005	119,259	Waldecker Pontiac Buick Brighton, MI 810-227-1761 waldeckerauto.com		Vehicle serviced Recommended maintenance performed Oil and filter changed
10/21/2005	122,621	Waldecker Pontiac Buick Brighton, MI 810-227-1761 waldeckerauto.com		Vehicle serviced Recommended maintenance performed Oil and filter changed
12/19/2005	126,111	Waldecker Pontiac Buick Brighton, MI 810-227-1761 waldeckerauto.com		Vehicle serviced Recommended maintenance performed Oil and filter changed
01/24/2006	129,194	Waldecker Pontiac Buick Brighton, MI 810-227-1761 waldeckerauto.com		Vehicle serviced Recommended maintenance performed Oil and filter changed
04/07/2006	132,325	Waldecker Pontiac Buick Brighton, MI 810-227-1761 waldeckerauto.com		Vehicle serviced Recommended maintenance performed Drive belts checked Oil and filter changed Body lubricated
06/15/2006	135,790	Waldecker Pontiac Buick Brighton, MI 810-227-1761 waldeckerauto.com		Vehicle serviced Recommended maintenance performed Drive belts checked Oil and filter changed Body lubricated
05/16/2007		Michigan Motor Vehicle Dept. Webberville, MI		Registration issued or renewed
01/04/2008		Damage Report		Accident reported: very minor damage It hit an animal Damage to right rear

[^ Back To Top](#)



CARFAX HAS THE MOST ACCIDENT & DAMAGE INFORMATION

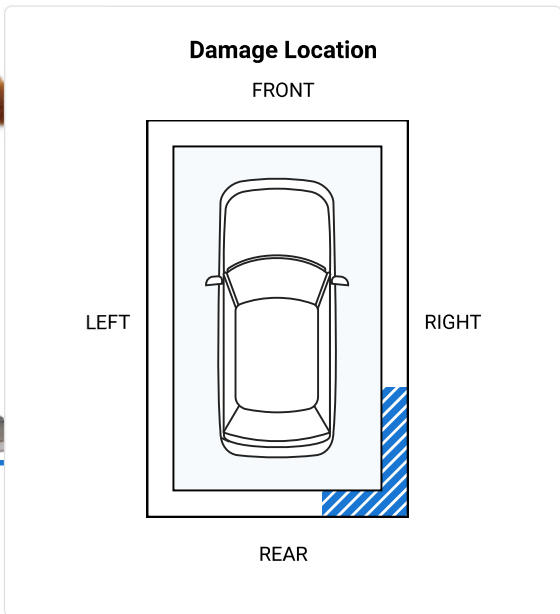
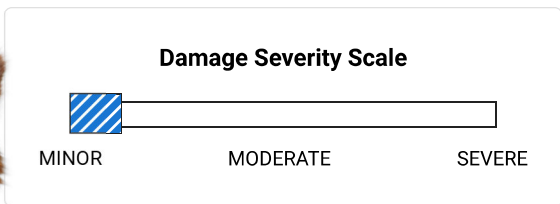

Minor damage is usually cosmetic, including dents or scratches to the vehicle body.



05/22/2008	Michigan Motor Vehicle Dept. Webberville, MI	Registration issued or renewed
04/29/2009	Michigan Motor Vehicle Dept. Webberville, MI	Registration issued or renewed
03/26/2010	Damage Report	 Accident reported: minor damage It hit an animal Damage to left side

[^ Back To Top](#)

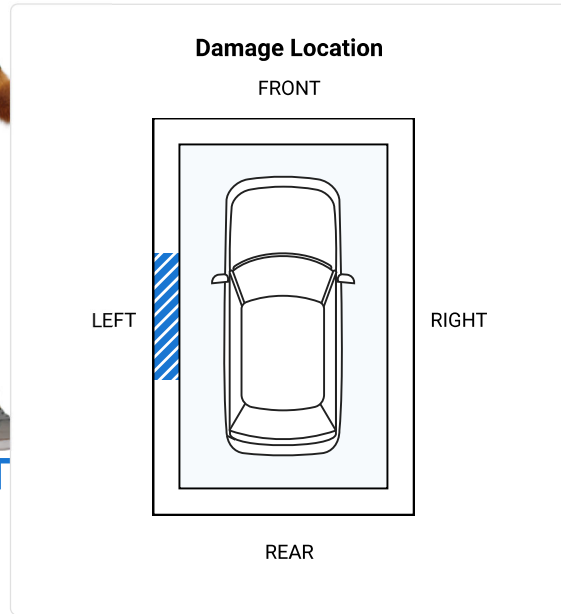
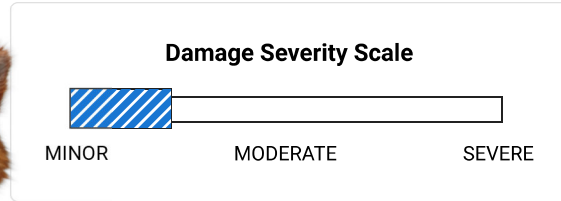

CARFAX HAS THE MOST ACCIDENT & DAMAGE INFORMATION



05/07/2010	Michigan Motor Vehicle Dept. Webberville, MI	Registration issued or renewed
02/25/2011 216,033	Waldecker Chevrolet Fowlerville, MI 517-223-9142 waldeckerauto.com	 Vehicle serviced Oil and filter changed
04/18/2011	Michigan Motor Vehicle Dept. Webberville, MI	Registration issued or renewed
01/29/2012	Damage Report	 Accident reported: very minor damage with another motor vehicle Damage to right rear

[^ Back To Top](#)



CARFAX HAS THE MOST ACCIDENT & DAMAGE INFORMATION

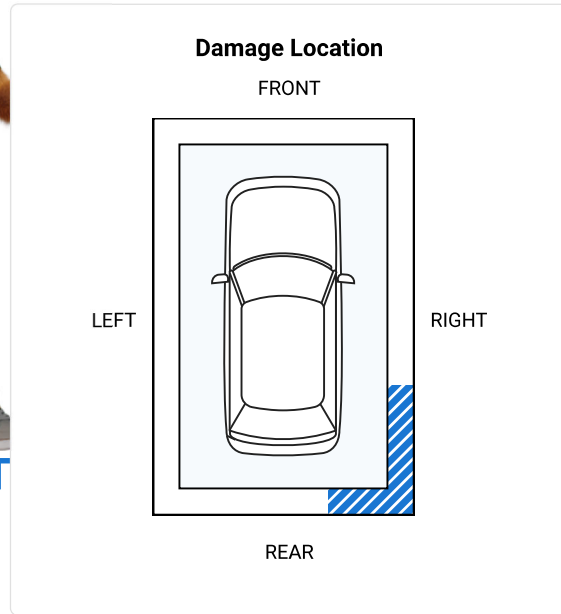
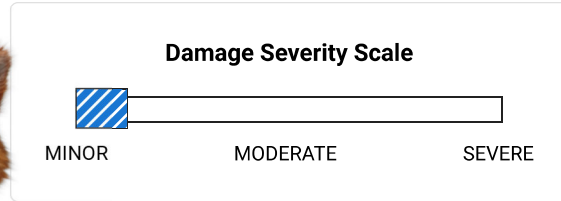

05/02/2012	Michigan Motor Vehicle Dept. Webberville, MI	Registration issued or renewed
05/01/2013	Michigan Motor Vehicle Dept. Webberville, MI	Registration issued or renewed
04/23/2014	Michigan Motor Vehicle Dept. Webberville, MI	Registration issued or renewed
04/24/2015	Michigan Motor Vehicle Dept. Webberville, MI	Registration issued or renewed
05/03/2016	Michigan Motor Vehicle Dept. Webberville, MI	Registration issued or renewed

[^ Back To Top](#)

05/06/2016 282,808 Champion Chevrolet of
Fowlerville
Fowlerville, MI
517-219-4082
championchevyfowlervill
e.com

★ 4.8 / 5.0

66 Verified Reviews

♥ 1,143 Customer
Favorites



Vehicle serviced

Oil and filter changed

10/20/2016 287,046 Auto Lab Of Howell
Howell, MI
517-545-7744

★ 5.0 / 5.0

52 Verified Reviews

♥ 28 Customer Favorites



Vehicle serviced

Steering/suspension checked
Two wheel alignment performed



Hmm, we haven't received any information on this car since October 2016. Before you buy, ask the seller for recent service or repair records.

Have Questions? Consumers, please visit our Help Center at www.carfax.com. Dealers or Subscribers, please visit our Help Center at www.carfaxonline.com.



Glossary

Accident Indicator

CARFAX receives information about accidents in all 50 states, the District of Columbia and Canada.

Not every accident is reported to CARFAX. As details about the accident become available, those additional details are added to the CARFAX Vehicle History Report. CARFAX recommends that you have this vehicle inspected by a qualified mechanic.

- According to the National Safety Council, Injury Facts, 2021 edition, 5% of the 276 million registered vehicles in the U.S. were involved in an accident in 2019. Over 77% of these were considered minor or moderate.
- This CARFAX Vehicle History Report is based only on information supplied to CARFAX and available as of 5/4/24 at 6:02:20 AM (CDT). Other information about this vehicle, including problems, may not have been reported to CARFAX. Use this report as one important tool, along with a vehicle inspection and test drive, to make a better decision about your next used car.

Damage Severity

Damage events result in one of the following severity levels:

- **Minor:** Generally, minor damage is cosmetic (including dents or scratches), may only require reconditioning, and typically does not compromise a vehicle's operation and/or safety.
- **Moderate:** Moderate damage may affect multiple components of the vehicle and may impair the vehicle's operation and/or safety.
- **Severe:** Severe damage usually affects multiple components of the vehicle and is likely to compromise the vehicle's operation and/or safety.

^ Back To Top

CARFAX recommends getting a pre-purchase inspection at a certified collision repair facility.

First Owner



When the first owner(s) obtains a title from a Department of Motor Vehicles as proof of ownership.

New Owner Reported

When a vehicle is sold to a new owner, the Title must be transferred to the new owner(s) at a Department of Motor Vehicles.

Ownership History

CARFAX defines an owner as an individual or business that possesses and uses a vehicle. Not all title transactions represent changes in ownership. To provide estimated number of owners, CARFAX proprietary technology analyzes all the events in a vehicle history. Estimated ownership is available for vehicles manufactured after 1991 and titled solely in the US including Puerto Rico. Dealers sometimes opt to take ownership of a vehicle and are required to in the following states: Maine, Massachusetts, New Jersey, Ohio, Oklahoma, Pennsylvania and South Dakota. Please consider this as you review a vehicle's estimated ownership history.

Follow Us:  facebook.com/CARFAX  [@CARFAXinc](https://twitter.com/CARFAXinc)  [About CARFAX](#)

CARFAX DEPENDS ON ITS SOURCES FOR THE ACCURACY AND RELIABILITY OF ITS INFORMATION. THEREFORE, NO RESPONSIBILITY IS ASSUMED BY CARFAX OR ITS AGENTS FOR ERRORS OR OMISSIONS IN THIS REPORT. CARFAX FURTHER EXPRESSLY DISCLAIMS ALL WARRANTIES, EXPRESS OR IMPLIED, INCLUDING ANY IMPLIED WARRANTIES OF MERCHANTABILITY OR FITNESS FOR A PARTICULAR PURPOSE.

© 2024 CARFAX, Inc., part of S&P Global. All rights reserved.
5/4/24 6:02:20 AM (CDT)

I have reviewed and received a copy of the CARFAX Vehicle History Report for this 1999 CHEVROLET SUBURBAN vehicle (VIN: 3GNFK16R6XG134010), which is based on information supplied to CARFAX and available as of 5/4/24 at 7:02 AM (EDT).

Customer Signature

Date

Dealer Signature

Date

[^ Back To Top](#)