



### History-Based Value Report

#### History events affecting this vehicle's value



Service History



Personal Vehicle



Damage

**\$6,790 Retail Value**



### Vehicle History Report™

US \$44.99

**2006 LAND ROVER  
RANGE ROVER SPORT  
SUPERCHARGED**

VIN: SALSH23456A907415  
4 DOOR WAGON/SPORT  
UTILITY  
4.2L V8 F  
GASOLINE  
ALL WHEEL DRIVE

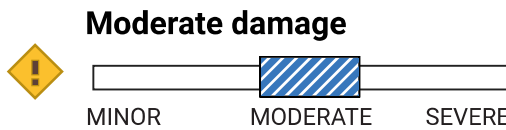

**34** Service history records

**4** Previous owners

Personal vehicle

**136,625** Last reported odometer reading

This CARFAX Vehicle History Report is based only on information supplied to CARFAX and available as of 1/31/24 at 10:45:33 AM (CST). Other information about this vehicle, including problems, may not have been reported to CARFAX. Use this report as one important tool, along with a vehicle inspection and test drive, to make a better decision about your next used car.

 <b>Ownership History</b> The number of owners is estimated	Owners 1-2	Owner 3	Owner 4
Year purchased	2005	2018	2018
Type of owner	Personal	Personal	Personal
Estimated length of ownership	13 years	4 months	4 yrs. 11 mo.
Owned in the following states/provinces	Illinois, Illinois	Missouri	Missouri
Estimated miles driven per year	See Details	---	---
Last reported odometer reading	89,429	94,539	136,625

 <b>Title History</b> CARFAX guarantees the information in this section	Owners 1-2	Owner 3	Owner 4
<b>Damage Brands</b> Salvage   Junk   Rebuilt   Fire   Flood   Hail   Lemon	<input checked="" type="checkbox"/> <b>Guaranteed</b> No Problem	<input checked="" type="checkbox"/> <b>Guaranteed</b> No Problem	<input checked="" type="checkbox"/> <b>Guaranteed</b> No Problem
<b>Odometer Brands</b> Not Actual Mileage   Exceeds Mechanical Limits	<input checked="" type="checkbox"/> <b>Guaranteed</b> No Problem	<input checked="" type="checkbox"/> <b>Guaranteed</b> No Problem	<input checked="" type="checkbox"/> <b>Guaranteed</b> No Problem



**GUARANTEED** - None of these title problems were reported by a U.S. state Department of Motor Vehicles (DMV). If you find that any of these title problems were reported by a DMV and not included in this report, you may qualify. [View Terms](#) | [View Certificate](#)

 <b>Additional History</b> Not all accidents / issues are reported to CARFAX	Owners 1-2	Owner 3	Owner 4
<b>Total Loss</b> No total loss reported to CARFAX.	<input checked="" type="checkbox"/> No Issues Reported	<input checked="" type="checkbox"/> No Issues Reported	<input checked="" type="checkbox"/> No Issues Reported
<b>Structural Damage</b> CARFAX recommends that you have this vehicle inspected by a collision repair specialist.	<input checked="" type="checkbox"/> No Issues Reported	<input checked="" type="checkbox"/> No Issues Reported	<input checked="" type="checkbox"/> No Issues Reported
<b>Airbag Deployment</b> No airbag deployment reported to CARFAX.	<input checked="" type="checkbox"/> No Issues Reported	<input checked="" type="checkbox"/> No Issues Reported	<input checked="" type="checkbox"/> No Issues Reported

<b>Odometer Check</b> No indication of an odometer rollback.	No Issues Indicated	No Issues Indicated	No Issues Indicated
<b>Accident / Damage</b> Damage reported: 04/18/2014, 09/23/2014, and 12/21/2023.	Damage Reported	No New Issues Reported	Damage Reported
<b>Manufacturer Recall</b> No open recalls reported to CARFAX. Check with an authorized Land Rover dealer for any open recalls.	No Recalls Reported	No Recalls Reported	No Recalls Reported
<b>Basic Warranty</b> Original warranty estimated to have expired.	<b>Warranty Expired</b>	<b>Warranty Expired</b>	<b>Warranty Expired</b>



**CARFAX** Detailed History







**Owner 1**  
 Purchased: 2005

Personal Vehicle

Date	Mileage	Source	Comments
07/15/2005		Illinois Motor Vehicle Dept. Chicago, IL	<b>Titled or registered as personal vehicle</b>
09/09/2005	15	Illinois Motor Vehicle Dept. Chicago, IL Title #X5252645578	<b>Title issued or updated</b> First owner reported
03/01/2006		Dealer Inventory	<b>Vehicle sold</b>
03/30/2006	5,726	Service Facility <b>4.4 / 5.0</b> 202 Verified Reviews <b>50</b> Customer Favorites	<b>Vehicle serviced</b> Tire condition and pressure checked Oil and filter changed Fluids checked
05/30/2006	7,077	Service Facility <b>4.4 / 5.0</b> 202 Verified Reviews <b>50</b> Customer Favorites	<b>Vehicle serviced</b> 7,500 mile service performed One tire mounted Brush/grille guard installed Console replaced

01/11/2007	13,203	<p>Service Facility</p> <p>★ 4.4 / 5.0</p> <p>202 Verified Reviews</p> <p>♥ 50 Customer Favorites</p>		<p><b>Vehicle serviced</b></p> <p>Maintenance inspection completed</p> <p>15,000 mile service performed</p> <p>Transfer module/computer reprogrammed</p> <p>Trim repaired</p> <p>Front brake pads replaced</p> <p>Battery replaced</p> <p>Rear brake pads replaced</p> <p>Battery/charging system checked</p>
06/18/2009		<p>Illinois</p> <p>Motor Vehicle Dept.</p> <p>Chicago, IL</p>		<p><b>Registration issued or renewed</b></p>
09/09/2009	33,486	<p>Howard Orloff Imports, Inc.</p> <p>Chicago, IL</p> <p>773-227-3200</p> <p>orloff.com</p> <p>★ 4.4 / 5.0</p> <p>202 Verified Reviews</p> <p>♥ 50 Customer Favorites</p>		<p><b>Vehicle serviced</b></p> <p>Maintenance inspection completed</p>
06/14/2010	34,000	<p>Illinois</p> <p>Inspection Station</p> <p>Chicago, IL</p>		<p><b>Passed emissions inspection</b></p>
06/29/2010		<p>Illinois</p> <p>Motor Vehicle Dept.</p> <p>Chicago, IL</p>		<p><b>Registration issued or renewed</b></p>
02/26/2011	36,098	<p>Howard Orloff Imports, Inc.</p> <p>Chicago, IL</p> <p>773-227-3200</p> <p>orloff.com</p> <p>★ 4.4 / 5.0</p> <p>202 Verified Reviews</p> <p>♥ 50 Customer Favorites</p>		<p><b>Vehicle serviced</b></p> <p>Maintenance inspection completed</p> <p>Battery/charging system checked</p> <p>No-start/hard start condition checked</p> <p>Brake fluid flushed/changed</p> <p>Starter replaced</p> <p>Battery cable(s) replaced</p> <p>Electrical system checked</p> <p>Fuel injection system flushed/serviced</p> <p>Power steering fluid flushed/changed</p>
07/12/2011		<p>Illinois</p> <p>Motor Vehicle Dept.</p> <p>Chicago, IL</p>		<p><b>Registration issued or renewed</b></p>

05/19/2012	40,406	Howard Orloff Imports, Inc. Chicago, IL 773-227-3200 orloff.com ★ 4.4 / 5.0 202 Verified Reviews ♥ 50 Customer Favorites		<b>Vehicle serviced</b> Maintenance inspection completed Power steering pump replaced Oil and filter changed Antifreeze/coolant flushed/changed Light bulb(s) replaced Battery/charging system checked
07/26/2012	41,000	Illinois Inspection Station Chicago, IL		<b>Passed emissions inspection</b>
07/31/2012		Illinois Motor Vehicle Dept. Chicago, IL		<b>Registration issued or renewed</b>
11/06/2012	43,350	Howard Orloff Imports, Inc. Chicago, IL 773-227-3200 orloff.com ★ 4.4 / 5.0 202 Verified Reviews ♥ 50 Customer Favorites		<b>Vehicle serviced</b>
03/01/2013	45,007	Howard Orloff Imports, Inc. Chicago, IL 773-227-3200 orloff.com ★ 4.4 / 5.0 202 Verified Reviews ♥ 50 Customer Favorites		<b>Vehicle serviced</b> Maintenance inspection completed
06/17/2013		Illinois Motor Vehicle Dept. Chicago, IL		<b>Registration issued or renewed</b>
11/29/2013	49,247	Howard Orloff Imports, Inc. Chicago, IL 773-227-3200 orloff.com ★ 4.4 / 5.0 202 Verified Reviews ♥ 50 Customer Favorites		<b>Vehicle serviced</b> Maintenance inspection completed Recommended maintenance performed Battery/charging system checked Brake fluid flushed/changed Tire repaired Air filter replaced

04/18/2014

Damage Report



**Damage reported: minor to moderate damage**

- Damage to right rear
- Damage to rear
- Damage to right front
- Damage to right side



**CARFAX HAS THE MOST ACCIDENT & DAMAGE INFORMATION**

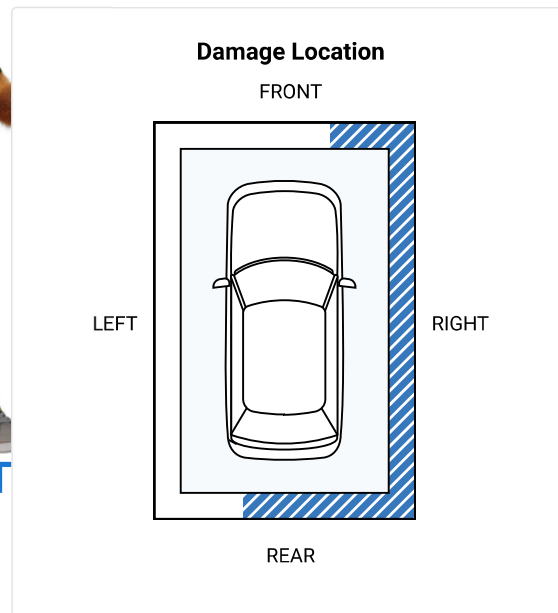
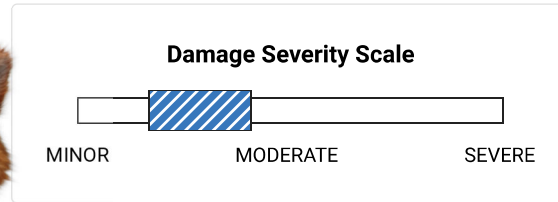

05/17/2014 52,557

Howard Orloff Imports, Inc.  
Chicago, IL  
773-227-3200  
orloff.com

★ **4.4 / 5.0**  
202 Verified Reviews  
♥ **50** Customer Favorites



**Vehicle serviced**

- Maintenance inspection completed
- 7,500 mile service performed
- Battery/charging system checked
- Cabin air filter replaced/cleaned
- Light bulb(s) replaced
- Sway bar link(s) replaced

08/06/2014 54,000

Illinois Inspection Station  
Chicago, IL

**Passed emissions inspection**

08/06/2014

Illinois Motor Vehicle Dept.  
Chicago, IL

**Registration issued or renewed**

- Correction to record
- Registration updated when owner moved the vehicle to a new location

09/22/2014 55,125

Howard Orloff Imports, Inc.  
Chicago, IL  
773-227-3200  
orloff.com

★ 4.4 / 5.0

202 Verified Reviews

♥ 50 Customer Favorites



**Vehicle serviced**

Maintenance inspection completed  
Battery/charging system checked  
Front brake pads replaced  
Rear brake pads replaced  
Rear brake rotor(s) replaced  
Vehicle washed/detailed

09/23/2014

Damage Report



**Damage reported: moderate damage**

Damage to left rear  
Damage to right rear  
Damage to rear  
Damage to left side  
Damage to right front  
Damage to right side  
Damage to roof



**CARFAX HAS THE MOST ACCIDENT & DAMAGE INFORMATION**

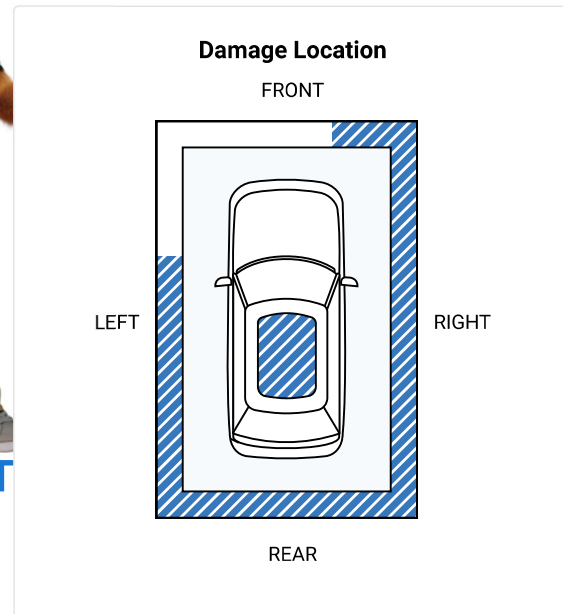
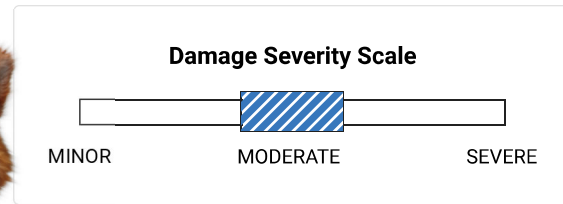

10/01/2014 55,295

Howard Orloff Imports, Inc.  
Chicago, IL  
773-227-3200  
orloff.com

★ 4.4 / 5.0





202 Verified Reviews

♥ 50 Customer Favorites





**Vehicle serviced**

Maintenance inspection completed  
Battery/charging system checked  
Brake fluid flushed/changed  
Fuel injection system flushed/serviced

01/12/2015	56,474	Waukegan Tire Certified Service Center Park City, IL 847-336-5305 ★ <b>4.8 / 5.0</b> 246 Verified Reviews ❤️ <b>131</b> Customer Favorites		<b>Vehicle serviced</b> Tire(s) balanced Tire(s) replaced Tire condition and pressure checked
01/21/2015	56,721	Waukegan Tire Certified Service Center Park City, IL 847-336-5305 ★ <b>4.8 / 5.0</b> 246 Verified Reviews ❤️ <b>131</b> Customer Favorites		<b>Vehicle serviced</b>
01/30/2015	56,759	Howard Orloff Imports, Inc. Chicago, IL 773-227-3200 orloff.com ★ <b>4.4 / 5.0</b> 202 Verified Reviews ❤️ <b>50</b> Customer Favorites		<b>Vehicle serviced</b> Oil and filter changed Maintenance reminder reset Four wheel alignment performed Alignment performed
04/20/2015	58,782	Howard Orloff Imports, Inc. Chicago, IL 773-227-3200 orloff.com ★ <b>4.4 / 5.0</b> 202 Verified Reviews ❤️ <b>50</b> Customer Favorites		<b>Vehicle serviced</b> Maintenance inspection completed
05/18/2015		Illinois Motor Vehicle Dept.		<b>Vehicle purchase reported</b>
05/26/2015	59,157	Dealer Inventory		<b>Vehicle offered for sale</b>
05/26/2015	59,178	Illinois Motor Vehicle Dept. Chicago, IL Title #151464070040		<b>Title issued or updated</b> Dealer took title of this vehicle while it was in inventory Loan or lien reported Vehicle color noted as Silver
05/29/2015	59,311	Dealer Inventory		<b>Vehicle offered for sale</b>



05/29/2015	59,316	Fields Chrysler Jeep Dodge Ram Glenview Glenview, IL 847-446-5100 fieldschryslerjeepdodge.com ★ 4.7 / 5.0 754 Verified Reviews ❤️ 1,414 Customer Favorites	 <b>Vehicle serviced</b> Pre-delivery inspection completed Hood prop rod replaced Tires rotated Oil and filter changed
05/30/2015		Fields Chrysler Jeep Dodge Ram Glenview Glenview, IL 847-446-5100 fieldschryslerjeepdodge.com ★ 4.7 / 5.0 754 Verified Reviews ❤️ 1,414 Customer Favorites	<b>Vehicle sold</b>
05/30/2015		Illinois Motor Vehicle Dept.	<b>Vehicle purchase reported</b>
06/17/2015		Illinois Motor Vehicle Dept. Forest Park, IL	<b>Registration issued or renewed</b> Correction to record



**Owner 2**  
Purchased: 2015





**Low mileage!** This owner drove less than the industry average of 15,000 miles per year.

Personal Vehicle  
8,255 mi/yr

Date	Mileage	Source	Comments
06/22/2015		Illinois Motor Vehicle Dept. Forest Park, IL Title #151736941820	<b>Title issued or updated</b> New owner reported Vehicle color noted as Silver
08/19/2016	73,122	Sears Auto Center Aurora, IL 630-820-6128 searsauto.com ★ 4.3 / 5.0 48 Verified Reviews	 <b>Vehicle serviced</b> Maintenance inspection completed Oil and filter changed
10/12/2016		Illinois Motor Vehicle Dept. Naperville, IL	<b>Registration issued or renewed</b> Correction to record





05/23/2017		Illinois Motor Vehicle Dept. Naperville, IL	<b>Registration issued or renewed</b>
08/05/2018		Missouri Motor Vehicle Dept.	<b>Vehicle purchase reported</b>
08/10/2018	89,429	Missouri Inspection Station Saint Charles, MO	<b>Passed emissions inspection</b>





 **Owner 3** Personal Vehicle  
Purchased: 2018





Date	Mileage	Source	Comments
08/14/2018		Missouri Motor Vehicle Dept. Saint Charles, MO Title #TZR37586	<b>Title issued or updated</b> Registration issued or renewed New owner reported Exempt from odometer reporting
11/14/2018	93,635	Plaza Land Rover Jaguar Saint Louis, MO 844-223-0651 plazalandrover.com/ ★ 4.5 / 5.0 89 Verified Reviews ❤️ 38 Customer Favorites	 <b>Vehicle serviced</b> Maintenance inspection completed Vehicle washed/detailed Oil and filter changed
11/20/2018	93,815	Missouri Inspection Station Saint Louis, MO	<b>Failed emissions inspection</b>
12/06/2018	94,539	Plaza Land Rover Jaguar Saint Louis, MO 844-223-0651 plazalandrover.com/ ★ 4.5 / 5.0 89 Verified Reviews ❤️ 38 Customer Favorites	 <b>Vehicle serviced</b> Maintenance inspection completed Four wheel alignment performed Vehicle washed/detailed Tire(s) balanced Tires rotated

 **Owner 4** Personal Vehicle  
Purchased: 2018

Date	Mileage	Source	Comments
12/31/2018		Missouri Motor Vehicle Dept.	<b>Vehicle purchase reported</b>

01/18/2019		Missouri Motor Vehicle Dept. Saint Louis, MO Title #TJT62562		<b>Title issued or updated</b> New owner reported Exempt from odometer reporting
05/14/2019	99,518	Plaza Land Rover Jaguar Saint Louis, MO 844-223-0651 plazalandrover.com/ ★ 4.5 / 5.0 89 Verified Reviews ❤️ 38 Customer Favorites		<b>Vehicle serviced</b> Maintenance inspection completed Four wheel alignment performed Vehicle washed/detailed
06/04/2019	100,525	Car-X Tire & Auto University City, MO 314-727-7270 carx.com ★ 4.5 / 5.0 110 Verified Reviews ❤️ 106 Customer Favorites		<b>Vehicle serviced</b> Safety inspection performed Emissions inspection performed Emissions or safety inspection performed
06/04/2019		Missouri Inspection Station Saint Louis, MO		<b>Passed emissions inspection</b>
06/12/2019		Missouri Motor Vehicle Dept. Saint Louis, MO Title #TJT62562		<b>Registration issued or renewed</b> Exempt from odometer reporting
08/01/2019	101,866	Plaza Land Rover Jaguar Saint Louis, MO 844-223-0651 plazalandrover.com/ ★ 4.5 / 5.0 89 Verified Reviews ❤️ 38 Customer Favorites		<b>Vehicle serviced</b> Maintenance inspection completed Vehicle washed/detailed Oil and filter changed
03/19/2020	111,123	Sam's Club Tire & Battery Center Saint Louis, MO 314-822-7200 https:// www.samsclub.com ★ 4.6 / 5.0 33 Verified Reviews		<b>Vehicle serviced</b> Tire repaired

11/13/2020		Plaza Land Rover Jaguar Saint Louis, MO 844-223-0651 plazalandrover.com/ ★ 4.5 / 5.0 89 Verified Reviews ♥ 38 Customer Favorites		<b>Vehicle serviced</b> Maintenance inspection completed Oil and filter changed Emissions inspection performed
11/13/2020	113,967	Missouri Inspection Station Saint Louis, MO		<b>Passed emissions inspection</b>
11/19/2020		Missouri Motor Vehicle Dept. Saint Louis, MO Title #TJT62562		<b>Registration issued or renewed</b> Exempt from odometer reporting Registration updated when owner moved the vehicle to a new location
11/28/2020		Plaza Land Rover Jaguar Saint Louis, MO 844-223-0651 plazalandrover.com/ ★ 4.5 / 5.0 89 Verified Reviews ♥ 38 Customer Favorites		<b>Vehicle serviced</b> Maintenance inspection completed Oil and filter changed Emissions inspection performed
05/07/2021	115,748	Plaza Land Rover Jaguar Saint Louis, MO 844-223-0651 plazalandrover.com/ ★ 4.5 / 5.0 89 Verified Reviews ♥ 38 Customer Favorites		<b>Vehicle serviced</b> Maintenance inspection completed Four wheel alignment performed Alternator replaced Starter replaced
10/21/2021	123,951	Meineke Car Care Center Brentwood, MO 314-961-4228 meineke.com ★ 4.7 / 5.0 22 Verified Reviews ♥ 40 Customer Favorites		<b>Vehicle serviced</b> Serpentine belt replaced Drive belt tensioner replaced Drive belt tensioner pulley replaced Power steering checked
11/30/2021	124,099	Meineke Car Care Center Brentwood, MO 314-961-4228 meineke.com ★ 4.7 / 5.0 22 Verified Reviews ♥ 40 Customer Favorites		<b>Vehicle serviced</b> Stabilizer bar replaced

12/31/2021	124,748	Rasch Service Center Saint Louis, MO 314-821-3377 raschservice.com/ ★ 4.9 / 5.0 169 Verified Reviews ❤️ 90 Customer Favorites		<b>Vehicle serviced</b> Brake fluid flushed/changed Heater hose(s) replaced
02/08/2022		Sam's Club Tire & Battery Center Saint Louis, MO 314-822-7200 https://www.samsclub.com ★ 4.6 / 5.0 33 Verified Reviews		<b>Vehicle serviced</b> Tire repaired Tire(s) replaced
04/26/2022	128,531	Plaza Land Rover Jaguar Saint Louis, MO 844-223-0651 plazalandrover.com/ ★ 4.5 / 5.0 89 Verified Reviews ❤️ 38 Customer Favorites		<b>Vehicle serviced</b> Maintenance inspection completed Oil and filter changed Emissions inspection performed
04/26/2022		Missouri Inspection Station		<b>Passed emissions inspection</b>
04/29/2022		Missouri Motor Vehicle Dept. Saint Louis, MO Title #TJT62562		<b>Registration issued or renewed</b> Exempt from odometer reporting
06/21/2022	130,749	Plaza Land Rover Jaguar Saint Louis, MO 844-223-0651 plazalandrover.com/ ★ 4.5 / 5.0 89 Verified Reviews ❤️ 38 Customer Favorites		<b>Vehicle serviced</b> Maintenance inspection completed
12/05/2022	136,625	Plaza Land Rover Jaguar Saint Louis, MO 844-223-0651 plazalandrover.com/ ★ 4.5 / 5.0 89 Verified Reviews ❤️ 38 Customer Favorites		<b>Vehicle serviced</b> Maintenance inspection completed Cooling system checked Oil and filter changed Brakes checked

12/21/2023

Damage Report

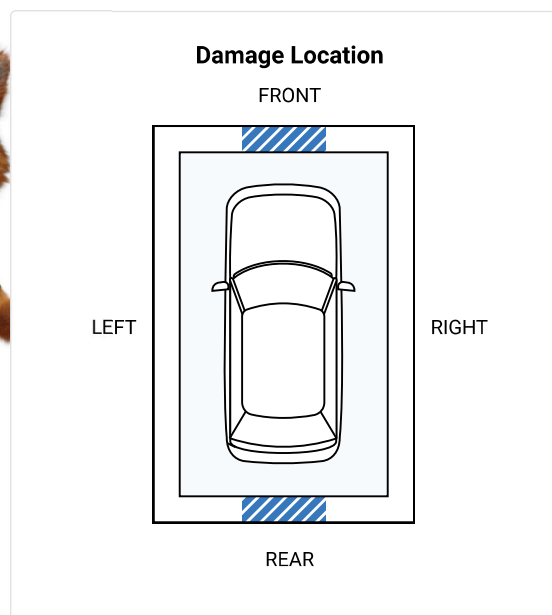
**Damage reported**Damage to front  
Damage to rear**CARFAX HAS THE MOST  
ACCIDENT & DAMAGE  
INFORMATION**Not all damage is caused by an accident. Get  
the car inspected before you buy. [Learn More](#)Have Questions? Consumers, please visit our Help Center at [www.carfax.com](http://www.carfax.com). Dealers or  
Subscribers, please visit our Help Center at [www.carfaxonline.com](http://www.carfaxonline.com).**Glossary****Damage Indicator**

Damage can be a result of many different types of events. Examples include contact with objects (other cars, trees, traffic signs, road debris, etc), vandalism, or weather-related events. Not every damage event is reported to CARFAX. As details about the damage event become available, those additional details are added to the CARFAX Vehicle History Report. CARFAX recommends that you have this vehicle inspected by a qualified mechanic.

- This CARFAX Vehicle History Report is based only on information supplied to CARFAX and available as of 1/31/24 at 10:45:33 AM (CST). Other information about this vehicle, including problems, may not have been reported to CARFAX. Use this report as one important tool, along with a vehicle inspection and test drive, to make a better decision about your next used car.

**Damage Severity**

Damage events result in one of the following severity levels:

- **Minor:** Generally, minor damage is cosmetic (including dents or scratches), may only require reconditioning, and typically does not compromise a vehicle's operation and/or safety.

- Moderate: Moderate damage may affect multiple components of the vehicle and may impair the vehicle's operation and/or safety.
- Severe: Severe damage usually affects multiple components of the vehicle and is likely to compromise the vehicle's operation and/or safety.

CARFAX recommends getting a pre-purchase inspection at a certified collision repair facility.

#### Failed Emissions Inspection

The emissions check performed during a vehicle inspection indicated the vehicle was emitting more than allowable emissions standards and/or had missing or modified parts. Repeated failed emissions records can indicate engine problems and CARFAX recommends you have the vehicle inspected.

#### First Owner

When the first owner(s) obtains a title from a Department of Motor Vehicles as proof of ownership.

#### New Owner Reported

When a vehicle is sold to a new owner, the Title must be transferred to the new owner(s) at a Department of Motor Vehicles.

#### Ownership History

CARFAX defines an owner as an individual or business that possesses and uses a vehicle. Not all title transactions represent changes in ownership. To provide estimated number of owners, CARFAX proprietary technology analyzes all the events in a vehicle history. Estimated ownership is available for vehicles manufactured after 1991 and titled solely in the US including Puerto Rico. Dealers sometimes opt to take ownership of a vehicle and are required to in the following states: Maine, Massachusetts, New Jersey, Ohio, Oklahoma, Pennsylvania and South Dakota. Please consider this as you review a vehicle's estimated ownership history.

#### Title Issued

A state issues a title to provide a vehicle owner with proof of ownership. Each title has a unique number. Each title or registration record on a CARFAX report does not necessarily indicate a change in ownership. In Canada, a registration and bill of sale are used as proof of ownership.

Follow Us:



[facebook.com/CARFAX](https://www.facebook.com/CARFAX)



[@CARFAXinc](https://twitter.com/CARFAXinc)



[About CARFAX](#)

CARFAX DEPENDS ON ITS SOURCES FOR THE ACCURACY AND RELIABILITY OF ITS INFORMATION. THEREFORE, NO RESPONSIBILITY IS ASSUMED BY CARFAX OR ITS AGENTS FOR ERRORS OR OMISSIONS IN THIS REPORT. CARFAX FURTHER EXPRESSLY DISCLAIMS ALL WARRANTIES, EXPRESS OR IMPLIED, INCLUDING ANY IMPLIED WARRANTIES OF MERCHANTABILITY OR FITNESS FOR A PARTICULAR PURPOSE.

© 2024 CARFAX, Inc., part of S&P Global. All rights reserved.

1/31/24 10:45:33 AM (CST)

**I have reviewed and received a copy of the CARFAX Vehicle History Report for this 2006 LAND ROVER RANGE ROVER SPORT vehicle (VIN: SALSH23456A907415), which is based on information supplied to CARFAX and available as of 1/31/24 at 11:45 AM (EST).**

Customer Signature

Date

Dealer Signature

Date