

Display CARFAX in online listings:



This report provided free of charge by:

Nova International LLC

1919 E Kilgore Service Rd Ste 201
Kalamazoo, MI 49001

(269) 317-4803



History-Based Value Report

\$5,650

CARFAX Retail Value

History events affecting this vehicle's value

- 1-Owner Vehicle
- Service History
- Personal Vehicle
- Minor Damage



Vehicle History Report™

US \$44.99

2008 MITSUBISHI ECLIPSE GS

VIN: 4A3AK24FX8E005100
HATCHBACK 2 DR
2.4L I4 F SOHC 16V
GASOLINE
FRONT WHEEL DRIVE
Original Window Sticker

This CARFAX Report Provided
by:
Nova International LLC

Accident reported: minor damage

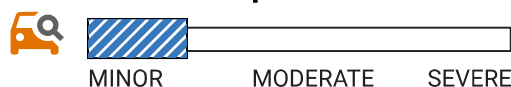

37 Service history records

1 CARFAX 1-Owner vehicle

Personal vehicle

165,971 Last reported odometer reading



This CARFAX Vehicle History Report is based only on information supplied to CARFAX and available as of 11/8/24 at 2:54:58 PM (CST). Other information about this vehicle, including problems, may not have been reported to CARFAX. Use this report as one important tool, along with a vehicle inspection and test drive, to make a better decision about your next used car.



Accident / Damage History

Not all accidents / issues are reported to CARFAX

Event 1

04/23/2012

Accident reported: minor damage

Vehicle involved in rear end collision with another motor vehicle

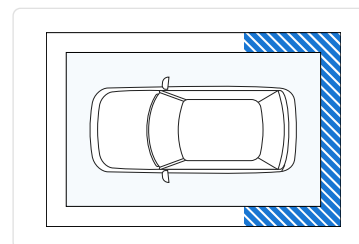
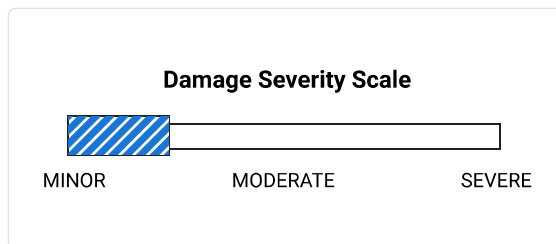

Event 2

05/11/2015

Damage reported: minor damage

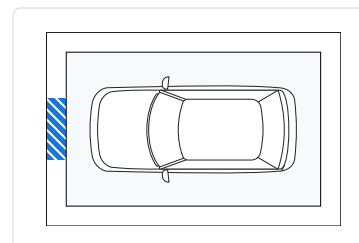
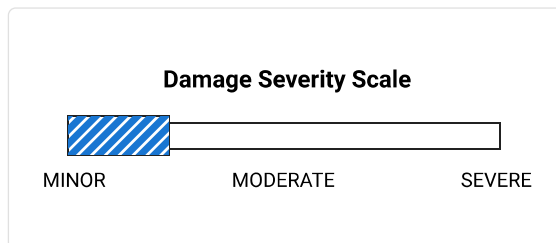

Additional History

Not all accidents / issues are reported to CARFAX

Owner 1

Total Loss

No total loss reported to CARFAX.

✓ No Issues Reported

Structural Damage

CARFAX recommends that you have this vehicle inspected by a collision repair specialist.

✓ No Issues Reported

Airbag Deployment

No airbag deployment reported to CARFAX.

✓ No Issues Reported

Odometer Check

No indication of an odometer rollback.

✓ No Issues Indicated

Accident / Damage

Accident reported: 04/23/2012. Damage reported: 05/11/2015.



Minor Damage





<p>Manufacturer Recall No open recalls reported to CARFAX.</p>	<p><input checked="" type="checkbox"/> No Recalls Reported</p>
<p>Basic Warranty Original warranty estimated to have expired.</p>	<p>Warranty Expired</p>







<p>CARFAX Title History CARFAX guarantees the information in this section</p>	<p>Owner 1</p>
<p>Damage Brands Salvage Junk Rebuilt Fire Flood Hail Lemon</p>	<p><input checked="" type="checkbox"/> Guaranteed No Problem</p>
<p>Odometer Brands Not Actual Mileage Exceeds Mechanical Limits</p>	<p><input checked="" type="checkbox"/> Guaranteed No Problem</p>
<p> GUARANTEED - None of these title problems were reported by a U.S. state Department of Motor Vehicles (DMV). If you find that any of these title problems were reported by a DMV and not included in this report, you may qualify. View Terms View Certificate</p>	



<p>CARFAX Ownership History The number of owners is estimated</p>	<p>Owner 1</p>
Year purchased	2008
Type of owner	Personal
Estimated length of ownership	16 yrs. 7 mo.
Owned in the following states/provinces	Kansas
Estimated miles driven per year	10,647/yr
Last reported odometer reading	165,971



<p>CARFAX Detailed History</p>			
<p> Owner 1 Purchased: 2008</p>		<p>Low mileage! This owner drove less than the industry average of 15,000 miles per year.</p>	<p>Personal Vehicle 10,647 mi/yr</p>
Date	Mileage	Source	Comments
05/16/2007		Mitsubishi Motors mitsubishicars.com	<p>Vehicle manufactured Liquid silver exterior Dark charcoal sport fabric interior</p> <p>Original Window Sticker</p>

05/28/2007	Mitsubishi Motors mitsubishicars.com		Vehicle shipped to original dealer in Overland Park, KS
06/06/2007 3	Reed Chrysler Dodge Jeep Ram Merriam, KS 913-381-8100 reedjeepchryslerdodgera m.com ★ 4.5 / 5.0 491 Verified Reviews ❤️ 7,643 Customer Favorites		Vehicle serviced
03/31/2008 18	Kansas Motor Vehicle Dept.		Vehicle purchase reported Titled or registered as personal vehicle
04/25/2008	Kansas Motor Vehicle Dept. Olathe, KS		Title or registration issued First owner reported
05/28/2008	Kansas Motor Vehicle Dept. Olathe, KS		Title or registration issued Loan or lien reported
07/07/2008	Kansas Motor Vehicle Dept. Olathe, KS		Registration issued or renewed
10/24/2008	Olathe Subaru Olathe, KS 913-780-0400 olathesubaru.com/ ★ 4.8 / 5.0 84 Verified Reviews		Vehicle serviced Recommended maintenance performed Electrical system checked
02/27/2009	Olathe Subaru Olathe, KS 913-780-0400 olathesubaru.com/ ★ 4.8 / 5.0 84 Verified Reviews		Vehicle serviced Recommended maintenance performed
06/19/2009	Olathe Subaru Olathe, KS 913-780-0400 olathesubaru.com/ ★ 4.8 / 5.0 84 Verified Reviews		Vehicle serviced Recommended maintenance performed Tire condition and pressure checked

10/02/2009	Olathe Subaru Olathe, KS 913-780-0400 olathesubaru.com/ ★ 4.8 / 5.0 84 Verified Reviews	 Vehicle serviced Recommended maintenance performed
10/16/2009	Olathe Subaru Olathe, KS 913-780-0400 olathesubaru.com/ ★ 4.8 / 5.0 84 Verified Reviews	 Vehicle serviced
02/10/2010 25,760	Mitsubishi Motors mitsubishicars.com	 Vehicle serviced Oil and filter changed
02/12/2010	Olathe Subaru Olathe, KS 913-780-0400 olathesubaru.com/ ★ 4.8 / 5.0 84 Verified Reviews	 Vehicle serviced Recommended maintenance performed Tire condition and pressure checked
07/30/2010	Olathe Subaru Olathe, KS 913-780-0400 olathesubaru.com/ ★ 4.8 / 5.0 84 Verified Reviews	 Vehicle serviced Recommended maintenance performed
05/28/2011	Olathe Subaru Olathe, KS 913-780-0400 olathesubaru.com/ ★ 4.8 / 5.0 84 Verified Reviews	 Vehicle serviced Recommended maintenance performed
06/21/2011	Kansas Motor Vehicle Dept. Olathe, KS	Registration issued or renewed
07/11/2011	Olathe Subaru Olathe, KS 913-780-0400 olathesubaru.com/ ★ 4.8 / 5.0 84 Verified Reviews	 Vehicle serviced

12/08/2011	Olathe Subaru Olathe, KS 913-780-0400 olathe.subaru.com/ ★ 4.8 / 5.0 84 Verified Reviews	 Vehicle serviced Recommended maintenance performed
12/27/2011	Olathe Subaru Olathe, KS 913-780-0400 olathe.subaru.com/ ★ 4.8 / 5.0 84 Verified Reviews	 Vehicle serviced A/C and heating system checked

04/23/2012 47,466 Damage Report





 **Accident reported: minor damage**
 Vehicle involved in rear end collision with another motor vehicle
 Damage to rear
 Damage to left rear
 Damage to right rear

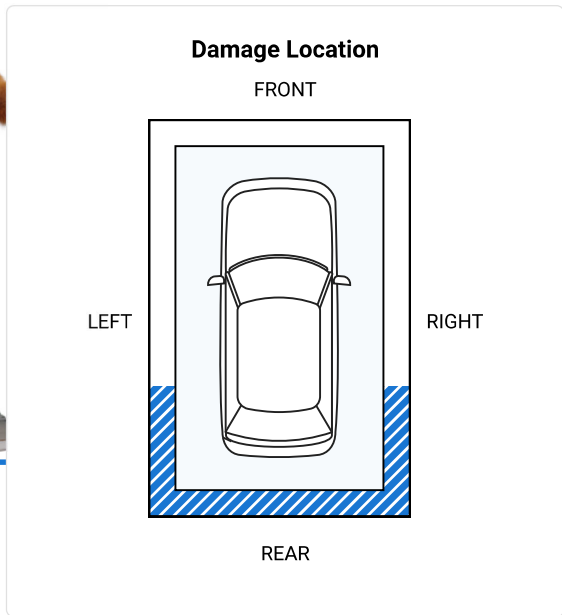
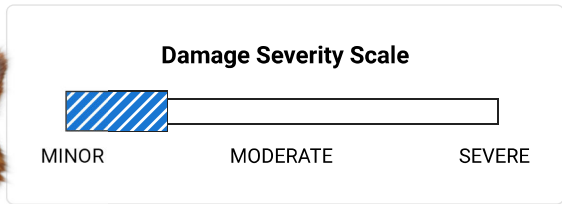

CARFAX HAS THE MOST ACCIDENT & DAMAGE INFORMATION



Minor damage is usually cosmetic, including dents or scratches to the vehicle body.

06/26/2012		Kansas Motor Vehicle Dept. Olathe, KS Title #Z1819975		Registration issued or renewed Loan or lien reported
06/14/2013	56,413	Olathe Subaru Olathe, KS 913-780-0400 olathesubaru.com/ ★ 4.8 / 5.0 84 Verified Reviews		Vehicle serviced Engine checked
06/19/2013		Kansas Motor Vehicle Dept. Olathe, KS Title #Z1819975		Registration issued or renewed Loan or lien reported
07/08/2013	56,661	Olathe Subaru Olathe, KS 913-780-0400 olathesubaru.com/ ★ 4.8 / 5.0 84 Verified Reviews		Vehicle serviced Recommended maintenance performed Engine checked
11/25/2013	60,498	Bailey's Auto Service Inc. Olathe, KS 913-764-0740 baileyautoservice.com/ ★ 4.9 / 5.0 32 Verified Reviews ❤️ 8 Customer Favorites		Vehicle serviced Front brake pads replaced
06/03/2014		Kansas Motor Vehicle Dept. Olathe, KS Title #Z1819975		Registration issued or renewed Loan or lien reported
06/19/2014	66,039	Olathe Subaru Olathe, KS 913-780-0400 olathesubaru.com/ ★ 4.8 / 5.0 84 Verified Reviews		Vehicle serviced Recommended maintenance performed
03/27/2015	74,033	Olathe Subaru Olathe, KS 913-780-0400 olathesubaru.com/ ★ 4.8 / 5.0 84 Verified Reviews		Vehicle serviced Recommended maintenance performed Engine checked Tire condition and pressure checked

05/11/2015

Damage Report



Damage reported: minor damage
Damage to front



CARFAX HAS THE MOST ACCIDENT & DAMAGE INFORMATION

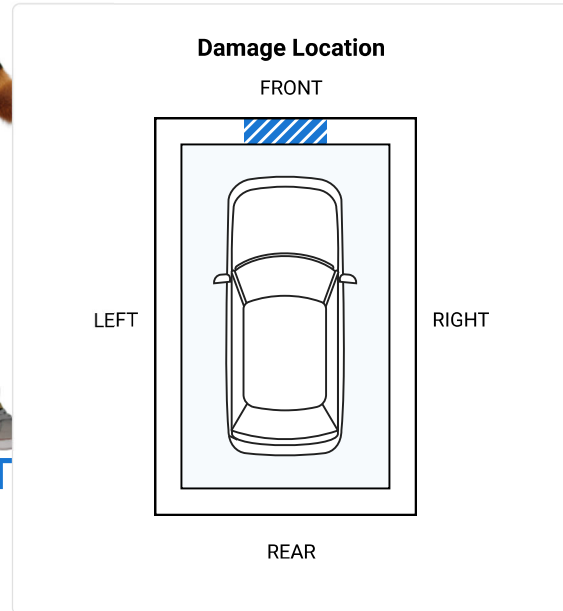
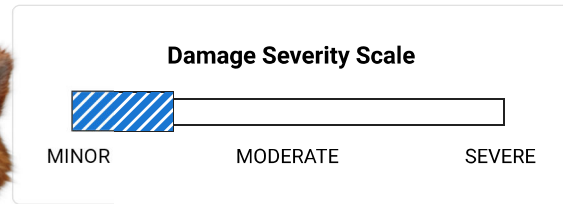

Minor damage is usually cosmetic, including dents or scratches to the vehicle body.

06/18/2015

Kansas
Motor Vehicle Dept.
Olathe, KS
Title #Z1819975

Registration issued or renewed
Loan or lien reported

05/20/2016 86,497

Olathe Subaru
Olathe, KS
913-780-0400
olathesubaru.com/







Vehicle serviced
Recommended maintenance performed
Engine checked





★ **4.8 / 5.0**
84 Verified Reviews





06/17/2016





Kansas
Motor Vehicle Dept.
Olathe, KS
Title #Z1819975



Registration issued or renewed
Loan or lien reported

06/15/2017		Kansas Motor Vehicle Dept. Olathe, KS Title #Z1819975		Registration issued or renewed Loan or lien reported
07/19/2017	100,602	Olathe Subaru Olathe, KS 913-780-0400 olathesubaru.com/ ★ 4.8 / 5.0 84 Verified Reviews		Vehicle serviced Recommended maintenance performed
05/22/2018		Kansas Motor Vehicle Dept. Olathe, KS Title #Z1819975		Registration issued or renewed Loan or lien reported
06/04/2018	106,970	Burnett Automotive Overland Park, KS 913-402-9007 burnettauto.com/ locations_overlandpark.html ★ 4.8 / 5.0 120 Verified Reviews ❤️ 2 Customer Favorites		Vehicle serviced Oil and filter changed
06/25/2018		Kansas Motor Vehicle Dept. Olathe, KS Title #Z1819975		Registration issued or renewed Loan or lien reported
12/01/2018	115,913	Burnett Automotive Overland Park, KS 913-402-9007 burnettauto.com/ locations_overlandpark.html ★ 4.8 / 5.0 120 Verified Reviews ❤️ 2 Customer Favorites		Vehicle serviced Oil and filter changed
02/02/2019	118,106	Burnett Automotive Overland Park, KS 913-402-9007 burnettauto.com/ locations_overlandpark.html ★ 4.8 / 5.0 120 Verified Reviews ❤️ 2 Customer Favorites		Vehicle serviced Battery/charging system checked Battery replaced

06/08/2019	122,799	Burnett Automotive Overland Park, KS 913-402-9007 burnettauto.com/ locations_overlandpark. html ★ 4.8 / 5.0 120 Verified Reviews ♥ 2 Customer Favorites	 Vehicle serviced Oil and filter changed
06/18/2019		Kansas Motor Vehicle Dept. Olathe, KS Title #Z1819975	Registration issued or renewed Loan or lien reported
11/15/2019	128,425	Burnett Automotive Overland Park, KS 913-402-9007 burnettauto.com/ locations_overlandpark. html ★ 4.8 / 5.0 120 Verified Reviews ♥ 2 Customer Favorites	 Vehicle serviced Oil and filter changed Tire(s) replaced Tires rotated Tire(s) mounted Tire condition and pressure checked
01/18/2020	130,257	Burnett Automotive Overland Park, KS 913-402-9007 burnettauto.com/ locations_overlandpark. html ★ 4.8 / 5.0 120 Verified Reviews ♥ 2 Customer Favorites	 Vehicle serviced Brake fluid flushed/changed Brakes checked
04/18/2020	133,211	Burnett Automotive Overland Park, KS 913-402-9007 burnettauto.com/ locations_overlandpark. html ★ 4.8 / 5.0 120 Verified Reviews ♥ 2 Customer Favorites	 Vehicle serviced Oil and filter changed
06/15/2020		Kansas Motor Vehicle Dept. Olathe, KS Title #Z1819975	Registration issued or renewed Loan or lien reported

09/17/2020	137,380	Sam's Club Tire & Battery Center Lenexa, KS 913-894-0084 https://www.samsclub.com ★ 4.7 / 5.0 44 Verified Reviews ♥ 1 Customer Favorite		Vehicle serviced Tire(s) replaced
10/29/2020	138,325	Burnett Automotive Overland Park, KS 913-402-9007 burnettauto.com/ locations_overlandpark.html ★ 4.8 / 5.0 120 Verified Reviews ♥ 2 Customer Favorites		Vehicle serviced Tire repaired One tire balanced Oil and filter changed Tire(s) replaced Tires rotated Tire(s) mounted
03/13/2021	140,565	Burnett Automotive Overland Park, KS 913-402-9007 burnettauto.com/ locations_overlandpark.html ★ 4.8 / 5.0 120 Verified Reviews ♥ 2 Customer Favorites		Vehicle serviced Oil and filter changed
05/20/2021		Kansas Motor Vehicle Dept. Olathe, KS Title #Z1819975		Registration issued or renewed Loan or lien reported
11/23/2021	146,915	Burnett Automotive Overland Park, KS 913-402-9007 burnettauto.com/ locations_overlandpark.html ★ 4.8 / 5.0 120 Verified Reviews ♥ 2 Customer Favorites		Vehicle serviced Oil and filter changed
06/16/2022		Kansas Motor Vehicle Dept. Olathe, KS Title #Z1819975		Registration issued or renewed Loan or lien reported

06/24/2022	Kansas Motor Vehicle Dept. Olathe, KS Title #AB2327859	Title issued or updated Loan or lien released
09/14/2022 152,889	Burnett Automotive Overland Park, KS 913-681-8824 burnettauto.com ★ 4.9 / 5.0 87 Verified Reviews ❤️ 2 Customer Favorites	 Vehicle serviced Oil and filter changed
11/21/2022 154,110	Meineke Car Care Center Overland Park, KS 913-871-9764 meineke.com ★ 4.0 / 5.0 67 Verified Reviews ❤️ 1,759 Customer Favorites	 Vehicle serviced Battery replaced
01/02/2023 154,937	Burnett Automotive Overland Park, KS 913-402-9007 burnettauto.com/ locations_overlandpark. html ★ 4.8 / 5.0 120 Verified Reviews ❤️ 2 Customer Favorites	 Vehicle serviced Tire(s) replaced Tire pressure monitoring system serviced
03/22/2023 156,157	Burnett Automotive Overland Park, KS 913-402-9007 burnettauto.com/ locations_overlandpark. html ★ 4.8 / 5.0 120 Verified Reviews ❤️ 2 Customer Favorites	 Vehicle serviced Oil and filter changed Tires rotated

04/11/2023	156,658	Burnett Automotive Overland Park, KS 913-402-9007 burnettauto.com/ locations_overlandpark. html ★ 4.8 / 5.0 120 Verified Reviews ♥ 2 Customer Favorites		Vehicle serviced Battery serviced Battery replaced Battery/charging system checked
06/12/2023		Kansas Motor Vehicle Dept. Olathe, KS Title #AB2327859		Registration issued or renewed
10/28/2023	165,971	Burnett Automotive Overland Park, KS 913-402-9007 burnettauto.com/ locations_overlandpark. html ★ 4.8 / 5.0 120 Verified Reviews ♥ 2 Customer Favorites		Vehicle serviced Oil and filter changed Tires rotated
06/13/2024		Kansas Motor Vehicle Dept. Olathe, KS Title #AB2327859		Registration issued or renewed
10/10/2024		Kansas Motor Vehicle Dept. Olathe, KS Title #AB4751846		Title issued or updated

Have Questions? Consumers, please visit our Help Center at www.carfax.com. Dealers or Subscribers, please visit our Help Center at www.carfaxonline.com.



Glossary

Accident Indicator

CARFAX receives information about accidents in all 50 states, the District of Columbia and Canada.

Not every accident is reported to CARFAX. As details about the accident become available, those additional details are added to the CARFAX Vehicle History Report. CARFAX recommends that you have this vehicle inspected by a qualified mechanic.

- According to the National Safety Council, Injury Facts, 2021 edition, 5% of the 276 million registered vehicles in the U.S. were involved in an accident in 2019. Over 77% of these were considered minor or moderate.
- This CARFAX Vehicle History Report is based only on information supplied to CARFAX and available

as of 11/8/24 at 2:54:58 PM (CST). Other information about this vehicle, including problems, may not have been reported to CARFAX. Use this report as one important tool, along with a vehicle inspection and test drive, to make a better decision about your next used car.

Damage Indicator

Damage can be a result of many different types of events. Examples include contact with objects (other cars, trees, traffic signs, road debris, etc), vandalism, or weather-related events. Not every damage event is reported to CARFAX. As details about the damage event become available, those additional details are added to the CARFAX Vehicle History Report. CARFAX recommends that you have this vehicle inspected by a qualified mechanic.

- This CARFAX Vehicle History Report is based only on information supplied to CARFAX and available as of 11/8/24 at 2:54:58 PM (CST). Other information about this vehicle, including problems, may not have been reported to CARFAX. Use this report as one important tool, along with a vehicle inspection and test drive, to make a better decision about your next used car.

Damage Severity

Damage events result in one of the following severity levels:

- **Minor:** Generally, minor damage is cosmetic (including dents or scratches), may only require reconditioning, and typically does not compromise a vehicle's operation and/or safety.
- **Moderate:** Moderate damage may affect multiple components of the vehicle and may impair the vehicle's operation and/or safety.
- **Severe:** Severe damage usually affects multiple components of the vehicle and is likely to compromise the vehicle's operation and/or safety.

CARFAX recommends getting a pre-purchase inspection at a certified collision repair facility.

First Owner

When the first owner(s) obtains a title from a Department of Motor Vehicles as proof of ownership.

Ownership History

CARFAX defines an owner as an individual or business that possesses and uses a vehicle. Not all title transactions represent changes in ownership. To provide estimated number of owners, CARFAX proprietary technology analyzes all the events in a vehicle history. Estimated ownership is available for vehicles manufactured after 1991 and titled solely in the US including Puerto Rico. Dealers sometimes opt to take ownership of a vehicle and are required to in the following states: Maine, Massachusetts, New Jersey, Ohio, Oklahoma, Pennsylvania and South Dakota. Please consider this as you review a vehicle's estimated ownership history.

Title Issued

A state issues a title to provide a vehicle owner with proof of ownership. Each title has a unique number. Each title or registration record on a CARFAX report does not necessarily indicate a change in ownership. In Canada, a registration and bill of sale are used as proof of ownership.

Follow Us:



[facebook.com/CARFAX](https://www.facebook.com/CARFAX)



[@CARFAXinc](https://twitter.com/CARFAXinc)



[About CARFAX](#)

CARFAX DEPENDS ON ITS SOURCES FOR THE ACCURACY AND RELIABILITY OF ITS INFORMATION. THEREFORE, NO RESPONSIBILITY IS ASSUMED BY CARFAX OR ITS AGENTS FOR ERRORS OR OMISSIONS IN THIS REPORT. CARFAX FURTHER EXPRESSLY DISCLAIMS ALL WARRANTIES, EXPRESS OR IMPLIED, INCLUDING ANY IMPLIED WARRANTIES OF MERCHANTABILITY OR FITNESS FOR A PARTICULAR PURPOSE.

© 2024 CARFAX, Inc., part of S&P Global. All rights reserved.
11/8/24 2:54:58 PM (CST)

I have reviewed and received a copy of the CARFAX Vehicle History Report for this 2008 MITSUBISHI ECLIPSE vehicle (VIN: 4A3AK24FX8E005100), which is based on information supplied to CARFAX and available as of 11/8/24 at 3:54 PM (EST).

Customer Signature	Date	Dealer Signature	Date
--------------------	------	------------------	------