



Report

US \$44.99

2015 Ford Taurus Police Interceptor

79,450 mi | VIN: 1FAHP2MT5FG121255 |

Sedan 4 DR | 3.5L V6 F DOHC 24V | Gasoline | All wheel drive

CARFAX HAS THE MOST ACCIDENT & DAMAGE INFORMATION

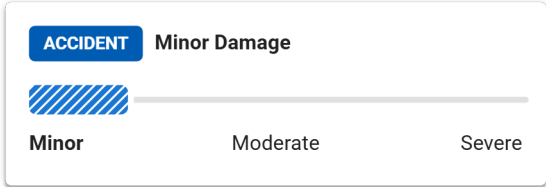

CARFAX VALUE \$4,040

5 Service history records

CARFAX 1-Owner vehicle

Last owned in Michigan

12 Detailed records available

This CARFAX Vehicle History Report is based only on information supplied to CARFAX and available as of 4/6/26 at 3:03:39 PM (CDT). Other information about this vehicle, including problems, may not have been reported to CARFAX. Use this report as one important tool, along with a vehicle inspection and test drive, to make a better decision about your next used car.



Accident / Damage History

Not all accidents / issues are reported to CARFAX

Event 1

04/26/2015

Accident reported: minor damage

- It hit an animal

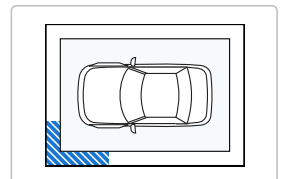
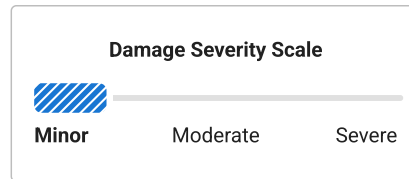

Event 2

03/09/2017

Accident reported: minor damage

- Airbags did not deploy

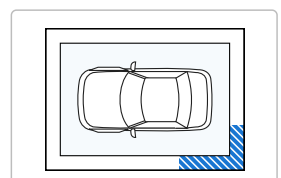
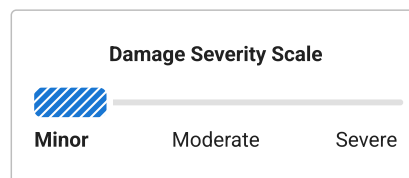

Event 3

07/12/2017

Accident reported: minor damage with another motor vehicle

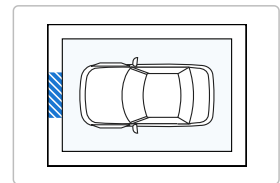
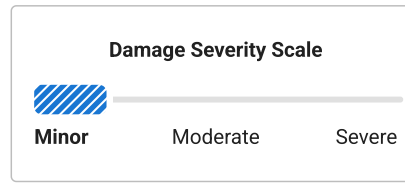

Event 4

08/06/2019

Accident reported: minor damage with another motor vehicle

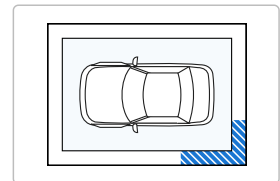
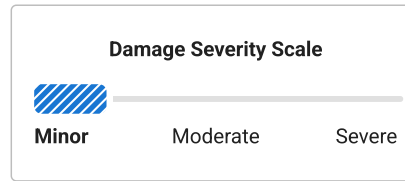

CARFAX History-Based Value Report

\$4,040

CARFAX Retail Value

History events affecting this vehicle's value

- 1-Owner Vehicle
- Minor Damage

CARFAX Additional History

Not all accidents / issues are reported to CARFAX

Owner 1

Total Loss

No total loss reported to CARFAX.

No Issues Reported

Structural Damage

CARFAX recommends that you have this vehicle inspected by a collision repair specialist.

No Issues Reported

Airbag Deployment

No airbag deployment reported to CARFAX.

No Issues Reported

Odometer Check

No indication of an odometer rollback.

No Issues Indicated

Accident / Damage

Accidents reported: 04/26/2015, 03/09/2017, 07/12/2017, and 08/06/2019.

Minor Damage

Manufacturer Recall

No open recalls reported to CARFAX. A current list of recalls is available at Ford Motor Company.

No Recalls Reported

Basic Warranty

Original warranty estimated to have expired.

Warranty Expired

CARFAX Title History

CARFAX guarantees the information in this section

Owner 1

Damage Brands

Salvage | Junk | Rebuilt | Fire | Flood | Hail | Lemon

Guaranteed
No Problem

Odometer Brands



Not Actual Mileage | Exceeds Mechanical Limits

Guaranteed
No Problem

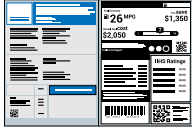

GUARANTEED - None of these title problems were reported by a U.S. state Department of Motor Vehicles (DMV). If you find that any of these title problems were reported by a DMV and not included in this report, you may qualify.
View Terms | View Certificate

CARFAX Ownership History		Owner 1
The number of owners is estimated		
Year purchased		2014
Type of owner		---
Estimated length of ownership		11 yrs. 5 mo.
Owned in the following states/provinces		Michigan
Estimated miles driven per year		37,130/yr
Last reported odometer reading		79,450

CARFAX Detailed History			
 Owner 1 Purchased: 2014			37,130 mi/yr
Date	Mileage	Source	Comments
09/25/2014		Ford Motor Company	Vehicle manufactured and shipped to original dealer Original Window Sticker 
09/26/2014	6	Signature Ford of Perry Perry, MI 800-364-2868 sigautogroup.com ★ 5.0 / 5.0 27 Verified Reviews	 Vehicle serviced - Pre-delivery inspection completed - Maintenance inspection completed - Battery/charging system checked - Brakes checked - Tire condition and pressure checked
09/30/2014	10	Signature Ford Lincoln Owosso, MI 800-364-2868 sigautogroup.com	Vehicle offered for sale
10/09/2014		Michigan Motor Vehicle Dept. Dearborn Heights, MI Title #290C2820213	Title issued or updated - Registration issued or renewed - First owner reported
04/26/2015		Damage Report	Accident reported: minor damage - It hit an animal - Damage to left front <div data-bbox="850 1692 1256 1843" data-label="Figure"> <p>Damage Severity Scale</p>  <p>Minor Moderate Severe</p> </div>

CARFAX HAS THE MOST ACCIDENT & DAMAGE INFORMATION

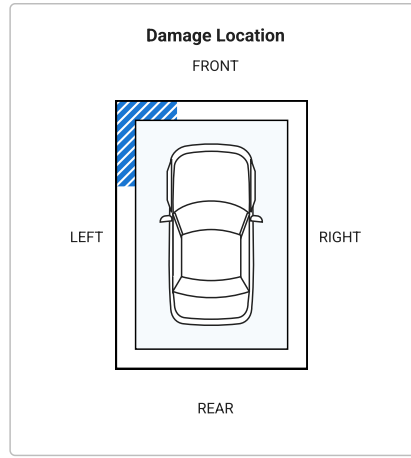

Minor damage is usually cosmetic, including dents or scratches to the vehicle body.

01/13/2016	48,958	Village Ford Dearborn, MI 313-565-3900 https://villageford.com/ ★ 4.6 / 5.0 887 Verified Reviews ♥ 10,689 Customer Favorites		Vehicle serviced - Maintenance inspection completed - Battery/charging system checked - Brakes checked - Engine oil/fluid leak checked - Tire condition and pressure checked - Turbocharger replaced/repaired
02/08/2016	51,758	Village Ford Dearborn, MI 313-565-3900 https://villageford.com/ ★ 4.6 / 5.0 887 Verified Reviews ♥ 10,689 Customer Favorites		Vehicle serviced - Maintenance inspection completed - Transfer case removed to complete repairs
10/18/2016	74,681	Village Ford Dearborn, MI 313-565-3900 https://villageford.com/ ★ 4.6 / 5.0 887 Verified Reviews ♥ 10,689 Customer Favorites		Vehicle serviced - Maintenance inspection completed - Drivability/performance checked
11/28/2016	79,450	Village Ford Dearborn, MI 313-565-3900 https://villageford.com/ ★ 4.6 / 5.0 887 Verified Reviews ♥ 10,689 Customer Favorites		Vehicle serviced - Maintenance inspection completed - Battery/charging system checked - Drivability/performance checked - Tire condition and pressure checked

03/09/2017	Damage Report	Accident reported: minor damage - Damage to left rear - Airbags did not deploy
------------	---------------	---

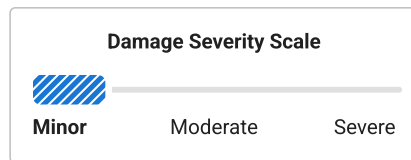

CARFAX HAS THE MOST ACCIDENT & DAMAGE INFORMATION

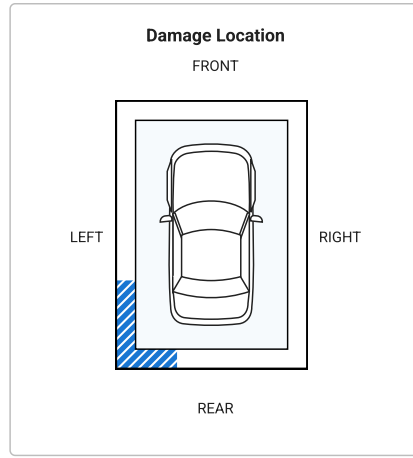

07/12/2017

Damage Report

Accident reported: minor damage with another motor vehicle
- Damage to front

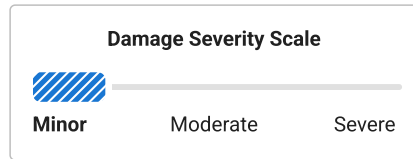

CARFAX HAS THE MOST ACCIDENT & DAMAGE INFORMATION

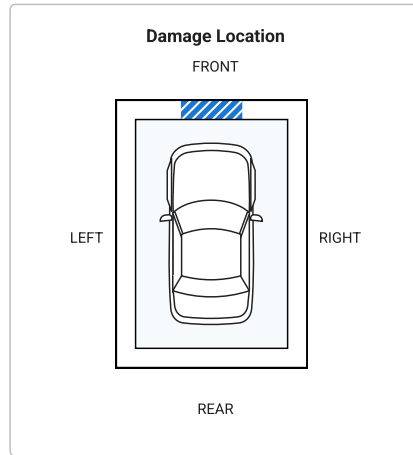

08/06/2019

Damage Report

Accident reported: minor damage with another motor vehicle
- Damage to left rear

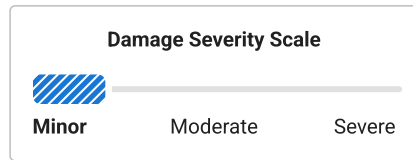

CARFAX HAS THE MOST ACCIDENT & DAMAGE INFORMATION



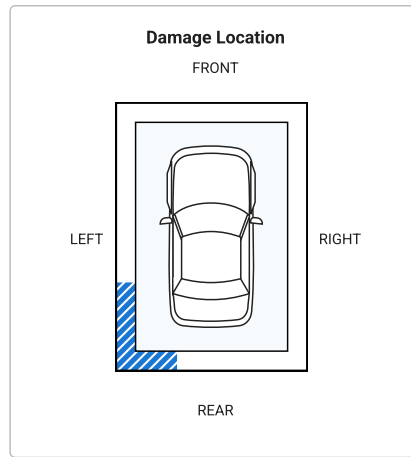

Have Questions? Consumers, please visit our Help Center at www.carfax.com. Dealers or Subscribers, please visit our Help Center at www.carfaxonline.com.

CARFAX Glossary

Accident Indicator

CARFAX receives information about accidents in all 50 states, the District of Columbia and Canada.

Not every accident is reported to CARFAX. As details about the accident become available, those additional details are added to the CARFAX Vehicle History Report. CARFAX recommends that you have this vehicle inspected by a qualified mechanic.

- According to the National Safety Council, Injury Facts, 2021 edition, 5% of the 276 million registered vehicles in the U.S. were involved in an accident in 2019. Over 77% of these were considered minor or moderate.
- This CARFAX Vehicle History Report is based only on information supplied to CARFAX and available as of 4/6/26 at 3:03:39 PM (CDT). Other information about this vehicle, including problems, may not have been reported to CARFAX. Use this report as one important tool, along with a vehicle inspection and test drive, to make a better decision about your next used car.

Damage Severity

Damage events result in one of the following severity levels:

- Minor: Generally, minor damage is cosmetic (including dents or scratches), may only require reconditioning, and typically does not compromise a vehicle's operation and/or safety.
- Moderate: Moderate damage may affect multiple components of the vehicle and may impair the vehicle's operation and/or safety.
- Severe: Severe damage usually affects multiple components of the vehicle and is likely to compromise the vehicle's operation and/or safety.

CARFAX recommends getting a pre-purchase inspection at a certified collision repair facility.

First Owner

When the first owner(s) obtains a title from a Department of Motor Vehicles as proof of ownership.

Ford or Lincoln Mercury Recall



The Ford Motor Company provides CARFAX with Field Service Action and recall information regarding safety, compliance and emissions programs announced since 2000 for a specific vehicle. For complete information regarding programs or concerns about this vehicle, please contact a local Ford or Lincoln Mercury Dealer.

Ownership History

CARFAX defines an owner as an individual or business that possesses and uses a vehicle. Not all title transactions represent changes in ownership. To provide estimated number of owners, CARFAX proprietary technology analyzes all the events in a vehicle history. Estimated ownership is available for vehicles manufactured after 1991 and titled solely in the US including Puerto Rico. Dealers sometimes opt to take ownership of a vehicle and are required to in the following states: Maine, Massachusetts, New Jersey, Ohio, Oklahoma, Pennsylvania and South Dakota. Please consider this as you review a vehicle's estimated ownership history.

Title Issued

A state issues a title to provide a vehicle owner with proof of ownership. Each title has a unique number. Each title or registration record on a CARFAX report does not necessarily indicate a change in ownership. In Canada, a registration and bill of sale are used as proof of ownership.

Follow Us:  facebook.com/CARFAX  [@CARFAXinc](https://twitter.com/CARFAXinc)  [About CARFAX](#)

CARFAX DEPENDS ON ITS SOURCES FOR THE ACCURACY AND RELIABILITY OF ITS INFORMATION. THEREFORE, NO RESPONSIBILITY IS ASSUMED BY CARFAX OR ITS AGENTS FOR ERRORS OR OMISSIONS IN THIS REPORT. CARFAX FURTHER EXPRESSLY DISCLAIMS ALL WARRANTIES, EXPRESS OR IMPLIED, INCLUDING ANY IMPLIED WARRANTIES OF MERCHANTABILITY OR FITNESS FOR A PARTICULAR PURPOSE.

© 2026 CARFAX, Inc., part of S&P Global. All rights reserved.
4/6/26 3:03:39 PM (CDT)

I have reviewed and received a copy of the CARFAX Vehicle History Report for this 2015 FORD TAURUS vehicle (VIN: 1FAHP2MT5FG121255), which is based on information supplied to CARFAX and available as of 4/6/26 at 4:03 PM (EDT).

Customer Signature

Date

Dealer Signature

Date