



Report

US \$44.99

2010 Mitsubishi Outlander ES

199,037 mi | VIN: JA4AS2AWXAZ001077 |

4 Door Wagon/Sport Utility | 2.4L I4 F DOHC 16V | Gasoline | Front wheel drive

CARFAX HAS THE MOST ACCIDENT & DAMAGE INFORMATION

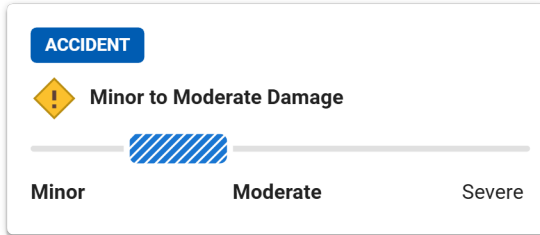

14 Service History Records

2 Previous Owners

Personal Vehicle

Last Owned in Illinois

51 Detailed Records Available

This CARFAX Vehicle History Report is based only on information supplied to CARFAX and available as of 4/29/26 at 3:49:55 PM (CDT). Other information about this vehicle, including problems, may not have been reported to CARFAX. Use this report as one important tool, along with a vehicle inspection and test drive, to make a better decision about your next used car.



Accident / Damage History

Not all accidents / issues are reported to CARFAX

Event 1

11/25/2012

Accident reported

- Vehicle involved in a rear-end collision with another motor vehicle
- Airbags did not deploy

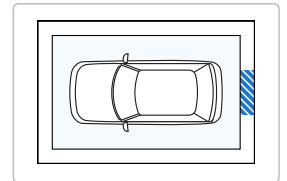

Event 2

07/02/2014

Accident reported with another motor vehicle

- It hit a parked motor vehicle

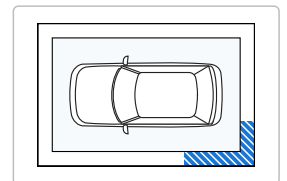

Event 3

10/25/2015

Accident reported: minor damage

- Vehicle involved in a rear-end collision with another motor vehicle

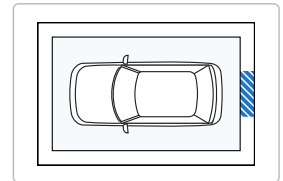
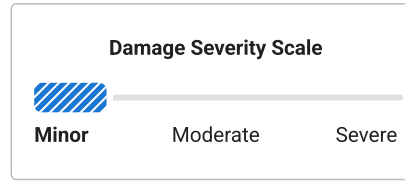

Event 4

04/16/2017

Accident reported

- It hit a parked motor vehicle

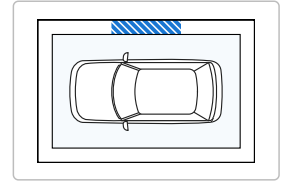

Event 5

09/08/2018

Accident reported with another motor vehicle

- Airbags did not deploy

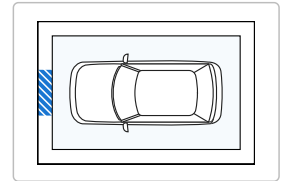





Event 6



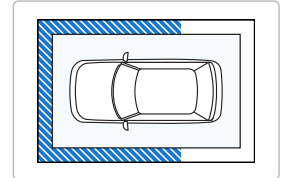
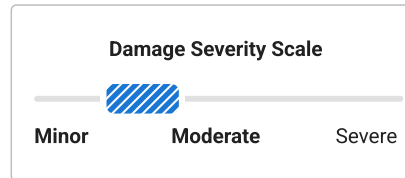





07/27/2023



Accident reported: minor to moderate damage





- Vehicle involved in a side impact collision
- Involving right front impact
- Involving right side impact
- Involving left front impact
- Involving front impact with another motor vehicle
- Airbags did not deploy



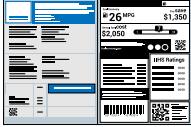

 Additional History Not all accidents / issues are reported to CARFAX	 Owner 1	 Owner 2
Total Loss No total loss reported to CARFAX.	<input checked="" type="checkbox"/> No Issues Reported	<input checked="" type="checkbox"/> No Issues Reported
Structural Damage CARFAX recommends that you have this vehicle inspected by a collision repair specialist.	<input checked="" type="checkbox"/> No Issues Reported	<input checked="" type="checkbox"/> No Issues Reported
Airbag Deployment No airbag deployment reported to CARFAX.	<input checked="" type="checkbox"/> No Issues Reported	<input checked="" type="checkbox"/> No Issues Reported
Odometer Check No indication of an odometer rollback.	<input checked="" type="checkbox"/> No Issues Indicated	<input checked="" type="checkbox"/> No Issues Indicated
Accident / Damage Accidents reported: 11/25/2012, 07/02/2014, 10/25/2015, 04/16/2017, 09/08/2018, and 07/27/2023.	<input checked="" type="checkbox"/> No Issues Reported	Accident Reported
Manufacturer Recall No open recalls reported to CARFAX.	<input checked="" type="checkbox"/> No Recalls Reported	<input checked="" type="checkbox"/> No Recalls Reported
Basic Warranty Original warranty estimated to have expired.	Warranty Expired	Warranty Expired

 Title History CARFAX guarantees the information in this section	 Owner 1	 Owner 2
Damage Brands Salvage Junk Rebuilt Fire Flood Hail Lemon	 Guaranteed No Problem	 Guaranteed No Problem
Odometer Brands Not Actual Mileage Exceeds Mechanical Limits	 Guaranteed No Problem	 Guaranteed No Problem
 GUARANTEED - None of these title problems were reported by a U.S. state Department of Motor Vehicles (DMV). If you find that any of these title problems were reported by a DMV and not included in this report, you may qualify. View Terms View Certificate		

 Ownership History The number of owners is estimated	 Owner 1	 Owner 2
Year purchased	2010	2011
Type of owner	Personal	Personal
Estimated length of ownership	11 months	15 years
Owned in the following states/provinces	Illinois	Illinois
Estimated miles driven per year	7,694/yr	14,659/yr
Last reported odometer reading	7,851	199,037

 Detailed History			
 Owner 1 Purchased: 2010	<div style="border: 1px solid #00aaff; padding: 5px; display: inline-block;"> Low mileage! This owner drove less than the industry average of 15,000 miles per year. </div>		Personal Vehicle 7,694 mi/yr
Date	Mileage	Source	Comments
10/14/2009		Mitsubishi Motors mitsubishicars.com	Vehicle manufactured - Rally red exterior - Black interior Original Window Sticker 
11/13/2009		Mitsubishi Motors mitsubishicars.com	Vehicle shipped to original dealer in Normal, IL
11/13/2009	1	O'Brien Mitsubishi Normal, IL 309-454-1222 obrienteam.com ★ 4.8 / 5.0 101 Verified Reviews ❤️ 61 Customer Favorites	Vehicle offered for sale
11/24/2009		O'Brien Mitsubishi Normal Normal, IL 309-454-1222 obrienteamnormal.com/ ★ 4.8 / 5.0 101 Verified Reviews ❤️ 61 Customer Favorites	 Vehicle serviced - Pre-delivery inspection completed
03/22/2010	159	Libertyville Mitsubishi Libertyville, IL	Vehicle sold

847-816-6660
 libertyvillemitsubishi.com
 ★ 3.4 / 5.0 5 Verified Reviews

03/31/2010		Illinois Motor Vehicle Dept. Northbrook, IL Title #X0090694417		Title issued or updated - Registration issued or renewed - First owner reported - Titled or registered as personal vehicle
07/13/2010		Illinois Motor Vehicle Dept. Northbrook, IL		Registration issued or renewed
03/02/2011	7,279	Gregory Mitsubishi Lake Villa, IL 847-816-6660 gregorymitsubishi.com/ ★ 4.5 / 5.0 56 Verified Reviews ♥ 41 Customer Favorites		Vehicle serviced - Maintenance inspection completed - Oil and filter changed
03/28/2011	7,823	McGrath Arlington Kia Palatine, IL 847-202-3900 mcgratharlingtonkia.com/search/used/?tp=used/ ★ 4.2 / 5.0 659 Verified Reviews ♥ 893 Customer Favorites		Vehicle serviced - Vehicle washed/detailed
03/29/2011	7,842	Online Listing		Vehicle offered for sale
03/31/2011	7,851	Arlington Kia in Palatine Palatine, IL 847-202-3900 arlingtonkia.com		Vehicle sold
03/31/2011		Illinois Motor Vehicle Dept.		Vehicle purchase reported
04/08/2011		McGrath Arlington Kia Palatine, IL 847-202-3900 mcgratharlingtonkia.com/search/used/?tp=used/ ★ 4.2 / 5.0 659 Verified Reviews ♥ 893 Customer Favorites		Vehicle serviced - Pre-delivery inspection completed
04/18/2011		Illinois Motor Vehicle Dept. Prospect Heights, IL		Registration issued or renewed

 **Owner 2**
Purchased: 2011

Low mileage! This owner drove less than the industry average of 15,000 miles per year.

Personal Vehicle
14,659 mi/yr

Date	Mileage	Source	Comments
04/20/2011		Illinois Motor Vehicle Dept. Prospect Heights, IL Title #X1110695119	Title issued or updated - New owner reported - Loan or lien reported - Vehicle color noted as Red
03/12/2012		Illinois Motor Vehicle Dept. Prospect Heights, IL	Registration issued or renewed
04/30/2012	22,000	Illinois Motor Vehicle Dept. Prospect Heights, IL Title #X2121693480	Title issued or updated - Correction to record - Loan or lien reported - Vehicle color noted as Red

11/25/2012

Damage Report



Accident reported

- Vehicle involved in a rear-end collision with another motor vehicle
- Damage to rear
- Airbags did not deploy

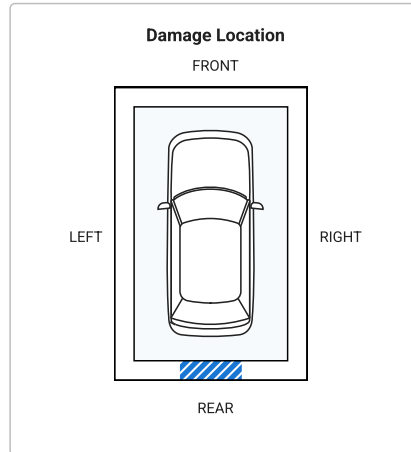

CARFAX HAS THE MOST ACCIDENT & DAMAGE INFORMATION

03/19/2013

Illinois
Motor Vehicle Dept.
Prospect Heights, IL

Registration issued or renewed

06/07/2013

Illinois
Motor Vehicle Dept.
Prospect Heights, IL

Registration issued or renewed

03/05/2014

40,000

Illinois
Inspection Station
Lincolnshire, IL

Passed emissions inspection

04/02/2014

Illinois
Motor Vehicle Dept.
Prospect Heights, IL

Registration issued or renewed

07/02/2014

Damage Report



Accident reported with another motor vehicle

- It hit a parked motor vehicle
- Damage to left rear

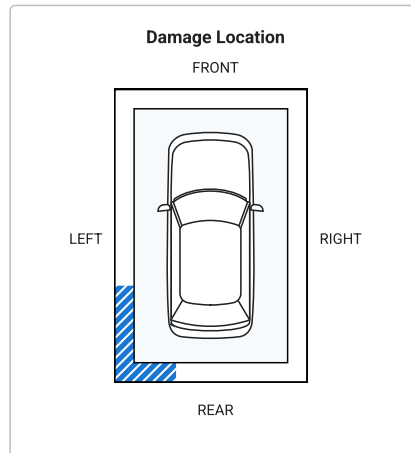

CARFAX HAS THE MOST ACCIDENT & DAMAGE INFORMATION

01/15/2015

48,904

Sears Auto Center
Niles, IL
847-803-7528
searsauto.com
★ 3.9 / 5.0 64 Verified Reviews



Vehicle serviced

- Maintenance inspection completed
- Oil and filter changed

03/31/2015

Illinois
Motor Vehicle Dept.
Prospect Heights, IL

Registration issued or renewed

05/29/2015

52,494

Sears Auto Center
Niles, IL



Vehicle serviced

- Maintenance inspection completed

847-803-7528
searsauto.com
★ 3.9 / 5.0 64 Verified Reviews

- Oil and filter changed

10/22/2015 58,367

Casey Automotive
Arlington Heights, IL
847-255-1900
caseyautomotive.com
★ 4.9 / 5.0 456 Verified Reviews
♥ 95 Customer Favorites



Vehicle serviced
- Air filter replaced
- Cabin air filter replaced/cleaned
- Oil and filter changed

10/25/2015

Damage Report

Accident reported: minor damage
- Vehicle involved in a rear-end collision with another motor vehicle
- Damage to rear

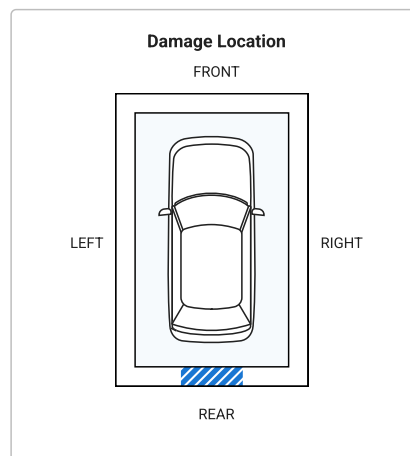
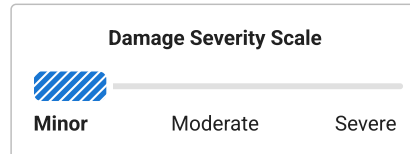

**CARFAX HAS THE MOST
ACCIDENT & DAMAGE
INFORMATION**

11/04/2015 59,133

Glenview Mitsubishi
Glenview, IL
847-832-1400
glenviewmitsubishi.com/search/used/tp/?utm_campaign=carfaxadpack
★ 4.1 / 5.0 20 Verified Reviews



Vehicle serviced

04/08/2016 68,000

Illinois
Inspection Station
Lincolnshire, IL

Passed emissions inspection

04/12/2016

Illinois
Motor Vehicle Dept.
Prospect Heights, IL

Registration issued or renewed

04/16/2017

Damage Report



Accident reported
- It hit a parked motor vehicle
- Damage to right side

**CARFAX HAS THE MOST
ACCIDENT & DAMAGE
INFORMATION**

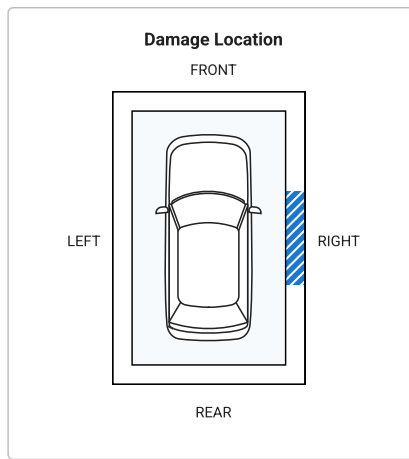

05/11/2017

Illinois
Motor Vehicle Dept.
Prospect Heights, IL

Registration issued or renewed

01/26/2018

101,000

Illinois
Inspection Station
Lincolnshire, IL

Passed emissions inspection

01/31/2018

Illinois
Motor Vehicle Dept.
Prospect Heights, IL

Registration issued or renewed

09/08/2018

Damage Report



Accident reported with another motor vehicle
- Damage to front
- Airbags did not deploy

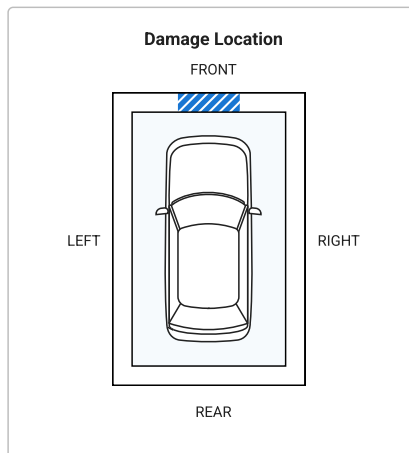

**CARFAX HAS THE MOST
ACCIDENT & DAMAGE
INFORMATION**

04/24/2019

Illinois
Motor Vehicle Dept.
Prospect Heights, IL

Registration issued or renewed

05/06/2019

Mitsubishi Motors
mitsubishicars.com
★ 4.0 / 5.0 330 Verified Reviews
♥ 3,221 Customer Favorites



Vehicle serviced
- Oil and filter changed

02/20/2020

138,000

Illinois
Inspection Station
Lincolnshire, IL

Passed emissions inspection

02/24/2020

Illinois
Motor Vehicle Dept.
Prospect Heights, IL

Registration issued or renewed
- Correction to record





04/30/2020

Amerimex Mufflers & Brakes
Oak Lawn, IL
847-520-2525
★ 4.6 / 5.0 50 Verified Reviews

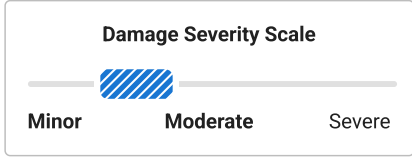
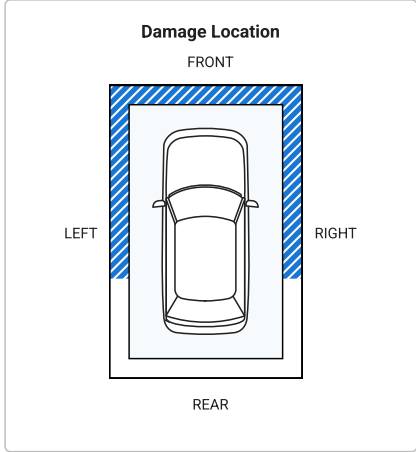

Vehicle serviced
- Catalytic converter replaced

♥ 104 Customer Favorites

04/13/2021		Illinois Motor Vehicle Dept. Prospect Heights, IL		Registration issued or renewed
05/07/2021	163,064	Mitsubishi Motors mitsubishicars.com ★ 4.0 / 5.0 330 Verified Reviews ♥ 3,221 Customer Favorites		Vehicle serviced - Oil and filter changed
03/19/2022		Illinois Inspection Station Lincolnshire, IL		Failed emissions inspection
03/30/2022	174,000	Illinois Inspection Station Skokie, IL		Passed emissions inspection
03/31/2022		Illinois Motor Vehicle Dept. Prospect Heights, IL		Registration issued or renewed
07/27/2023		Damage Report		Accident reported: minor to moderate damage - Vehicle involved in a side impact collision - Involving right front impact - Involving right side impact - Involving left front impact - Involving front impact with another motor vehicle - Airbags did not deploy
<p>Damage Severity Scale</p>  <p>Damage Location</p> 				
09/06/2023	190,597	Just Tires Wheeling, IL 847-860-7350 justtires.com/en-us/shop/il/wheeling/000903697-60090 ★ 5.0 / 5.0 16 Verified Reviews		Vehicle serviced
12/05/2023	193,910	Take 5 Oil Change Niles, IL (847) 813-5500 https://www.take5.com/ ★ 4.7 / 5.0 146 Verified Reviews ♥ 3 Customer Favorites		Vehicle serviced - Oil and filter changed
03/01/2024		Illinois Motor Vehicle Dept.		Registration issued or renewed

CARFAX HAS THE MOST ACCIDENT & DAMAGE INFORMATION

Wheeling, IL

- Registration updated when owner moved the vehicle to a new location

05/25/2024

199,037

Take 5 Oil Change
Niles, IL
(847) 813-5500
<https://www.take5.com/>



Vehicle serviced

- Air filter replaced
- Oil and filter changed

★ **4.7 / 5.0** 146 Verified Reviews
♥ **3** Customer Favorites

Have Questions? Consumers, please visit our Help Center at www.carfax.com. Dealers or Subscribers, please visit our Help Center at www.carfaxonline.com.



Glossary

Accident Indicator

CARFAX receives information about accidents in all 50 states, the District of Columbia and Canada.

Not every accident is reported to CARFAX. As details about the accident become available, those additional details are added to the CARFAX Vehicle History Report. CARFAX recommends that you have this vehicle inspected by a qualified mechanic.

- According to the National Safety Council, Injury Facts, 2021 edition, 5% of the 276 million registered vehicles in the U.S. were involved in an accident in 2019. Over 77% of these were considered minor or moderate.
- This CARFAX Vehicle History Report is based only on information supplied to CARFAX and available as of 4/29/26 at 3:49:55 PM (CDT). Other information about this vehicle, including problems, may not have been reported to CARFAX. Use this report as one important tool, along with a vehicle inspection and test drive, to make a better decision about your next used car.

Damage Severity

Damage events result in one of the following severity levels:

- Minor: Generally, minor damage is cosmetic (including dents or scratches), may only require reconditioning, and typically does not compromise a vehicle's operation and/or safety.
- Moderate: Moderate damage may affect multiple components of the vehicle and may impair the vehicle's operation and/or safety.
- Severe: Severe damage usually affects multiple components of the vehicle and is likely to compromise the vehicle's operation and/or safety.

CARFAX recommends getting a pre-purchase inspection at a certified collision repair facility.

Failed Emissions Inspection

The emissions check performed during a vehicle inspection indicated the vehicle was emitting more than allowable emissions standards and/or had missing or modified parts. Repeated failed emissions records can indicate engine problems and CARFAX recommends you have the vehicle inspected.

First Owner

When the first owner(s) obtains a title from a Department of Motor Vehicles as proof of ownership.

New Owner Reported

When a vehicle is sold to a new owner, the Title must be transferred to the new owner(s) at a Department of Motor Vehicles.

Ownership History

CARFAX defines an owner as an individual or business that possesses and uses a vehicle. Not all title transactions represent changes in ownership. To provide estimated number of owners, CARFAX proprietary technology analyzes all the events in a vehicle history. Estimated ownership is available for vehicles manufactured after 1991 and titled solely in the US including Puerto Rico. Dealers sometimes opt to take ownership of a vehicle and are required to in the following states: Maine, Massachusetts, New Jersey, Ohio, Oklahoma, Pennsylvania and South Dakota. Please consider this as you review a vehicle's estimated ownership history.

Title Issued

A state issues a title to provide a vehicle owner with proof of ownership. Each title has a unique number. Each title or registration record on a CARFAX report does not necessarily indicate a change in ownership. In Canada, a registration and bill of sale are used as proof of ownership.

Follow Us:



facebook.com/CARFAX



[@CARFAXinc](https://twitter.com/CARFAXinc)



[About CARFAX](#)

CARFAX DEPENDS ON ITS SOURCES FOR THE ACCURACY AND RELIABILITY OF ITS INFORMATION. THEREFORE, NO RESPONSIBILITY IS ASSUMED BY CARFAX OR ITS AGENTS FOR ERRORS OR OMISSIONS IN THIS REPORT. CARFAX FURTHER EXPRESSLY DISCLAIMS ALL WARRANTIES, EXPRESS OR IMPLIED, INCLUDING ANY IMPLIED WARRANTIES OF MERCHANTABILITY OR FITNESS FOR A PARTICULAR PURPOSE.

© 2026 CARFAX, Inc., part of S&P Global. All rights reserved.
4/29/26 3:49:55 PM (CDT)

I have reviewed and received a copy of the CARFAX Vehicle History Report for this 2010 MITSUBISHI OUTLANDER vehicle (VIN: JA4AS2AWXAZ001077), which is based on information supplied to CARFAX and available as of 4/29/26 at 4:49 PM (EDT).

Customer Signature

Date

Dealer Signature

Date