



History-Based Value Report

History events affecting this vehicle's value



Service History



Personal Vehicle



Open Recall



Minor Damage

\$5,700 Retail Value



Vehicle History Report™

US \$44.99

2010 DODGE GRAND CARAVAN C/V

VIN: 2D4RN1AE1AR463011
 CARGO VAN
 3.3L V6 F OHV 12V
 GASOLINE
 FRONT WHEEL DRIVE

Accident reported: minor damage

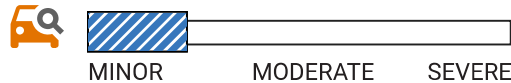

32 Service history records

At least 1 open recall

3 Previous owners

144,840 Last reported odometer reading

This CARFAX Vehicle History Report is based only on information supplied to CARFAX and available as of 9/16/23 at 7:11:20 AM (CDT). Other information about this vehicle, including problems, may not have been reported to CARFAX. Use this report as one important tool, along with a vehicle inspection and test drive, to make a better decision about your next used car.

 Ownership History The number of owners is estimated	Owner 1	Owner 2	Owner 3
Year purchased	2010	2016	2017
Type of owner	Personal	Personal	Personal
Estimated length of ownership	4 yrs. 11 mo.	1 yr. 5 mo.	5 yrs. 10 mo.
Owned in the following states/provinces	Rhode Island	Massachusetts, New York	New York
Estimated miles driven per year	12,510/yr	17,359/yr	10,505/yr
Last reported odometer reading	61,796	86,799	144,840

 Title History CARFAX guarantees the information in this section	Owner 1	Owner 2	Owner 3
Damage Brands Salvage Junk Rebuilt Fire Flood Hail Lemon	<input checked="" type="checkbox"/> Guaranteed No Problem	<input checked="" type="checkbox"/> Guaranteed No Problem	<input checked="" type="checkbox"/> Guaranteed No Problem
Odometer Brands Not Actual Mileage Exceeds Mechanical Limits	<input checked="" type="checkbox"/> Guaranteed No Problem	<input checked="" type="checkbox"/> Guaranteed No Problem	<input checked="" type="checkbox"/> Guaranteed No Problem



GUARANTEED - None of these major title problems were reported by a state Department of Motor Vehicles (DMV). If you find that any of these title problems were reported by a DMV and not included in this report, CARFAX will buy this vehicle back.
View Terms | View Certificate

 Additional History Not all accidents / issues are reported to CARFAX	Owner 1	Owner 2	Owner 3
Total Loss No total loss reported to CARFAX.	<input checked="" type="checkbox"/> No Issues Reported	<input checked="" type="checkbox"/> No Issues Reported	<input checked="" type="checkbox"/> No Issues Reported
Structural Damage CARFAX recommends that you have this vehicle inspected by a collision repair specialist.	<input checked="" type="checkbox"/> No Issues Reported	<input checked="" type="checkbox"/> No Issues Reported	<input checked="" type="checkbox"/> No Issues Reported
Airbag Deployment No airbag deployment reported to CARFAX.	<input checked="" type="checkbox"/> No Issues Reported	<input checked="" type="checkbox"/> No Issues Reported	<input checked="" type="checkbox"/> No Issues Reported

Odometer Check No indication of an odometer rollback.	No Issues Indicated	No Issues Indicated	No Issues Indicated
Accident / Damage Accidents reported: 05/14/2012 and 06/06/2014.	Minor Damage	No New Issues Reported	No New Issues Reported
Manufacturer Recall At least 1 manufacturer recall requires repair.	Recall Reported	No New Recalls Reported	No New Recalls Reported
Basic Warranty Original warranty estimated to have expired.	Warranty Expired	Warranty Expired	Warranty Expired



Detailed History







Owner 1
Purchased: 2010





Low mileage! This owner drove less than the industry average of 15,000 miles per year.

Personal Vehicle
12,510 mi/yr

Date	Mileage	Source	Comments
11/10/2010		Elmwood Dodge East Providence, RI 401-438-0400 elmwooddodge.net ★ 4.4 / 5.0 199 Verified Reviews ❤️ 160 Customer Favorites	Vehicle offered for sale
11/12/2010	6	Elmwood Dodge East Providence, RI 401-438-0400 elmwooddodge.net ★ 4.4 / 5.0 199 Verified Reviews ❤️ 160 Customer Favorites	Vehicle serviced Pre-delivery inspection completed
12/02/2010		Elmwood Auto Group Inc E Providence, RI 401-680-4841 elmwooddodge.net ★ 4.4 / 5.0 199 Verified Reviews ❤️ 160 Customer Favorites	Vehicle serviced Pre-delivery inspection completed

12/10/2010	10	Elmwood Dodge East Providence, RI 401-438-0400 elmwooddodge.net ★ 4.4 / 5.0 199 Verified Reviews ❤️ 160 Customer Favorites		Vehicle sold
12/10/2010		Rhode Island Motor Vehicle Dept.		Vehicle purchase reported
12/11/2010	25	Elmwood Auto Group Inc E Providence, RI 401-680-4841 elmwooddodge.net ★ 4.4 / 5.0 199 Verified Reviews ❤️ 160 Customer Favorites		Vehicle serviced
01/13/2011		Rhode Island Motor Vehicle Dept. Warwick, RI Title #06249768		Title issued or updated Registration issued or renewed First owner reported Titled or registered as personal vehicle Vehicle color noted as White
03/01/2011	3,090	Elmwood Dodge East Providence, RI 401-438-0400 elmwooddodge.net ★ 4.4 / 5.0 199 Verified Reviews ❤️ 160 Customer Favorites		Vehicle serviced Maintenance inspection completed Oil and filter changed
06/21/2011	7,596	Elmwood Dodge East Providence, RI 401-438-0400 elmwooddodge.net ★ 4.4 / 5.0 199 Verified Reviews ❤️ 160 Customer Favorites		Vehicle serviced Maintenance inspection completed Oil and filter changed Engine checked Remote start installed Anti-theft/keyless device/alarm installed
07/22/2011	7,700	Elmwood Dodge East Providence, RI 401-438-0400 elmwooddodge.net ★ 4.4 / 5.0 199 Verified Reviews ❤️ 160 Customer Favorites		Vehicle serviced

08/23/2011	Elmwood Auto Group Inc E Providence, RI 401-680-4841 elmwooddodge.net ★ 4.4 / 5.0 199 Verified Reviews ❤️ 160 Customer Favorites	 Vehicle serviced
10/13/2011	Rhode Island Motor Vehicle Dept. Warwick, RI	Registration issued or renewed Vehicle color noted as White
11/02/2011 12,598	Elmwood Dodge East Providence, RI 401-438-0400 elmwooddodge.net ★ 4.4 / 5.0 199 Verified Reviews ❤️ 160 Customer Favorites	 Vehicle serviced Maintenance inspection completed Tires rotated Oil and filter changed
12/27/2011	Rhode Island Motor Vehicle Dept. Warwick, RI	Registration issued or renewed Vehicle color noted as White
05/14/2012	Damage Report	 Accident reported: minor damage Vehicle involved in a single vehicle collision It hit an animal Damage to right front Damage to front Airbags did not deploy



CARFAX HAS THE MOST ACCIDENT & DAMAGE INFORMATION

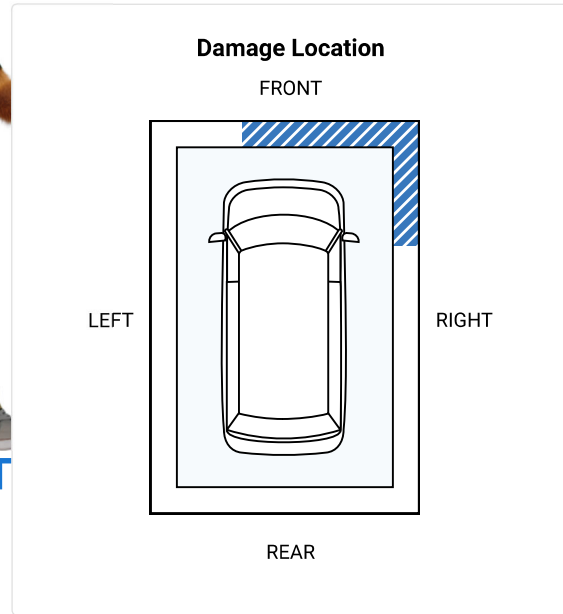
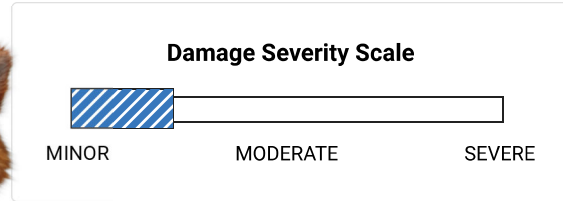

Minor damage is usually cosmetic, including dents or scratches to the vehicle body.

10/09/2012 26,037	Elmwood Dodge East Providence, RI 401-438-0400 elmwooddodge.net		Vehicle serviced Maintenance inspection completed Tires rotated Oil and filter changed Emissions or safety inspection performed
	★ 4.4 / 5.0 199 Verified Reviews ♥ 160 Customer Favorites		
05/13/2013 33,999	Elmwood Dodge East Providence, RI 401-438-0400 elmwooddodge.net		Vehicle serviced Maintenance inspection completed Oil and filter changed Rear brakes replaced
	★ 4.4 / 5.0 199 Verified Reviews ♥ 160 Customer Favorites		
02/03/2014	Rhode Island Motor Vehicle Dept. Warwick, RI		Registration issued or renewed Vehicle color noted as White

06/06/2014

Damage Report



Accident reported: minor damage

Vehicle involved in a rear-end collision
 Damage to left rear
 Damage to rear
 Airbags did not deploy



CARFAX HAS THE MOST ACCIDENT & DAMAGE INFORMATION

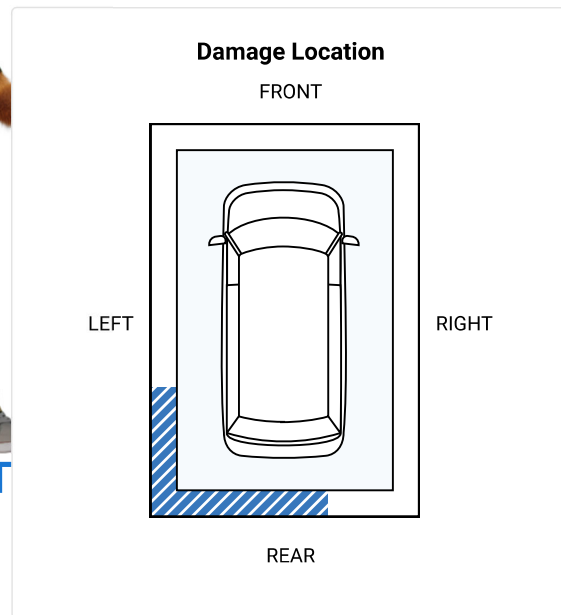

Minor damage is usually cosmetic, including dents or scratches to the vehicle body.

06/11/2014

FCA US LLC

Manufacturer Safety recall issued

NHTSA #14V-234
 Recall #P25 REAR QUARTER VENT WINDOW SWITCH
 Status: Remedy available





Click here for a copy of the owner letter for this Recall or call 1-800-853-1403 if you have any questions or need additional information on this recall.





⊖ **Learn more about this recall**





Description: THE REAR QUARTER VENT WINDOW SWITCH ON YOUR VEHICLE MAY OVERHEAT IF EXPOSED TO LIQUID MOISTURE.

AN OVERHEATED REAR QUARTER VENT WINDOW SWITCH MAY CAUSE A BURNING ODOR, SMOKE, OR A DRIVERS DOOR FIRE WITHOUT WARNING.

Remedy: THE REAR QUARTER VENT WINDOW SWITCH MUST BE REPLACED ON ALL INVOLVED VEHICLES.



09/12/2014	53,987	Bald Hill Dodge Chrysler Kia Warwick, RI 401-828-3700 baldhill.com ★ 4.5 / 5.0 678 Verified Reviews ❤️ 6,826 Customer Favorites		Vehicle serviced Maintenance inspection completed
09/22/2014	54,987	Elmwood Dodge East Providence, RI 401-438-0400 elmwooddodge.net ★ 4.4 / 5.0 199 Verified Reviews ❤️ 160 Customer Favorites		Vehicle serviced Maintenance inspection completed
12/02/2014	57,690	Elmwood Dodge East Providence, RI 401-438-0400 elmwooddodge.net ★ 4.4 / 5.0 199 Verified Reviews ❤️ 160 Customer Favorites		Vehicle serviced Maintenance inspection completed Alignment performed Three tires mounted Emissions or safety inspection performed
01/17/2015	59,079	Elmwood Dodge East Providence, RI 401-438-0400 elmwooddodge.net ★ 4.4 / 5.0 199 Verified Reviews ❤️ 160 Customer Favorites		Vehicle serviced Maintenance inspection completed Oil and filter changed
06/04/2015	61,381	Elmwood Dodge East Providence, RI 401-438-0400 elmwooddodge.net ★ 4.4 / 5.0 199 Verified Reviews ❤️ 160 Customer Favorites		Vehicle serviced Maintenance inspection completed



11/17/2015	61,796	Dealer Inventory		Vehicle offered for sale
	Owner 2 Purchased: 2016			Personal Vehicle 17,359 mi/yr
Date	Mileage	Source		Comments
05/28/2016	61,830	Massachusetts Motor Vehicle Dept.		Vehicle purchase reported
06/06/2016		Massachusetts Motor Vehicle Dept. Dorchester, MA		Registration issued or renewed Vehicle color noted as White
06/10/2016	61,952	Massachusetts Inspection Station Dorchester, MA		Passed safety inspection Passed emissions inspection
06/24/2016		Massachusetts Motor Vehicle Dept. Dorchester, MA Title #BR379657		Title issued or updated New owner reported Vehicle color noted as White
09/11/2016	64,599	Valvoline Instant Oil Change Poughkeepsie, NY 845-471-5696 vioc.com ★ 4.6 / 5.0 223 Verified Reviews ❤️ 306 Customer Favorites		Vehicle serviced Antifreeze/coolant flushed/changed Power steering fluid flushed/changed Air filter replaced Oil and filter changed
12/29/2016	68,802	Valvoline Instant Oil Change Brookline, MA 617-739-2490 vioc.com ★ 4.7 / 5.0 168 Verified Reviews ❤️ 304 Customer Favorites		Vehicle serviced Oil and filter changed Transmission fluid changed
01/10/2017	69,572	Dorchester Tire Dorchester, MA 617-436-0900 ★ 4.8 / 5.0 98 Verified Reviews ❤️ 159 Customer Favorites		Vehicle serviced



05/25/2017	75,310	<p>Valvoline Instant Oil Change Brookline, MA 617-739-2490 vioc.com</p> <p>★ 4.7 / 5.0 168 Verified Reviews ❤️ 304 Customer Favorites</p>	 <p>Vehicle serviced Oil and filter changed Air filter replaced</p>
06/06/2017	75,619	<p>Massachusetts Inspection Station Dorchester, MA</p>	<p>Failed safety inspection Passed emissions inspection</p>
06/06/2017	75,691	<p>Dorchester Tire Dorchester, MA 617-436-0900</p> <p>★ 4.8 / 5.0 98 Verified Reviews ❤️ 159 Customer Favorites</p>	 <p>Vehicle serviced Safety inspection performed Tire(s) replaced Tire condition and pressure checked</p>
06/09/2017		<p>Massachusetts Inspection Station Dorchester, MA</p>	<p>Passed safety inspection Passed emissions inspection</p>
06/21/2017	75,972	<p>Midas Brookline, MA 617-731-6212 midas.com</p> <p>★ 4.6 / 5.0 57 Verified Reviews ❤️ 65 Customer Favorites</p>	 <p>Vehicle serviced Maintenance inspection completed Wipers/washers checked Brake pads replaced Rear brake rotor(s) replaced Wiper(s) replaced Brakes replaced Rear brake pads replaced Front brake pads replaced Brakes checked</p>
06/25/2017	80,000	<p>Sears Auto Center Nanuet, NY 845-627-4581 searsauto.com</p> <p>★ 4.4 / 5.0 64 Verified Reviews</p>	 <p>Vehicle serviced Maintenance inspection completed Steering/suspension checked Alignment performed Tie rod(s) replaced</p>
10/26/2017		<p>New York Motor Vehicle Dept. Poughkeepsie, NY</p>	<p>Registration issued or renewed Titled or registered as personal vehicle Passed safety inspection</p>



11/02/2017	86,786	Valvoline Instant Oil Change Poughkeepsie, NY 845-471-5696 vioc.com ★ 4.6 / 5.0 223 Verified Reviews ♥ 306 Customer Favorites	 Vehicle serviced Oil and filter changed Tires rotated
------------	--------	---	--

11/04/2017	86,799	New York Inspection Station	Passed safety inspection Passed emissions inspection
------------	--------	-----------------------------	--

 Owner 3 Purchased: 2017		Low mileage! This owner drove less than the industry average of 15,000 miles per year.	Personal Vehicle 10,505 mi/yr
---	---	---	----------------------------------

Date	Mileage	Source	Comments
11/07/2017		New York Motor Vehicle Dept. Poughkeepsie, NY	Title issued or updated New owner reported
12/13/2017		Friendly Honda Poughkeepsie, NY 845-454-2400 friendlyhonda.net ★ 4.8 / 5.0 450 Verified Reviews ♥ 3,430 Customer Favorites	 Vehicle serviced
05/24/2018	93,607	Valvoline Instant Oil Change Poughkeepsie, NY 845-471-5696 vioc.com ★ 4.6 / 5.0 223 Verified Reviews ♥ 306 Customer Favorites	 Vehicle serviced Oil and filter changed
04/05/2019	109,098	Valvoline Instant Oil Change Poughkeepsie, NY 845-471-5696 vioc.com ★ 4.6 / 5.0 223 Verified Reviews ♥ 306 Customer Favorites	 Vehicle serviced Power steering fluid flushed/changed Oil and filter changed Air filter replaced

04/05/2019	109,101	New York Inspection Station	Passed safety inspection Passed emissions inspection
07/29/2019	115,717	Arlington Auto & Tire Poughkeepsie, NY 845-471-2800 https://arlingtonautotire.com/ ★ 4.5 / 5.0 358 Verified Reviews ❤️ 2,383 Customer Favorites	 Vehicle serviced Antifreeze/coolant flushed/changed Engine/powertrain computer/module checked
08/02/2019	115,969	Valvoline Instant Oil Change Poughkeepsie, NY 845-471-5696 vioc.com ★ 4.6 / 5.0 223 Verified Reviews ❤️ 306 Customer Favorites	 Vehicle serviced Oil and filter changed
10/25/2019		New York Motor Vehicle Dept. Poughkeepsie, NY	Registration issued or renewed Titled or registered as personal vehicle Passed safety inspection
11/20/2020	129,653	New York Inspection Station	Passed safety inspection Passed emissions inspection
11/01/2021		New York Motor Vehicle Dept. Poughkeepsie, NY	Registration issued or renewed Titled or registered as personal vehicle Passed safety inspection
01/10/2022	134,800	Valvoline Instant Oil Change Poughkeepsie, NY 845-471-5696 vioc.com ★ 4.6 / 5.0 223 Verified Reviews ❤️ 306 Customer Favorites	 Vehicle serviced Oil and filter changed Front wiper blades/refills replaced

02/14/2022	134,926	Valvoline Instant Oil Change Poughkeepsie, NY 845-471-5696 vioc.com ★ 4.6 / 5.0 223 Verified Reviews ♥ 306 Customer Favorites		Vehicle serviced Emissions inspection performed
02/14/2022		New York Inspection Station		Passed safety inspection Passed emissions inspection
10/27/2022	142,055	Arlington Auto & Tire Poughkeepsie, NY 845-471-2800 https://arlingtonautotire.com/ ★ 4.5 / 5.0 358 Verified Reviews ♥ 2,383 Customer Favorites		Vehicle serviced Drivability/performance checked Brake fluid flushed/changed Brakes serviced Rear brake pads replaced Oil and filter changed Brakes checked
04/08/2023	144,811	Arlington Auto & Tire Poughkeepsie, NY 845-471-2800 https://arlingtonautotire.com/ ★ 4.5 / 5.0 358 Verified Reviews ♥ 2,383 Customer Favorites		Vehicle serviced
04/08/2023	144,840	New York Inspection Station		Passed safety inspection Passed emissions inspection

Have Questions? Consumers, please visit our Help Center at www.carfax.com. Dealers or Subscribers, please visit our Help Center at www.carfaxonline.com.



Glossary

Accident Indicator

CARFAX receives information about accidents in all 50 states, the District of Columbia and Canada.

Not every accident is reported to CARFAX. As details about the accident become available, those additional details are added to the CARFAX Vehicle History Report. CARFAX recommends that you have this vehicle inspected by a qualified mechanic.

- According to the National Safety Council, Injury Facts, 2021 edition, 5% of the 276 million registered vehicles in the U.S. were involved in an accident in 2019. Over 77% of these were considered minor or moderate.
- This CARFAX Vehicle History Report is based only on information supplied to CARFAX and available as of 9/16/23 at 7:11:20 AM (CDT). Other information about this vehicle, including problems, may not have been reported to CARFAX. Use this report as one important tool, along with a vehicle

inspection and test drive, to make a better decision about your next used car.

Damage Severity

Damage events result in one of the following severity levels:

- **Minor:** Generally, minor damage is cosmetic (including dents or scratches), may only require reconditioning, and typically does not compromise a vehicle's operation and/or safety.
- **Moderate:** Moderate damage may affect multiple components of the vehicle and may impair the vehicle's operation and/or safety.
- **Severe:** Severe damage usually affects multiple components of the vehicle and is likely to compromise the vehicle's operation and/or safety.

CARFAX recommends getting a pre-purchase inspection at a certified collision repair facility.

First Owner

When the first owner(s) obtains a title from a Department of Motor Vehicles as proof of ownership.

Manufacturer Recall

Automobile manufacturers issue recall notices to inform vehicle owners of a safety defect or failure to meet minimum federal safety or emissions standards. Manufacturer recalls are repaired at no cost to the customer.

New Owner Reported



When a vehicle is sold to a new owner, the Title must be transferred to the new owner(s) at a Department of Motor Vehicles.

Ownership History

CARFAX defines an owner as an individual or business that possesses and uses a vehicle. Not all title transactions represent changes in ownership. To provide estimated number of owners, CARFAX proprietary technology analyzes all the events in a vehicle history. Estimated ownership is available for vehicles manufactured after 1991 and titled solely in the US including Puerto Rico. Dealers sometimes opt to take ownership of a vehicle and are required to in the following states: Maine, Massachusetts, New Jersey, Ohio, Oklahoma, Pennsylvania and South Dakota. Please consider this as you review a vehicle's estimated ownership history.

Title Issued

A state issues a title to provide a vehicle owner with proof of ownership. Each title has a unique number. Each title or registration record on a CARFAX report does not necessarily indicate a change in ownership. In Canada, a registration and bill of sale are used as proof of ownership.

Follow Us:  [facebook.com/CARFAX](https://www.facebook.com/CARFAX)  [@CARFAXinc](https://twitter.com/CARFAXinc)  [About CARFAX](#)

CARFAX DEPENDS ON ITS SOURCES FOR THE ACCURACY AND RELIABILITY OF ITS INFORMATION. THEREFORE, NO RESPONSIBILITY IS ASSUMED BY CARFAX OR ITS AGENTS FOR ERRORS OR OMISSIONS IN THIS REPORT. CARFAX FURTHER EXPRESSLY DISCLAIMS ALL WARRANTIES, EXPRESS OR IMPLIED, INCLUDING ANY IMPLIED WARRANTIES OF MERCHANTABILITY OR FITNESS FOR A PARTICULAR PURPOSE.

© 2023 CARFAX, Inc., part of S&P Global. All rights reserved.
9/16/23 7:11:20 AM (CDT)

I have reviewed and received a copy of the CARFAX Vehicle History Report for this 2010 DODGE GRAND CARAVAN vehicle (VIN: 2D4RN1AE1AR463011), which is based on information supplied to CARFAX and available as of 9/16/23 at 8:11 AM (EDT).

Customer Signature

Date

Dealer Signature

Date