



History-Based Value Report

History events affecting this vehicle's value



1

1-Owner Vehicle



Service History



Personal Vehicle



Damage Brand

\$4,460 Retail Value



Vehicle History Report™

US \$44.99

2007 HONDA ODYSSEY EX

VIN: 5FNRL38477B412757
 VAN
 3.5L V6 F SOHC 24V
 GASOLINE
 FRONT WHEEL DRIVE



Branded Titles: Rebuilt, Reconstructed, Salvage



20 Service history records



CARFAX 1-Owner vehicle



Personal vehicle





Last owned in North Carolina







132,642 Last reported odometer reading

This CARFAX Vehicle History Report is based only on information supplied to CARFAX and available as of 2/23/24 at 12:02:45 PM (CST). Other information about this vehicle, including problems, may not have been reported to CARFAX. Use this report as one important tool, along with a vehicle inspection and test drive, to make a better decision about your next used car.

 Ownership History The number of owners is estimated	Owner 1
Year purchased	2006
Type of owner	Personal
Estimated length of ownership	17 yrs. 3 mo.
Owned in the following states/provinces	Indiana, North Carolina
Estimated miles driven per year	8,965/yr
Last reported odometer reading	132,642

 Title History	Owner 1
Damage Brands Salvage Junk Rebuilt Fire Flood Hail Lemon	Alert! Problem Found
Odometer Brands Not Actual Mileage Exceeds Mechanical Limits	No Problem
 ALERT! - Severe problems were reported by a state Department of Motor Vehicles (DMV). This vehicle does not qualify for the CARFAX Buyback Guarantee.	

 Additional History Not all accidents / issues are reported to CARFAX	Owner 1
Total Loss Total Loss Reported: 04/16/2014, 05/23/2014, 03/18/2015, 05/17/2016, 03/21/2017, 03/08/2018, 03/18/2019, 03/07/2020, 03/22/2021, 03/31/2022, and 02/14/2023.	Total Loss Reported
Structural Damage CARFAX recommends that you have this vehicle inspected by a collision repair specialist.	 No Issues Reported
Airbag Deployment No airbag deployment reported to CARFAX.	 No Issues Reported
Odometer Check No indication of an odometer rollback.	 No Issues Indicated



<p>Accident / Damage DMV title problems reported. Hail damage reported: 05/23/2014. Accident reported: 12/10/2023.</p>	<p>Severe Damage</p>
<p>Manufacturer Recall No open recalls reported to CARFAX. Check with an authorized Honda dealer for any open recalls.</p>	<p><input checked="" type="checkbox"/> No Recalls Reported</p>
<p>Basic Warranty Original manufacturer warranty likely voided by manufacturer.</p>	<p>Warranty Voided</p>











CARFAX Detailed History











Owner 1
Purchased: 2006

Personal Vehicle
8,965 mi/yr

Date	Mileage	Source	Comments
10/20/2006	9	Honda of Lisle Lisle, IL 630-852-7200 hondaoflisle.com ★ 4.6 / 5.0 129 Verified Reviews ❤️ 14 Customer Favorites	 Vehicle serviced Pre-delivery inspection completed
11/04/2006		Indiana Motor Vehicle Dept. Muncie, IN Title #06400223017	Title issued or updated Registration issued or renewed First owner reported Titled or registered as personal vehicle Vehicle color noted as Mauve
01/29/2007	1,201	Victory Honda Of Muncie Muncie, IN 765-282-5955 victoryhondaofmuncie.com ★ 4.7 / 5.0 332 Verified Reviews ❤️ 2,921 Customer Favorites	 Vehicle serviced Wheels checked
03/10/2007		Indiana Motor Vehicle Dept. Muncie, IN Title #06400223017	Registration issued or renewed Vehicle color noted as Mauve

11/13/2007	4,265	Victory Honda of Muncie Muncie, IN 765-282-5955 victoryhondaofmuncie.com		Vehicle serviced 5,000 mile service performed
		★ 4.7 / 5.0 332 Verified Reviews  2,921 Customer Favorites		
02/16/2008			Indiana Motor Vehicle Dept. Muncie, IN	Registration issued or renewed Vehicle color noted as Mauve
05/31/2008	6,508	Victory Honda of Muncie Muncie, IN 765-282-5955 victoryhondaofmuncie.com		Vehicle serviced 5,000 mile service performed Engine checked Tires rotated
		★ 4.7 / 5.0 332 Verified Reviews  2,921 Customer Favorites		
09/26/2008	12,871	Victory Honda of Muncie Muncie, IN 765-282-5955 victoryhondaofmuncie.com		Vehicle serviced 5,000 mile service performed
		★ 4.7 / 5.0 332 Verified Reviews  2,921 Customer Favorites		
12/13/2008	19,827	Victory Honda of Muncie Muncie, IN 765-282-5955 victoryhondaofmuncie.com		Vehicle serviced 5,000 mile service performed Tires rotated
		★ 4.7 / 5.0 332 Verified Reviews  2,921 Customer Favorites		
02/21/2009	25,678	Victory Honda of Muncie Muncie, IN 765-282-5955 victoryhondaofmuncie.com		Vehicle serviced
		★ 4.7 / 5.0 332 Verified Reviews  2,921 Customer Favorites		





03/01/2009		Indiana Motor Vehicle Dept. Muncie, IN		Registration issued or renewed Vehicle color noted as Mauve
05/02/2009	32,369	Victory Honda of Muncie Muncie, IN 765-282-5955 victoryhondaofmuncie.com ★ 4.7 / 5.0 332 Verified Reviews ❤️ 2,921 Customer Favorites		Vehicle serviced 5,000 mile service performed
07/11/2009	38,580	Victory Honda of Muncie Muncie, IN 765-282-5955 victoryhondaofmuncie.com ★ 4.7 / 5.0 332 Verified Reviews ❤️ 2,921 Customer Favorites		Vehicle serviced 5,000 mile service performed
03/09/2010	46,446	North Carolina Motor Vehicle Dept. Charlotte, NC Title #770804100683158		Registration issued or renewed Title or registration issued Passed safety inspection Registration updated when owner moved the vehicle to a new location
05/27/2010	47,921	Scott Clark Honda Charlotte, NC 980-224-5798 scottclarkhonda.com ★ 4.7 / 5.0 2,718 Verified Reviews ❤️ 25,138 Customer Favorites		Vehicle serviced Maintenance inspection completed Battery/charging system checked Vehicle washed/detailed
05/28/2010		Crown Honda Charlotte Charlotte, NC 704-887-5800 crownauto.com		Vehicle serviced Maintenance inspection completed Engine checked
03/19/2011	55,877	North Carolina Inspection Station Matthews, NC		Passed emissions inspection
03/22/2011		North Carolina Motor Vehicle Dept. Charlotte, NC Title #770804100683158		Registration issued or renewed



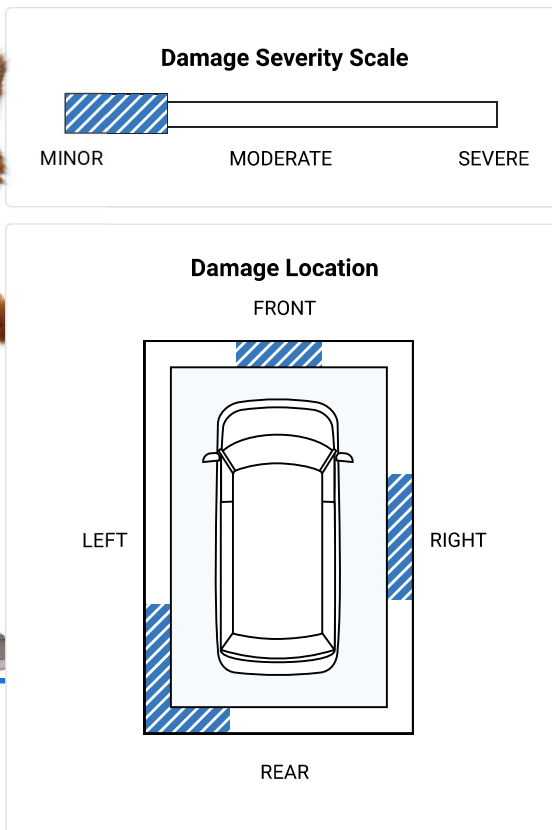



03/17/2012	65,439	North Carolina Inspection Station Matthews, NC	Passed emissions inspection
03/19/2012		North Carolina Motor Vehicle Dept. Charlotte, NC Title #770804100683158	Registration issued or renewed
03/17/2013		North Carolina Motor Vehicle Dept. Charlotte, NC Title #770804100683158	Registration issued or renewed
12/16/2013	79,554	Scott Clark Honda Charlotte, NC 980-224-5798 scottclarkhonda.com ★ 4.7 / 5.0 2,718 Verified Reviews ♥ 25,138 Customer Favorites	 Vehicle serviced Maintenance inspection completed Drivability/performance checked Vehicle washed/detailed
12/28/2013	79,936	Duval Honda Jacksonville, FL 904-387-9024 duvalhonda.com ★ 4.7 / 5.0 761 Verified Reviews ♥ 5,537 Customer Favorites	 Vehicle serviced
04/16/2014		North Carolina Motor Vehicle Dept. Charlotte, NC Title #770804100683158	 TOTAL LOSS VEHICLE SALVAGE TITLE/CERTIFICATE ISSUED
			<div style="border: 1px solid #007bff; padding: 5px;">There are many reasons an insurance company will declare a vehicle a total loss. Have this vehicle inspected by a qualified technician before you buy. Learn More</div>
05/23/2014		Damage Report	 Damage reported: minor damage Damage to front Damage to left rear Damage to right side









CARFAX HAS THE MOST ACCIDENT & DAMAGE INFORMATION



05/23/2014	Damage Report	 TOTAL LOSS VEHICLE Hail damage reported
08/26/2014 84,685	Scott Clark Honda Charlotte, NC 980-224-5798 scottclarkhonda.com ★ 4.7 / 5.0 2,718 Verified Reviews ❤️ 25,138 Customer Favorites	 Vehicle serviced Timing belt tensioner/idler replaced Serpentine belt replaced Engine checked Vehicle washed/detailed
03/18/2015	North Carolina Motor Vehicle Dept. Charlotte, NC Title #770804100683158	 TOTAL LOSS VEHICLE SALVAGE TITLE/CERTIFICATE ISSUED RECONSTRUCTED TITLE ISSUED REBUILT TITLE ISSUED
05/17/2016	North Carolina Motor Vehicle Dept. Charlotte, NC Title #770804100683158	 TOTAL LOSS VEHICLE SALVAGE TITLE/CERTIFICATE ISSUED RECONSTRUCTED TITLE ISSUED REBUILT TITLE ISSUED

03/21/2017		North Carolina Motor Vehicle Dept. Charlotte, NC Title #770804100683158		TOTAL LOSS VEHICLE SALVAGE TITLE/CERTIFICATE ISSUED RECONSTRUCTED TITLE ISSUED REBUILT TITLE ISSUED
07/28/2017	106,157	Precision Tune Auto Care Pineville, NC 704-759-0393 precisiontune.com ★ 4.4 / 5.0 101 Verified Reviews ❤️ 344 Customer Favorites		Vehicle serviced Alignment performed
11/04/2017	108,658	Precision Tune Auto Care Pineville, NC 704-759-0393 precisiontune.com ★ 4.4 / 5.0 101 Verified Reviews ❤️ 344 Customer Favorites		Vehicle serviced Alignment performed Four wheel alignment performed
11/24/2017	111,100	Precision Tune Auto Care Pineville, NC 704-759-0393 precisiontune.com ★ 4.4 / 5.0 101 Verified Reviews ❤️ 344 Customer Favorites		Vehicle serviced Four wheel alignment performed Alignment performed
03/08/2018		North Carolina Motor Vehicle Dept. Charlotte, NC Title #770804100683158		TOTAL LOSS VEHICLE SALVAGE TITLE/CERTIFICATE ISSUED RECONSTRUCTED TITLE ISSUED REBUILT TITLE ISSUED
12/18/2018	115,113	Precision Tune Auto Care Pineville, NC 704-759-0393 precisiontune.com ★ 4.4 / 5.0 101 Verified Reviews ❤️ 344 Customer Favorites		Vehicle serviced Four wheel alignment performed Alignment performed

02/23/2019	117,451	Precision Tune Auto Care Pineville, NC 704-759-0393 precisiontune.com ★ 4.4 / 5.0 101 Verified Reviews ♥ 344 Customer Favorites		Vehicle serviced Emissions system serviced Window(s) checked Emissions inspection performed Emissions or safety inspection performed
03/18/2019		North Carolina Motor Vehicle Dept. Charlotte, NC Title #770804100683158		TOTAL LOSS VEHICLE SALVAGE TITLE/CERTIFICATE ISSUED RECONSTRUCTED TITLE ISSUED REBUILT TITLE ISSUED
03/07/2020		North Carolina Motor Vehicle Dept. Charlotte, NC Title #770804100683158		TOTAL LOSS VEHICLE SALVAGE TITLE/CERTIFICATE ISSUED RECONSTRUCTED TITLE ISSUED REBUILT TITLE ISSUED
03/22/2021		North Carolina Motor Vehicle Dept. Charlotte, NC Title #770804100683158		TOTAL LOSS VEHICLE SALVAGE TITLE/CERTIFICATE ISSUED RECONSTRUCTED TITLE ISSUED REBUILT TITLE ISSUED
08/10/2021	132,642	Evans Import Service Inc Mint Hill, NC 704-545-7938 evansimportservice.com /main.aspx ★ 5.0 / 5.0 97 Verified Reviews ♥ 6 Customer Favorites		Vehicle serviced Brakes checked
03/31/2022		North Carolina Motor Vehicle Dept. Charlotte, NC Title #770804100683158		TOTAL LOSS VEHICLE SALVAGE TITLE/CERTIFICATE ISSUED RECONSTRUCTED TITLE ISSUED REBUILT TITLE ISSUED
02/14/2023		North Carolina Motor Vehicle Dept. Charlotte, NC Title #770804100683158		TOTAL LOSS VEHICLE SALVAGE TITLE/CERTIFICATE ISSUED RECONSTRUCTED TITLE ISSUED REBUILT TITLE ISSUED

12/10/2023

Damage Report



Accident reported: minor to moderate damage

Vehicle involved in a rear-end collision
 Damage to rear
 Vehicle drivable
 Airbags did not deploy



CARFAX HAS THE MOST ACCIDENT & DAMAGE INFORMATION

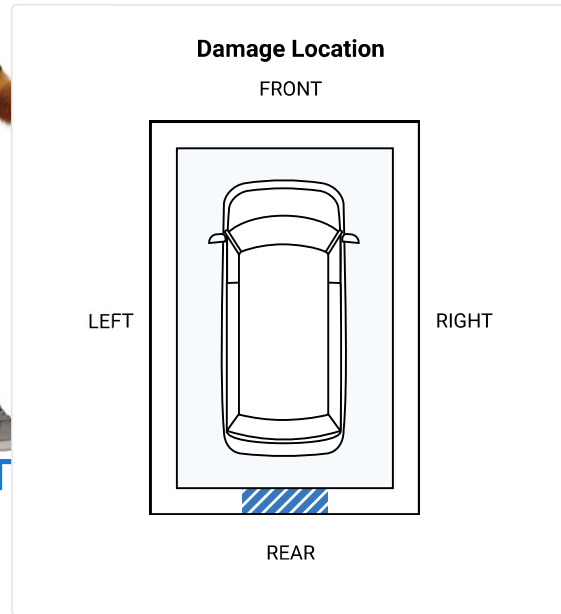
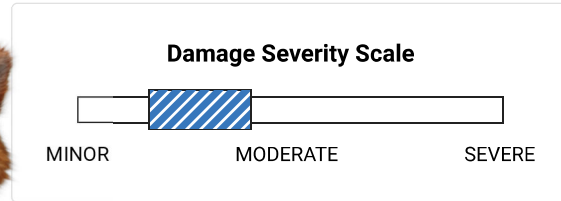

Have Questions? Consumers, please visit our Help Center at www.carfax.com. Dealers or Subscribers, please visit our Help Center at www.carfaxonline.com.



Glossary

Accident Indicator

CARFAX receives information about accidents in all 50 states, the District of Columbia and Canada.

Not every accident is reported to CARFAX. As details about the accident become available, those additional details are added to the CARFAX Vehicle History Report. CARFAX recommends that you have this vehicle inspected by a qualified mechanic.

- According to the National Safety Council, Injury Facts, 2021 edition, 5% of the 276 million registered vehicles in the U.S. were involved in an accident in 2019. Over 77% of these were considered minor or moderate.
- This CARFAX Vehicle History Report is based only on information supplied to CARFAX and available as of 2/23/24 at 12:02:45 PM (CST). Other information about this vehicle, including problems, may not have been reported to CARFAX. Use this report as one important tool, along with a vehicle inspection and test drive, to make a better decision about your next used car.

Damage Indicator

Damage can be a result of many different types of events. Examples include contact with objects (other cars, trees, traffic signs, road debris, etc), vandalism, or weather-related events. Not every damage event is reported to CARFAX. As details about the damage event become available, those additional details are added to the CARFAX Vehicle History Report. CARFAX recommends that you have this vehicle inspected by a qualified mechanic.

- This CARFAX Vehicle History Report is based only on information supplied to CARFAX and available as of 2/23/24 at 12:02:45 PM (CST). Other information about this vehicle, including problems, may not have been reported to CARFAX. Use this report as one important tool, along with a vehicle inspection and test drive, to make a better decision about your next used car.

Damage Severity

Damage events result in one of the following severity levels:

- **Minor:** Generally, minor damage is cosmetic (including dents or scratches), may only require reconditioning, and typically does not compromise a vehicle's operation and/or safety.
- **Moderate:** Moderate damage may affect multiple components of the vehicle and may impair the vehicle's operation and/or safety.
- **Severe:** Severe damage usually affects multiple components of the vehicle and is likely to compromise the vehicle's operation and/or safety.

CARFAX recommends getting a pre-purchase inspection at a certified collision repair facility.

First Owner

When the first owner(s) obtains a title from a Department of Motor Vehicles as proof of ownership.

Ownership History

CARFAX defines an owner as an individual or business that possesses and uses a vehicle. Not all title transactions represent changes in ownership. To provide estimated number of owners, CARFAX proprietary technology analyzes all the events in a vehicle history. Estimated ownership is available for vehicles manufactured after 1991 and titled solely in the US including Puerto Rico. Dealers sometimes opt to take ownership of a vehicle and are required to in the following states: Maine, Massachusetts, New Jersey, Ohio, Oklahoma, Pennsylvania and South Dakota. Please consider this as you review a vehicle's estimated ownership history.

Rebuilt/Reconstructed Title

A Rebuilt/Reconstructed vehicle is a salvage vehicle that has been repaired and restored to operation. These vehicles are often severely damaged before they are rebuilt and refurbished parts are typically used during reconstruction. In most states, an inspection of the vehicle is required before the vehicle is allowed to return to the road.

Salvage Title

A Salvage Title is issued on a vehicle damaged to the extent that the cost of repairing the vehicle exceeds approximately 75% of its pre-damage value. This damage threshold may vary by state. Some states treat Junk titles the same as Salvage but the majority use this title to indicate that a vehicle is not road worthy and cannot be titled again in that state. The following eleven states also use Salvage titles to identify stolen vehicles - AZ, FL, GA, IL, MD, MN, NJ, NM, NY, OK and OR.

Title Issued

A state issues a title to provide a vehicle owner with proof of ownership. Each title has a unique number. Each title or registration record on a CARFAX report does not necessarily indicate a change in ownership. In Canada, a registration and bill of sale are used as proof of ownership.

Total Loss Vehicle

An insurance or fleet company declares a vehicle a total loss when a claim exceeds approximately 75% of its pre-damage value or if the vehicle is stolen and not recovered. This damage threshold varies by company. These companies typically take possession and obtain the title. Not all total loss vehicles result in a DMV-reported branded title. This may occur when an insurance company's definition of a total loss is different than the state DMV's definition for a branded title or when the owner of the vehicle is a self-insured company, like a fleet or rental company.

Follow Us:



[facebook.com/CARFAX](https://www.facebook.com/CARFAX)



[@CARFAXinc](https://twitter.com/CARFAXinc)



About CARFAX

CARFAX DEPENDS ON ITS SOURCES FOR THE ACCURACY AND RELIABILITY OF ITS INFORMATION. THEREFORE, NO RESPONSIBILITY

IS ASSUMED BY CARFAX OR ITS AGENTS FOR ERRORS OR OMISSIONS IN THIS REPORT. CARFAX FURTHER EXPRESSLY DISCLAIMS ALL WARRANTIES, EXPRESS OR IMPLIED, INCLUDING ANY IMPLIED WARRANTIES OF MERCHANTABILITY OR FITNESS FOR A PARTICULAR PURPOSE.

© 2024 CARFAX, Inc., part of S&P Global. All rights reserved.
2/23/24 12:02:45 PM (CST)

I have reviewed and received a copy of the CARFAX Vehicle History Report for this 2007 HONDA ODYSSEY vehicle (VIN: 5FNRL38477B412757), which is based on information supplied to CARFAX and available as of 2/23/24 at 1:02 PM (EST).

Customer Signature

Date

Dealer Signature

Date