

Display CARFAX in online listings:

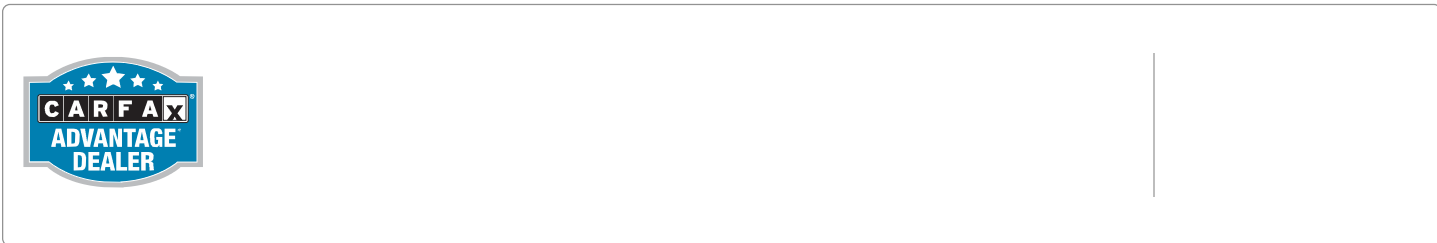

CARFAX History-Based Value Report

History events affecting this vehicle's value

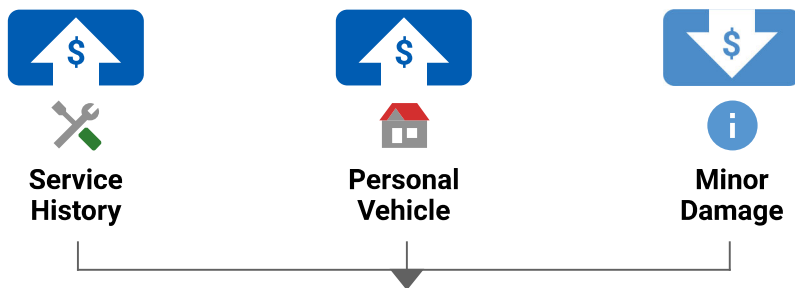

\$8,030 Retail Value



Vehicle History Report™

US \$44.99

**2012 JEEP PATRIOT
LATITUDE**

VIN: 1C4NJRFB2CD625593
4 DOOR WAGON/SPORT
UTILITY
2.4L I4 F DOHC 16V
GASOLINE
FRONT WHEEL DRIVE W/ 4X4

Damage reported: minor damage

MINOR MODERATE SEVERE

20 Service history records

3 Previous owners

Personal vehicle

117,603 Last reported odometer reading

This CARFAX Vehicle History Report is based only on information supplied to CARFAX and available as of 5/13/23 at 7:11:56 AM (CDT). Other information about this vehicle, including problems, may not have been reported to CARFAX. Use this report as one important tool, along with a vehicle inspection and test drive, to make a better decision about your next used car.

 Ownership History The number of owners is estimated	Owner 1	Owner 2	Owner 3
Year purchased	2012	2015	2020
Type of owner	Personal	Personal	Personal
Estimated length of ownership	3 yrs. 7 mo.	4 yrs. 9 mo.	2 yrs. 6 mo.
Owned in the following states/provinces	Michigan	Michigan	Michigan
Estimated miles driven per year	21,990/yr	9,641/yr	---
Last reported odometer reading	41,325	117,603	---

 Title History CARFAX guarantees the information in this section	Owner 1	Owner 2	Owner 3
Damage Brands Salvage Junk Rebuilt Fire Flood Hail Lemon	<input checked="" type="checkbox"/> Guaranteed No Problem	<input checked="" type="checkbox"/> Guaranteed No Problem	<input checked="" type="checkbox"/> Guaranteed No Problem
Odometer Brands Not Actual Mileage Exceeds Mechanical Limits	<input checked="" type="checkbox"/> Guaranteed No Problem	<input checked="" type="checkbox"/> Guaranteed No Problem	<input checked="" type="checkbox"/> Guaranteed No Problem



GUARANTEED - None of these major title problems were reported by a state Department of Motor Vehicles (DMV). If you find that any of these title problems were reported by a DMV and not included in this report, CARFAX will buy this vehicle back.
View Terms | View Certificate

 Additional History Not all accidents / issues are reported to CARFAX	Owner 1	Owner 2	Owner 3
Total Loss No total loss reported to CARFAX.	<input checked="" type="checkbox"/> No Issues Reported	<input checked="" type="checkbox"/> No Issues Reported	<input checked="" type="checkbox"/> No Issues Reported
Structural Damage CARFAX recommends that you have this vehicle inspected by a collision repair specialist.	<input checked="" type="checkbox"/> No Issues Reported	<input checked="" type="checkbox"/> No Issues Reported	<input checked="" type="checkbox"/> No Issues Reported
Airbag Deployment No airbag deployment reported to CARFAX.	<input checked="" type="checkbox"/> No Issues Reported	<input checked="" type="checkbox"/> No Issues Reported	<input checked="" type="checkbox"/> No Issues Reported

Odometer Check No indication of an odometer rollback.	No Issues Indicated	No Issues Indicated	No Issues Indicated
Accident / Damage Accident reported: 08/29/2013. Damage reported: 05/15/2020.	Very Minor Damage	Minor Damage	No New Issues Reported
Manufacturer Recall No open recalls reported to CARFAX.	No Recalls Reported	No Recalls Reported	No Recalls Reported
Basic Warranty Original warranty estimated to have expired.	Warranty Expired	Warranty Expired	Warranty Expired

CARFAX Detailed History



Owner 1
 Purchased: 2012

Personal Vehicle
 21,990 mi/yr

Date	Mileage	Source	Comments
03/14/2012		Dean Arbour Ford Jeep Pinconning, MI 989-879-2861 deanarbour.com	Vehicle offered for sale
03/15/2012	22	Dean Arbour Ford Jeep Pinconning, MI 989-879-2861 deanarbour.com	Vehicle serviced Vehicle washed/detailed
04/25/2012	236	Michigan Motor Vehicle Dept. Saint Ignace, MI Title #603A1161385	Registration issued or renewed Title or registration issued First owner reported Titled or registered as personal vehicle
05/11/2012	639	Fernelius Ford Lincoln Cheboygan, MI 231-627-9966 ferneliusfordlincoln.com / ★ 4.6 / 5.0 35 Verified Reviews	Vehicle serviced
06/08/2012		Michigan Motor Vehicle Dept. Saint Ignace, MI	Registration issued or renewed

10/29/2012 14,924 Fernelius Toyota
 Chrysler Dodge
 Cheboygan, MI
 231-627-5673
 ferneliustoyota.net
 ★ 4.7 / 5.0
 81 Verified Reviews
 ❤️ 2 Customer Favorites

 **Vehicle serviced**
 Maintenance inspection completed
 Tires rotated
 Drivability/performance checked
 Rear wheel bearing(s)/hub(s) replaced

04/09/2013 Pollards Service Center
 Indian River, MI
 231-238-9172
 ★ 4.9 / 5.0
 37 Verified Reviews
 ❤️ 33 Customer Favorites

 **Vehicle serviced**
 Oil and filter changed

05/30/2013 Michigan
 Motor Vehicle Dept.
 Saint Ignace, MI

Registration issued or renewed

08/29/2013 Damage Report

 **Accident reported: very minor damage**
 Damage to left front



CARFAX HAS THE MOST ACCIDENT & DAMAGE INFORMATION

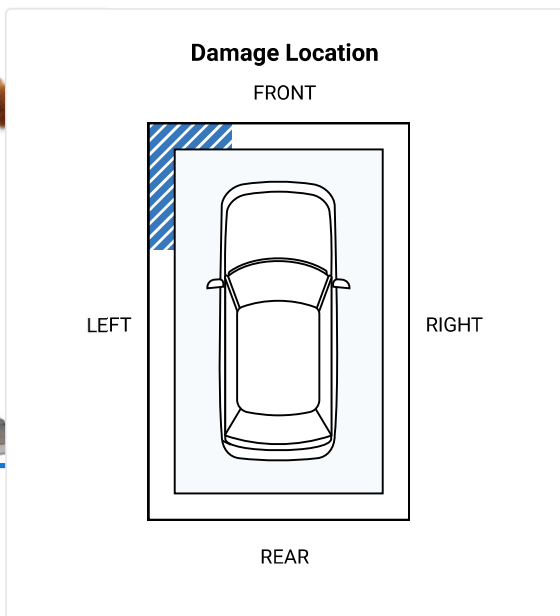
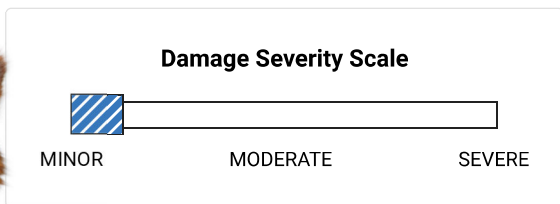



Minor damage is usually cosmetic, including dents or scratches to the vehicle body.

11/18/2013	34,961	Pollards Service Center Indian River, MI 231-238-9172 ★ 4.9 / 5.0 37 Verified Reviews ♥ 33 Customer Favorites	Vehicle serviced Oil and filter changed
03/08/2014	41,325	Grease Monkey #191 Green Bay, WI 920-468-9490 https://mycarfax.com/sign-up/grease-monkey-191 ★ 4.9 / 5.0 13 Verified Reviews ♥ 47 Customer Favorites	Vehicle serviced Maintenance inspection completed Fluids checked Oil and filter changed Body lubricated Steering/suspension lubricated
06/05/2014		Michigan Motor Vehicle Dept. Saint Ignace, MI	Registration issued or renewed
06/02/2015		Michigan Motor Vehicle Dept. Saint Ignace, MI	Registration issued or renewed
12/08/2015		Michigan Motor Vehicle Dept. Alanson, MI	Registration issued or renewed
12/09/2015		Michigan Motor Vehicle Dept. Alanson, MI	Loan or lien reported









Owner 2
Purchased: 2015









Low mileage! This owner drove less than the industry average of 15,000 miles per year.

Personal Vehicle
9,641 mi/yr

Date	Mileage	Source	Comments
12/09/2015	71,401	Michigan Motor Vehicle Dept. Alanson, MI Title #368D3420120	Title issued or updated New owner reported

05/31/2016	75,938	Pollards Service Center Indian River, MI 231-238-9172 ★ 4.9 / 5.0 37 Verified Reviews ❤️ 33 Customer Favorites		Vehicle serviced Oil and filter changed
12/07/2016	82,563	Pollards Service Center Indian River, MI 231-238-9172 ★ 4.9 / 5.0 37 Verified Reviews ❤️ 33 Customer Favorites		Vehicle serviced Oil and filter changed
12/19/2016		Michigan Motor Vehicle Dept. Alanson, MI		Registration issued or renewed
06/16/2017	88,506	Pollards Service Center Indian River, MI 231-238-9172 ★ 4.9 / 5.0 37 Verified Reviews ❤️ 33 Customer Favorites		Vehicle serviced Oil and filter changed Fluids checked Tire condition and pressure checked
11/07/2017		Pollards Service Center Indian River, MI 231-238-9172 ★ 4.9 / 5.0 37 Verified Reviews ❤️ 33 Customer Favorites		Vehicle serviced Alignment performed
12/20/2017		Michigan Motor Vehicle Dept. Alanson, MI		Registration issued or renewed
02/16/2018	94,224	Pollards Service Center Indian River, MI 231-238-9172 ★ 4.9 / 5.0 37 Verified Reviews ❤️ 33 Customer Favorites		Vehicle serviced Oil and filter changed Body lubricated Fluids checked
06/25/2018	97,915	Pollards Service Center Indian River, MI 231-238-9172 ★ 4.9 / 5.0 37 Verified Reviews ❤️ 33 Customer Favorites		Vehicle serviced Oil and filter changed Body lubricated Wiper(s) replaced Fluids checked

08/28/2018	99,554	Indian River Auto Care Indian River, MI 231-238-7891 ★ 4.9 / 5.0 15 Verified Reviews ♥ 3 Customer Favorites		Vehicle serviced
11/19/2018	101,830	Indian River Auto Care Indian River, MI 231-238-7891 ★ 4.9 / 5.0 15 Verified Reviews ♥ 3 Customer Favorites		Vehicle serviced Four tires balanced Four tires mounted
12/21/2018		Michigan Motor Vehicle Dept. Alanson, MI		Registration issued or renewed
03/18/2019	103,892	Pollards Service Center Indian River, MI 231-238-9172 ★ 4.9 / 5.0 37 Verified Reviews ♥ 33 Customer Favorites		Vehicle serviced Oil and filter changed Fluids checked Tire condition and pressure checked
04/11/2019	104,387	Indian River Auto Care Indian River, MI 231-238-7891 ★ 4.9 / 5.0 15 Verified Reviews ♥ 3 Customer Favorites		Vehicle serviced
05/21/2019	105,078	Pollards Service Center Indian River, MI 231-238-9172 ★ 4.9 / 5.0 37 Verified Reviews ♥ 33 Customer Favorites		Vehicle serviced Wheel bearing(s)/hub(s) replaced Rear wheel bearing(s)/hub(s) replaced
10/11/2019	109,521	Pollards Service Center Indian River, MI 231-238-9172 ★ 4.9 / 5.0 37 Verified Reviews ♥ 33 Customer Favorites		Vehicle serviced Oil and filter changed Fluids checked Tire condition and pressure checked

12/04/2019 110,220 Pollards Service Center
Indian River, MI
231-238-9172



Vehicle serviced

★ **4.9 / 5.0**
37 Verified Reviews
♥ **33** Customer Favorites

01/06/2020 Michigan
Motor Vehicle Dept.
Alanson, MI

Registration issued or renewed

05/15/2020 Damage Report



Damage reported: minor damage
Damage to left rear
Damage to rear



**CARFAX HAS THE MOST
ACCIDENT & DAMAGE
INFORMATION**

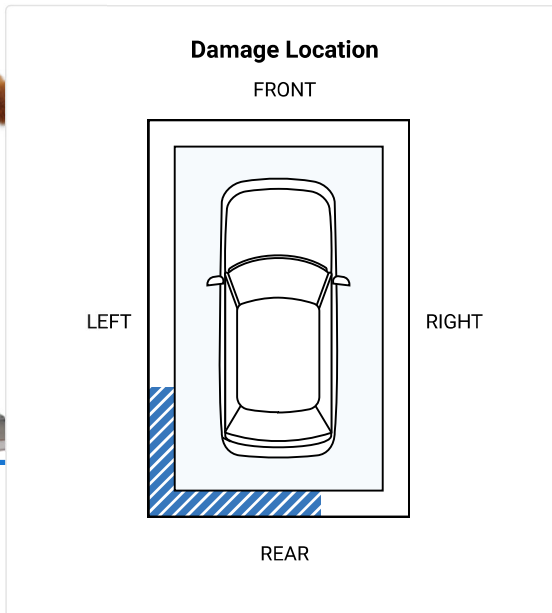
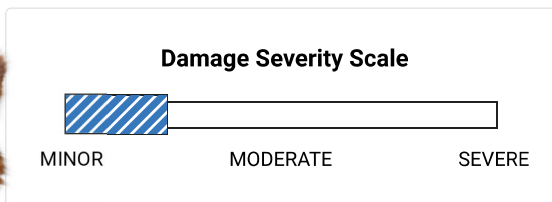



Minor damage is usually cosmetic, including dents or scratches to the vehicle body.

09/22/2020 117,601 Fernelius Ford Lincoln
Cheboygan, MI
231-627-9966
ferneliusfordlincoln.com
/

Vehicle offered for sale

★ **4.6 / 5.0**
35 Verified Reviews

09/25/2020	Fernelius Ford Lincoln Cheboygan, MI 231-627-9966 ferneliusfordlincoln.com /		Vehicle serviced Pre-delivery inspection completed Maintenance inspection completed Oil and filter changed
★ 4.6 / 5.0 35 Verified Reviews			
Looks like this dealer serviced the car in order to prepare it for sale. That's a good thing!			

10/13/2020	117,603	Fernelius Ford Lincoln Cheboygan, MI 231-627-9966 ferneliusfordlincoln.com /	Vehicle sold
★ 4.6 / 5.0 35 Verified Reviews			

10/13/2020	Michigan Motor Vehicle Dept.	Vehicle purchase reported
------------	---------------------------------	----------------------------------

10/14/2020	Michigan Motor Vehicle Dept. Charlevoix, MI	Registration issued or renewed
------------	---	---------------------------------------

	Owner 3 Purchased: 2020	Personal Vehicle
---	-----------------------------------	------------------

Date	Mileage	Source	Comments
10/14/2020		Michigan Motor Vehicle Dept. Charlevoix, MI Title #MI0007005895	Title issued or updated New owner reported
10/11/2021		Michigan Motor Vehicle Dept. Charlevoix, MI	Registration issued or renewed
10/18/2022		Michigan Motor Vehicle Dept. Charlevoix, MI	Registration issued or renewed

Have Questions? Consumers, please visit our Help Center at www.carfax.com. Dealers or Subscribers, please visit our Help Center at www.carfaxonline.com.

	Glossary
---	-----------------

Accident Indicator

CARFAX receives information about accidents in all 50 states, the District of Columbia and Canada.

Not every accident is reported to CARFAX. As details about the accident become available, those additional details are added to the CARFAX Vehicle History Report. CARFAX recommends that you have this vehicle inspected by a qualified mechanic.

- According to the National Safety Council, Injury Facts, 2021 edition, 5% of the 276 million registered vehicles in the U.S. were involved in an accident in 2019. Over 77% of these were considered minor or moderate.
- This CARFAX Vehicle History Report is based only on information supplied to CARFAX and available as of 5/13/23 at 7:11:56 AM (CDT). Other information about this vehicle, including problems, may not have been reported to CARFAX. Use this report as one important tool, along with a vehicle inspection and test drive, to make a better decision about your next used car.

Damage Indicator

Damage can be a result of many different types of events. Examples include contact with objects (other cars, trees, traffic signs, road debris, etc), vandalism, or weather-related events. Not every damage event is reported to CARFAX. As details about the damage event become available, those additional details are added to the CARFAX Vehicle History Report. CARFAX recommends that you have this vehicle inspected by a qualified mechanic.

- This CARFAX Vehicle History Report is based only on information supplied to CARFAX and available as of 5/13/23 at 7:11:56 AM (CDT). Other information about this vehicle, including problems, may not have been reported to CARFAX. Use this report as one important tool, along with a vehicle inspection and test drive, to make a better decision about your next used car.

Damage Severity

Damage events result in one of the following severity levels:

- **Minor:** Generally, minor damage is cosmetic (including dents or scratches), may only require reconditioning, and typically does not compromise a vehicle's operation and/or safety.
- **Moderate:** Moderate damage may affect multiple components of the vehicle and may impair the vehicle's operation and/or safety.
- **Severe:** Severe damage usually affects multiple components of the vehicle and is likely to compromise the vehicle's operation and/or safety.

CARFAX recommends getting a pre-purchase inspection at a certified collision repair facility.

First Owner

When the first owner(s) obtains a title from a Department of Motor Vehicles as proof of ownership.

New Owner Reported

When a vehicle is sold to a new owner, the Title must be transferred to the new owner(s) at a Department of Motor Vehicles.

Ownership History

CARFAX defines an owner as an individual or business that possesses and uses a vehicle. Not all title transactions represent changes in ownership. To provide estimated number of owners, CARFAX proprietary technology analyzes all the events in a vehicle history. Estimated ownership is available for vehicles manufactured after 1991 and titled solely in the US including Puerto Rico. Dealers sometimes opt to take ownership of a vehicle and are required to in the following states: Maine, Massachusetts, New Jersey, Ohio, Oklahoma, Pennsylvania and South Dakota. Please consider this as you review a vehicle's estimated ownership history.

Title Issued

A state issues a title to provide a vehicle owner with proof of ownership. Each title has a unique number. Each title or registration record on a CARFAX report does not necessarily indicate a change in ownership. In Canada, a registration and bill of sale are used as proof of ownership.

Follow Us:



[facebook.com/CARFAX](https://www.facebook.com/CARFAX)



[@CARFAXinc](https://twitter.com/CARFAXinc)



[About CARFAX](#)

CARFAX DEPENDS ON ITS SOURCES FOR THE ACCURACY AND RELIABILITY OF ITS INFORMATION. THEREFORE, NO RESPONSIBILITY IS ASSUMED BY CARFAX OR ITS AGENTS FOR ERRORS OR OMISSIONS IN THIS REPORT. CARFAX FURTHER EXPRESSLY DISCLAIMS ALL WARRANTIES, EXPRESS OR IMPLIED, INCLUDING ANY IMPLIED WARRANTIES OF MERCHANTABILITY OR FITNESS FOR A PARTICULAR PURPOSE.

© 2023 CARFAX, Inc., part of S&P Global. All rights reserved.
5/13/23 7:11:56 AM (CDT)

I have reviewed and received a copy of the CARFAX Vehicle History Report for this 2012 JEEP PATRIOT vehicle (VIN: 1C4NJRFB2CD625593), which is based on information supplied to CARFAX and available as of 5/13/23 at 8:11 AM (EDT).

Customer Signature

Date

Dealer Signature

Date