



History-Based Value Report

History events affecting this vehicle's value



Personal Vehicle



Minor Damage

\$8,060 Retail Value



Vehicle History Report™

US \$44.99

2000 TOYOTA TUNDRA SR5

VIN: 5TBBT4412YS121012
 4 DOOR EXTENDED CAB PICKUP
 4.7L V8 F DOHC 32V GASOLINE
 REAR WHEEL DRIVE W/ 4X4

Accident reported: minor damage

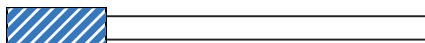

MINOR MODERATE SEVERE



13 Service history records



3 Previous owners



Personal vehicle



137,627 Last reported odometer reading



This CARFAX Vehicle History Report is based only on information supplied to CARFAX and available as of 8/6/24 at

8:08:27 PM (CDT). Other information about this vehicle, including problems, may not have been reported to CARFAX. Use this report as one important tool, along with a vehicle inspection and test drive, to make a better decision about your next used car.



Accident / Damage History

Not all accidents / issues are reported to CARFAX

Event 1

11/17/2002

**Accident reported:
very minor damage**

It hit an animal

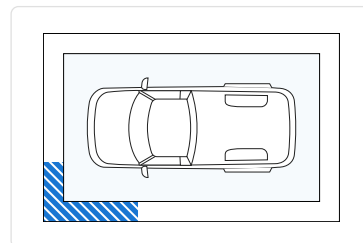
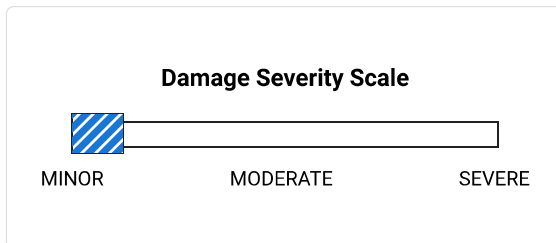

Event 2

09/16/2010

**Accident reported:
minor damage with
another motor vehicle**

Airbags did not deploy

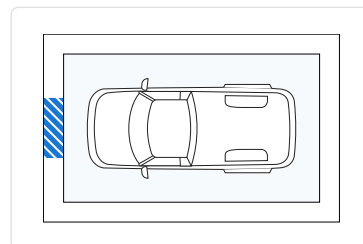
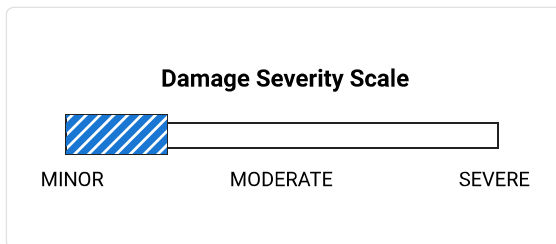

Additional History



Not all accidents / issues are reported to CARFAX

	Owner 1	Owner 2	Owner 3
Total Loss No total loss reported to CARFAX.	<input checked="" type="checkbox"/> No Issues Reported	<input checked="" type="checkbox"/> No Issues Reported	<input checked="" type="checkbox"/> No Issues Reported
Structural Damage CARFAX recommends that you have this vehicle inspected by a collision repair specialist.	<input checked="" type="checkbox"/> No Issues Reported	<input checked="" type="checkbox"/> No Issues Reported	<input checked="" type="checkbox"/> No Issues Reported
Airbag Deployment No airbag deployment reported to CARFAX.	<input checked="" type="checkbox"/> No Issues Reported	<input checked="" type="checkbox"/> No Issues Reported	<input checked="" type="checkbox"/> No Issues Reported
Odometer Check No indication of an odometer rollback.	<input checked="" type="checkbox"/> No Issues Indicated	<input checked="" type="checkbox"/> No Issues Indicated	<input checked="" type="checkbox"/> No Issues Indicated
Accident / Damage Accidents reported: 11/17/2002 and 09/16/2010.	Very Minor Damage	Minor Damage	No New Issues Reported

Manufacturer Recall No open recalls reported to CARFAX. Check with an authorized Toyota dealer for any open recalls. View Toyota disclosure	<input checked="" type="checkbox"/> No Recalls Reported	<input checked="" type="checkbox"/> No Recalls Reported	<input checked="" type="checkbox"/> No Recalls Reported
Basic Warranty Original warranty estimated to have expired.	Warranty Expired	Warranty Expired	Warranty Expired

 Title History	Owner 1	Owner 2	Owner 3
Damage Brands Salvage Junk Rebuilt Fire Flood Hail Lemon	No Problem	No Problem	No Problem
Odometer Brands Not Actual Mileage Exceeds Mechanical Limits	No Problem	No Problem	No Problem

 Ownership History The number of owners is estimated	Owner 1	Owner 2	Owner 3
Year purchased	2000	2010	2014
Type of owner	Personal	Personal	Personal
Estimated length of ownership	9 yrs. 7 mo.	3 yrs. 8 mo.	10 yrs. 4 mo.
Owned in the following states/provinces	Michigan	Michigan	Michigan
Estimated miles driven per year	4,370/yr	8,562/yr	---
Last reported odometer reading	28,020	69,763	137,627

 Detailed History			
 Owner 1 Purchased: 2000		Low mileage! This owner drove less than the industry average of 15,000 miles per year.	Personal Vehicle 4,370 mi/yr
Date	Mileage	Source	Comments
07/17/2000		NICB	Vehicle manufactured and shipped to original dealer

07/20/2000 6	Sunshine Toyota Springfield, MI 269-965-1000 sunshinetoyota.com	 Vehicle serviced Pre-delivery inspection completed
09/08/2000	Dealer Inventory	Vehicle sold
09/11/2000 31	Michigan Motor Vehicle Dept. Battle Creek, MI Title #216L2550308	Title issued or updated First owner reported Titled or registered as personal vehicle

11/17/2002

Damage Report





Accident reported: very minor damage
It hit an animal
Damage to left front



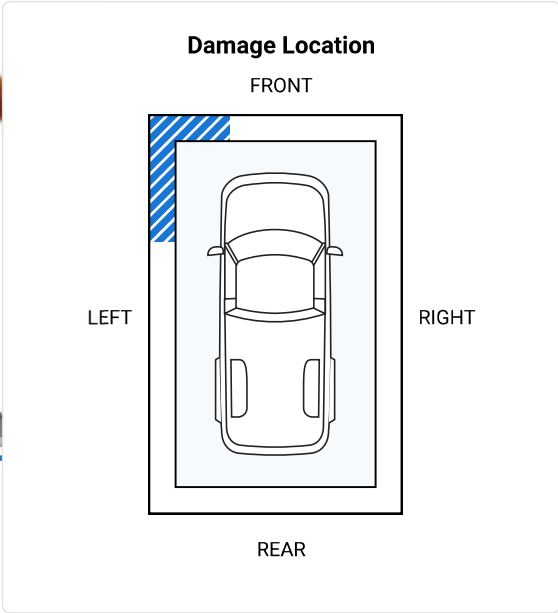

CARFAX HAS THE MOST ACCIDENT & DAMAGE INFORMATION



Minor damage is usually cosmetic, including dents or scratches to the vehicle body.

10/26/2005	18,651	Sunshine Toyota Springfield, MI 269-965-1000 sunshinetoyota.com ★ 4.6 / 5.0 601 Verified Reviews ♥ 7,353 Customer Favorites	 Vehicle serviced Tire(s) balanced Tires rotated Fluids checked Oil and filter changed
09/21/2006	23,695	Sunshine Toyota Springfield, MI 269-965-1000 sunshinetoyota.com ★ 4.6 / 5.0 601 Verified Reviews ♥ 7,353 Customer Favorites	 Vehicle serviced Maintenance inspection completed Oil and filter changed Engine/powertrain computer/module checked Fluids checked Maintenance reminder reset
02/07/2007	28,020	Sunshine Toyota Springfield, MI 269-965-1000 sunshinetoyota.com ★ 4.6 / 5.0 601 Verified Reviews ♥ 7,353 Customer Favorites	 Vehicle serviced Tire repaired
05/23/2007		Michigan Motor Vehicle Dept. Battle Creek, MI	Registration issued or renewed
04/29/2008		Michigan Motor Vehicle Dept. Battle Creek, MI	Registration issued or renewed
05/20/2009		Michigan Motor Vehicle Dept. Battle Creek, MI	Registration issued or renewed

 Owner 2 Purchased: 2010 	<div style="border: 1px solid #00aaff; padding: 5px;"> Low mileage! This owner drove less than the industry average of 15,000 miles per year. </div>	Personal Vehicle 8,562 mi/yr
---	---	---------------------------------

Date	Mileage	Source	Comments
04/30/2010		Michigan Motor Vehicle Dept. Ada, MI Title #263Y1200038	Title issued or updated New owner reported

09/16/2010

Damage Report



Accident reported: minor damage with another motor vehicle

Damage to front
Airbags did not deploy



CARFAX HAS THE MOST ACCIDENT & DAMAGE INFORMATION

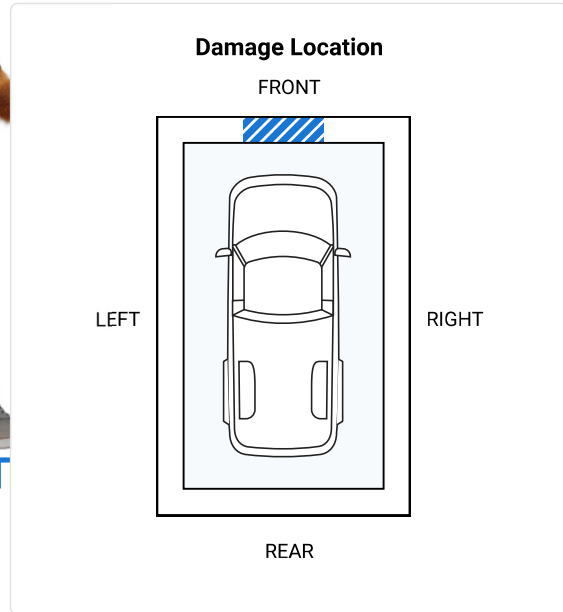
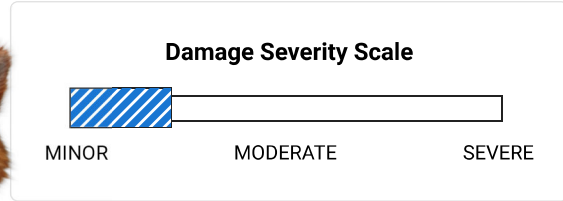

Minor damage is usually cosmetic, including dents or scratches to the vehicle body.

10/07/2010 41,724

Kool Toyota
Grand Rapids, MI
616-364-9700
kooltoyota.com



Vehicle serviced

Fuel filler cap replaced
Oil and filter changed
Tire condition and pressure checked

★ 4.6 / 5.0





152 Verified Reviews



♥ 103 Customer Favorites

06/03/2011

Michigan
Motor Vehicle Dept.
Ada, MI

Registration issued or renewed

07/28/2011	50,605	Kool Toyota Grand Rapids, MI 616-364-9700 kooltoyota.com ★ 4.6 / 5.0 152 Verified Reviews ❤️ 103 Customer Favorites		Vehicle serviced Front brake rotor(s) resurfaced Alignment performed Brakes checked PCV valve replaced Battery/charging system checked Two wheel alignment performed
09/12/2011	52,947	Kool Toyota Grand Rapids, MI 616-364-9700 kooltoyota.com ★ 4.6 / 5.0 152 Verified Reviews ❤️ 103 Customer Favorites		Vehicle serviced
05/11/2012		Michigan Motor Vehicle Dept. Ada, MI Title #263A1530440		Title issued or updated Registration issued or renewed
08/16/2012	63,416	Kool Toyota Grand Rapids, MI 616-364-9700 kooltoyota.com ★ 4.6 / 5.0 152 Verified Reviews ❤️ 103 Customer Favorites		Vehicle serviced Fuel injection system flushed/ serviced Transfer case fluid flushed/changed Differential serviced Transfer case serviced Electrical system checked Spark plugs cleaned and gap adjusted
06/04/2013		Michigan Motor Vehicle Dept. Ada, MI		Registration issued or renewed
12/19/2013	69,496	Kool Toyota Grand Rapids, MI 616-364-9700 kooltoyota.com ★ 4.6 / 5.0 152 Verified Reviews ❤️ 103 Customer Favorites		Vehicle serviced Fluids checked Oil and filter changed Maintenance reminder reset
01/14/2014	69,758	Fox Ford Mazda Grand Rapids, MI 616-956-5511 foxmazda.com/ ★ 4.5 / 5.0 262 Verified Reviews ❤️ 212 Customer Favorites		Vehicle offered for sale

<p>01/16/2014 69,762</p> <p>Fox Ford Mazda Grand Rapids, MI 616-956-5511 foxmazda.com/ ★ 4.5 / 5.0 262 Verified Reviews ❤️ 212 Customer Favorites</p>		<p>Vehicle serviced</p> <ul style="list-style-type: none"> Four tires balanced Four tires mounted Glass checked Muffler replaced Tailpipe replaced Vehicle washed/detailed A/C and heating system checked Tire(s) replaced Four tires replaced
		<p>Looks like this dealer serviced the car in order to prepare it for sale. That's a good thing!</p>

<p>01/30/2014 69,763</p> <p>Fox Ford Mazda Grand Rapids, MI 616-956-5511 foxmazda.com/ ★ 4.5 / 5.0 262 Verified Reviews ❤️ 212 Customer Favorites</p>	<p>Odometer reading reported</p>
---	---

<p>03/15/2014</p> <p>Fox Ford Mazda Grand Rapids, MI 616-956-5511 foxmazda.com/ ★ 4.5 / 5.0 262 Verified Reviews ❤️ 212 Customer Favorites</p>	<p>Vehicle sold</p>
--	----------------------------

	<p>Owner 3 Purchased: 2014</p>	<p>Personal Vehicle</p>
---	---	-------------------------

Date	Mileage	Source	Comments
03/18/2014		Michigan Motor Vehicle Dept. Middleville, MI Title #603C0772375	Title or registration issued New owner reported
03/31/2014		Fox Ford Mazda Grand Rapids, MI 616-956-5511 foxmazda.com/ ★ 4.5 / 5.0 262 Verified Reviews ❤️ 212 Customer Favorites	 <p>Vehicle serviced</p>

01/27/2015		Michigan Motor Vehicle Dept. Middleville, MI		Registration issued or renewed
01/28/2016		Michigan Motor Vehicle Dept. Middleville, MI		Registration issued or renewed
01/23/2017		Michigan Motor Vehicle Dept. Middleville, MI		Registration issued or renewed
01/31/2018		Michigan Motor Vehicle Dept. Middleville, MI		Registration issued or renewed
11/19/2018	121,592	Brians Auto Hastings Hastings, MI 269-945-9549 brianstireservice.net ★ 4.9 / 5.0 113 Verified Reviews ❤️ 450 Customer Favorites		Vehicle serviced Water pump replaced Timing belt replaced
01/30/2019		Michigan Motor Vehicle Dept. Middleville, MI		Registration issued or renewed
01/27/2020		Michigan Motor Vehicle Dept. Middleville, MI		Registration issued or renewed
06/30/2020	137,627	Brians Auto Hastings Hastings, MI 269-945-9549 brianstireservice.net ★ 4.9 / 5.0 113 Verified Reviews ❤️ 450 Customer Favorites		Vehicle serviced Brakes checked
01/27/2021		Michigan Motor Vehicle Dept. Middleville, MI		Registration issued or renewed
11/13/2023		Michigan Motor Vehicle Dept. Middleville, MI Title #MI0019205900		Title issued or updated Duplicate title issued Exempt from odometer reporting

Have Questions? Consumers, please visit our Help Center at www.carfax.com. Dealers or Subscribers, please visit our Help Center at www.carfaxonline.com.



Glossary

Accident Indicator

CARFAX receives information about accidents in all 50 states, the District of Columbia and Canada.

Not every accident is reported to CARFAX. As details about the accident become available, those additional details are added to the CARFAX Vehicle History Report. CARFAX recommends that you have this vehicle inspected by a qualified mechanic.

- According to the National Safety Council, Injury Facts, 2021 edition, 5% of the 276 million registered vehicles in the U.S. were involved in an accident in 2019. Over 77% of these were considered minor or moderate.
- This CARFAX Vehicle History Report is based only on information supplied to CARFAX and available as of 8/6/24 at 8:08:27 PM (CDT). Other information about this vehicle, including problems, may not have been reported to CARFAX. Use this report as one important tool, along with a vehicle inspection and test drive, to make a better decision about your next used car.

Damage Severity

Damage events result in one of the following severity levels:

- Minor: Generally, minor damage is cosmetic (including dents or scratches), may only require reconditioning, and typically does not compromise a vehicle's operation and/or safety.
- Moderate: Moderate damage may affect multiple components of the vehicle and may impair the vehicle's operation and/or safety.
- Severe: Severe damage usually affects multiple components of the vehicle and is likely to compromise the vehicle's operation and/or safety.

CARFAX recommends getting a pre-purchase inspection at a certified collision repair facility.

First Owner

When the first owner(s) obtains a title from a Department of Motor Vehicles as proof of ownership.

New Owner Reported

When a vehicle is sold to a new owner, the Title must be transferred to the new owner(s) at a Department of Motor Vehicles.

Ownership History

CARFAX defines an owner as an individual or business that possesses and uses a vehicle. Not all title transactions represent changes in ownership. To provide estimated number of owners, CARFAX proprietary technology analyzes all the events in a vehicle history. Estimated ownership is available for vehicles manufactured after 1991 and titled solely in the US including Puerto Rico. Dealers sometimes opt to take ownership of a vehicle and are required to in the following states: Maine, Massachusetts, New Jersey, Ohio, Oklahoma, Pennsylvania and South Dakota. Please consider this as you review a vehicle's estimated ownership history.

Title Issued

A state issues a title to provide a vehicle owner with proof of ownership. Each title has a unique number. Each title or registration record on a CARFAX report does not necessarily indicate a change in ownership. In Canada, a registration and bill of sale are used as proof of ownership.

Toyota Recall / Service Campaign

Portions of this report have been included under license from Toyota Motor North America, Inc. ("TOYOTA"), License Agreement TMS1013 . This data applies only to vehicle marketed or originally sold in Mexico and the United States of America, including Guam, Saipan, American Samoa, Puerto Rico, the U.S. Virgin Islands and the other United States territories and protectorates with currently open safety or emissions recalls, or service campaigns. While TOYOTA provides data to Carfax Inc. on a regular basis, this report may not include very recent activity. For the manufacturer's most current information on recall/campaign activity for any Toyota, Lexus or Scion brand vehicle, you must go to <http://toyota.com/recall> or <http://lexus.com/recall>.

Follow Us:



[facebook.com/CARFAX](https://www.facebook.com/CARFAX)



[@CARFAXinc](https://twitter.com/CARFAXinc)



About CARFAX

CARFAX DEPENDS ON ITS SOURCES FOR THE ACCURACY AND RELIABILITY OF ITS INFORMATION. THEREFORE, NO RESPONSIBILITY IS ASSUMED BY CARFAX OR ITS AGENTS FOR ERRORS OR OMISSIONS IN THIS REPORT. CARFAX FURTHER EXPRESSLY DISCLAIMS ALL WARRANTIES, EXPRESS OR IMPLIED, INCLUDING ANY IMPLIED WARRANTIES OF MERCHANTABILITY OR FITNESS FOR A PARTICULAR PURPOSE.

© 2024 CARFAX, Inc., part of S&P Global. All rights reserved.
8/6/24 8:08:27 PM (CDT)

I have reviewed and received a copy of the CARFAX Vehicle History Report for this 2000 TOYOTA TUNDRA vehicle (VIN: 5TBBT4412YS121012), which is based on information supplied to CARFAX and available as of 8/6/24 at 9:08 PM (EDT).

Customer Signature

Date

Dealer Signature

Date