



### History-Based Value Report

# \$7,890

CARFAX Retail Value

#### History events affecting this vehicle's value

- Service History
- Personal Vehicle
- Open Recall
- Minor Damage



### Vehicle History Report™

US \$44.99

#### 2011 KIA SOUL +

VIN: KNDJT2A27B7295809  
 4 DOOR WAGON/SPORT  
 UTILITY  
 2.0L I4 F DOHC 16V  
 GASOLINE  
 FRONT WHEEL DRIVE

#### Accident reported: minor damage

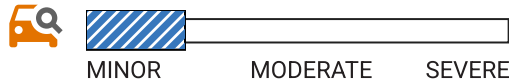

**23** Service history records

At least 1 open recall

**3** Previous owners

**66,370** Last reported odometer reading



This CARFAX Vehicle History Report is based only on information supplied to CARFAX and available as of 8/29/25 at 9:09:15 AM (CDT). Other information about this vehicle, including problems, may not have been reported to CARFAX. Use this report as one important tool, along with a vehicle inspection and test drive, to make a better decision about your next used car.



### Accident / Damage History

Not all accidents / issues are reported to CARFAX

#### Event 1

09/07/2017

**Damage reported: minor damage**

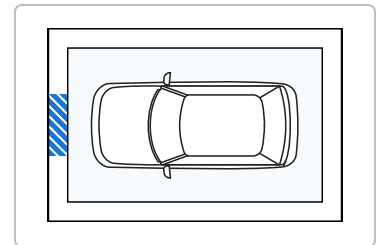
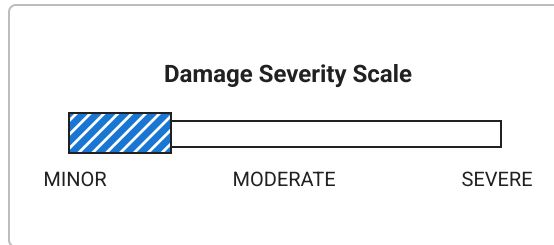

#### Event 2

05/23/2024

**Accident reported: minor damage**

- Vehicle ran off road
- It hit a ditch
- Functional damage reported

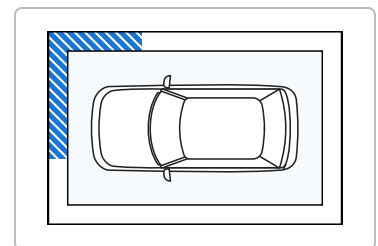
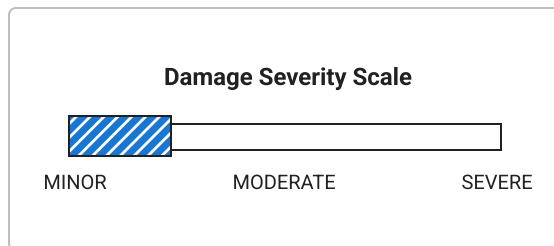

### Additional History

Not all accidents / issues are reported to CARFAX

	Owner 1	Owner 2	Owner 3
<b>Total Loss</b> No total loss reported to CARFAX.	<input checked="" type="checkbox"/> No Issues Reported	<input checked="" type="checkbox"/> No Issues Reported	<input checked="" type="checkbox"/> No Issues Reported
<b>Structural Damage</b> CARFAX recommends that you have this vehicle inspected by a collision repair specialist.	<input checked="" type="checkbox"/> No Issues Reported	<input checked="" type="checkbox"/> No Issues Reported	<input checked="" type="checkbox"/> No Issues Reported
<b>Airbag Deployment</b> No airbag deployment reported to CARFAX.	<input checked="" type="checkbox"/> No Issues Reported	<input checked="" type="checkbox"/> No Issues Reported	<input checked="" type="checkbox"/> No Issues Reported
<b>Odometer Check</b> No indication of an odometer rollback.	<input checked="" type="checkbox"/> No Issues Indicated	<input checked="" type="checkbox"/> No Issues Indicated	<input checked="" type="checkbox"/> No Issues Indicated
<b>Accident / Damage</b> Damage reported: 09/07/2017. Accident reported: 05/23/2024.	Minor Damage	No New Issues Reported	Minor Damage



<b>Manufacturer Recall</b> At least 1 open recall reported.	<input checked="" type="checkbox"/> No Recalls Reported	<input checked="" type="checkbox"/> No Recalls Reported	Recall Reported
<b>Basic Warranty</b> Original warranty estimated to have expired.	<b>Warranty Expired</b>	<b>Warranty Expired</b>	<b>Warranty Expired</b>

<b>CARFAX Title History</b> CARFAX guarantees the information in this section	<b>Owner 1</b>	<b>Owner 2</b>	<b>Owner 3</b>
<b>Damage Brands</b> Salvage   Junk   Rebuilt   Fire   Flood   Hail   Lemon	<input checked="" type="checkbox"/> <b>Guaranteed</b> No Problem	<input checked="" type="checkbox"/> <b>Guaranteed</b> No Problem	<input checked="" type="checkbox"/> <b>Guaranteed</b> No Problem
<b>Odometer Brands</b> Not Actual Mileage   Exceeds Mechanical Limits	<input checked="" type="checkbox"/> <b>Guaranteed</b> No Problem	<input checked="" type="checkbox"/> <b>Guaranteed</b> No Problem	<input checked="" type="checkbox"/> <b>Guaranteed</b> No Problem



**GUARANTEED** - None of these title problems were reported by a U.S. state Department of Motor Vehicles (DMV). If you find that any of these title problems were reported by a DMV and not included in this report, you may qualify.  
View Terms | View Certificate

<b>CARFAX Ownership History</b> The number of owners is estimated	<b>Owner 1</b>	<b>Owner 2</b>	<b>Owner 3</b>
Year purchased	2011	2021	2022
Type of owner	Personal	Personal	Personal
Estimated length of ownership	10 yrs. 2 mo.	6 months	3 yrs. 4 mo.
Owned in the following states/provinces	Arizona	Michigan	Michigan
Estimated miles driven per year	5,789/yr	---	1,871/yr
Last reported odometer reading	58,561	63,354	66,370

<b>CARFAX Detailed History</b>				
 <b>Owner 1</b> Purchased: 2011			<div style="border: 1px solid blue; padding: 5px;"> <b>Low mileage!</b> This owner drove less than the industry average of 15,000 miles per year.                 </div>	Personal Vehicle 5,789 mi/yr
Date	Mileage	Source	Comments	
07/22/2011	33	Arizona Motor Vehicle Dept. Chandler, AZ	<b>Registration issued or renewed</b> - First owner reported - Titled or registered as personal vehicle	

Title #0D07011201010

- Loan or lien reported

10/09/2012 8,997

Fort Collins Nissan  
Fort Collins, CO  
970-282-1400  
fortcollinsnissan.com**Vehicle serviced**- Maintenance inspection completed  
- Oil and filter changed  
- Tires rotated

★ 4.6 / 5.0

562 Verified Reviews

❤️ 1,469 Customer Favorites

02/08/2013 9,975

Fort Collins Nissan  
Fort Collins, CO  
970-282-1400  
fortcollinsnissan.com**Vehicle serviced**

★ 4.6 / 5.0

562 Verified Reviews

❤️ 1,469 Customer Favorites

05/01/2013 11,181

Fort Collins Nissan  
Fort Collins, CO  
970-282-1400  
fortcollinsnissan.com**Vehicle serviced**

★ 4.6 / 5.0

562 Verified Reviews

❤️ 1,469 Customer Favorites

01/24/2014 15,654

Fort Collins Nissan  
Fort Collins, CO  
970-282-1400  
fortcollinsnissan.com**Vehicle serviced**- Maintenance inspection completed  
- 15,000 mile service performed

★ 4.6 / 5.0

562 Verified Reviews

❤️ 1,469 Customer Favorites

02/17/2014 15,729

Fort Collins Nissan  
Fort Collins, CO  
970-282-1400  
fortcollinsnissan.com**Vehicle serviced**- Maintenance inspection completed  
- Battery replaced  
- Electrical system checked

★ 4.6 / 5.0

562 Verified Reviews

❤️ 1,469 Customer Favorites

06/17/2014 16,455

Fort Collins Nissan  
Fort Collins, CO  
970-282-1400  
fortcollinsnissan.com**Vehicle serviced**- Maintenance inspection completed  
- Electrical system checked

★ 4.6 / 5.0

562 Verified Reviews

 **1,469** Customer Favorites

01/08/2015 18,349

Fort Collins Nissan  
Fort Collins, CO  
970-282-1400  
fortcollinsnissan.com



**Vehicle serviced**

- Maintenance inspection completed
- Oil and filter changed

 **4.6 / 5.0**

562 Verified Reviews

 **1,469** Customer Favorites

07/09/2015 19,872

Fort Collins Nissan  
Fort Collins, CO  
970-282-1400  
fortcollinsnissan.com



**Vehicle serviced**

- Oil and filter changed

 **4.6 / 5.0**

562 Verified Reviews

 **1,469** Customer Favorites

04/19/2016 21,366

Fort Collins Nissan  
Fort Collins, CO  
970-282-1400  
fortcollinsnissan.com



**Vehicle serviced**

- Maintenance inspection completed
- Oil and filter changed
- Wiper(s) replaced

 **4.6 / 5.0**

562 Verified Reviews

 **1,469** Customer Favorites

06/18/2016 23,000

Arizona  
Inspection Station  
Maricopa County

**Passed emissions inspection**

08/02/2016 25,308

Horne Kia  
Gilbert, AZ  
480-813-3300  
<https://hornekia.com/>



**Vehicle serviced**

- Maintenance inspection completed
- Air filter replaced
- Cabin air filter replaced/cleaned
- Oil and filter changed
- Tires rotated

 **4.5 / 5.0**

1,140 Verified Reviews

 **15,245** Customer Favorites

09/03/2016

Arizona  
Motor Vehicle Dept.  
Title #ELTB016247652

**Title issued or updated**

04/14/2017 31,747

Horne Kia  
Gilbert, AZ  
480-813-3300  
<https://hornekia.com/>



**Vehicle serviced**

- Maintenance inspection completed
- Front wiper blades/refills replaced
- Transmission fluid changed
- Transmission fluid flushed

 **4.5 / 5.0**

1,140 Verified Reviews

 **15,245** Customer Favorites

09/07/2017

Damage Report



Damage reported: minor damage

- Damage to front



CARFAX HAS THE MOST ACCIDENT & DAMAGE INFORMATION

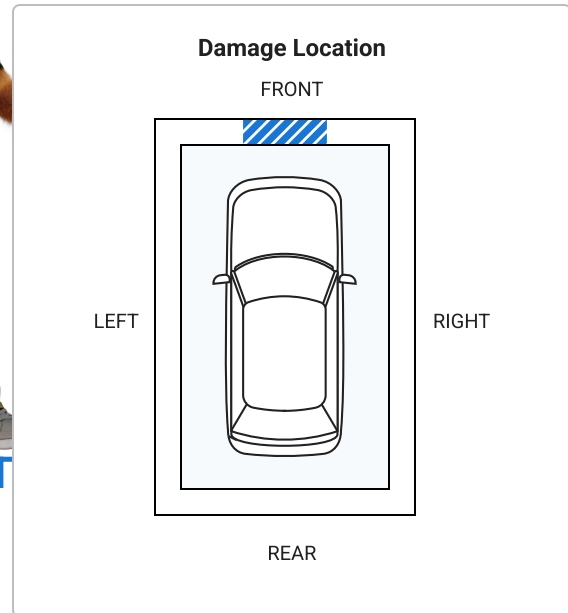
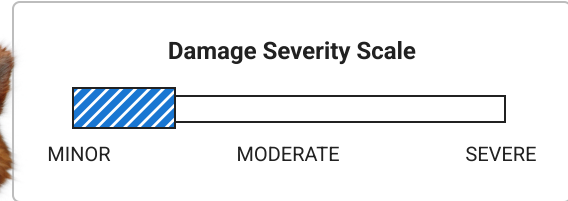

Minor damage is usually cosmetic, including dents or scratches to the vehicle body.

10/20/2017 35,389

Horne Kia  
Gilbert, AZ  
480-813-3300  
<https://hornekia.com/>

★ 4.5 / 5.0  
1,140 Verified Reviews  
♥ 15,245 Customer Favorites



Vehicle serviced

- Maintenance inspection completed
- Oil and filter changed
- Tires rotated

04/20/2018 38,816

Horne Kia  
Gilbert, AZ  
480-813-3300  
<https://hornekia.com/>

★ 4.5 / 5.0  
1,140 Verified Reviews  
♥ 15,245 Customer Favorites







Vehicle serviced



- Maintenance inspection completed
- Antifreeze/coolant flushed/changed
- Oil and filter changed
- Tires rotated

07/10/2018 40,000



Arizona  
Inspection Station  
Maricopa County

Passed emissions inspection

10/19/2018	42,566	Horne Kia Gilbert, AZ 480-813-3300 <a href="https://hornekia.com/">https://hornekia.com/</a> ★ 4.5 / 5.0 1,140 Verified Reviews ♥ 15,245 Customer Favorites	 <b>Vehicle serviced</b> - Induction system serviced - Oil and filter changed - Tires rotated
04/01/2019	46,454	Horne Kia Gilbert, AZ 480-813-3300 <a href="https://hornekia.com/">https://hornekia.com/</a> ★ 4.5 / 5.0 1,140 Verified Reviews ♥ 15,245 Customer Favorites	 <b>Vehicle serviced</b> - Two wheel alignment performed
10/04/2019	50,518	Horne Kia Gilbert, AZ 480-813-3300 <a href="https://hornekia.com/">https://hornekia.com/</a> ★ 4.5 / 5.0 1,140 Verified Reviews ♥ 15,245 Customer Favorites	 <b>Vehicle serviced</b> - Maintenance inspection completed - Oil and filter changed - Tires rotated
07/06/2020	53,751	Arizona Inspection Station Maricopa County	<b>Passed emissions inspection</b>
07/06/2020		Arizona Motor Vehicle Dept. Chandler, AZ Title #ELTB016247652	<b>Registration issued or renewed</b>
10/12/2020	54,815	Horne Kia Gilbert, AZ 480-813-3300 <a href="https://hornekia.com/">https://hornekia.com/</a> ★ 4.5 / 5.0 1,140 Verified Reviews ♥ 15,245 Customer Favorites	 <b>Vehicle serviced</b> - Brakes checked - Fluids checked - Oil and filter changed - Tire condition and pressure checked - Tires rotated
10/30/2020	55,136	Horne Kia Gilbert, AZ 480-813-3300 <a href="https://hornekia.com/">https://hornekia.com/</a> ★ 4.5 / 5.0 1,140 Verified Reviews ♥ 15,245 Customer Favorites	 <b>Vehicle serviced</b> - Air filter replaced - Alignment performed - Four tires balanced - Four tires mounted - Tire(s) replaced - Transmission fluid changed

04/26/2021	57,159	Horne Kia Gilbert, AZ 480-813-3300 <a href="https://hornekia.com/">https://hornekia.com/</a> ★ 4.5 / 5.0 1,140 Verified Reviews ♥ 15,245 Customer Favorites	 <b>Vehicle serviced</b> - Antifreeze/coolant flushed/changed - Serpentine belt replaced - Timing belt replaced
08/30/2021	58,561	Horne Kia Gilbert, AZ 480-813-3300 <a href="https://hornekia.com/">https://hornekia.com/</a> ★ 4.5 / 5.0 1,140 Verified Reviews ♥ 15,245 Customer Favorites	 <b>Vehicle serviced</b> - Brake fluid flushed/changed - Oil and filter changed - Power steering fluid flushed/changed - Tires rotated

 **Owner 2** Personal Vehicle  
Purchased: 2021

Date	Mileage	Source	Comments
10/07/2021		Michigan Motor Vehicle Dept. Saginaw, MI Title #MI0011152371	<b>Vehicle purchase reported</b> - Title issued or updated - Registration issued or renewed - New owner reported
04/06/2022		Serra Saginaw Automotive Saginaw, MI 877-438-1166 <a href="http://serrasaginaw.com">serrasaginaw.com</a> ★ 4.6 / 5.0 959 Verified Reviews ♥ 11,680 Customer Favorites	 <b>Vehicle serviced</b> - Pre-delivery inspection completed - Brakes checked - Oil and filter changed
04/08/2022		Serra Saginaw Automotive Saginaw, MI 877-438-1166 <a href="http://serrasaginaw.com/">serrasaginaw.com/</a> ★ 4.6 / 5.0 959 Verified Reviews ♥ 11,680 Customer Favorites	<b>Vehicle sold</b>
04/08/2022	63,354	Serra Saginaw Automotive Saginaw, MI 877-438-1166 <a href="http://serrasaginaw.com">serrasaginaw.com</a>	 <b>Vehicle serviced</b> - Vehicle washed/detailed

★ **4.6 / 5.0**  
 959 Verified Reviews  
 ❤️ **11,680** Customer Favorites



04/08/2022	Michigan Motor Vehicle Dept. Pinconning, MI	<b>Vehicle purchase reported</b> - Registration issued or renewed - Loan or lien reported
------------	---	---

 **Owner 3**  
Purchased: 2022



**Low mileage!** This owner drove less than the industry average of 15,000 miles per year.

Personal Vehicle  
1,871 mi/yr

Date	Mileage	Source	Comments
04/08/2022	63,888	Michigan Motor Vehicle Dept. Pinconning, MI Title #MI0012997485	<b>Title issued or updated</b> - New owner reported
07/29/2023		Michigan Motor Vehicle Dept. Pinconning, MI	<b>Registration issued or renewed</b>
08/05/2023	66,370	Fast Eddie's Saginaw, MI 989-792-5755 fasteddiescarcare.com/ ★ <b>4.8 / 5.0</b> 16 Verified Reviews	 <b>Vehicle serviced</b> - Oil and filter changed
09/25/2023		Kia Motors America, Inc.	<b>Manufacturer Safety Recall issued</b> - NHTSA #23V652 - Recall #SC284AM HECU FUSE - Status: Remedy Available  Locate an authorized Kia dealer near you to schedule an appointment   <b>Learn more about this recall</b>

**Description:** KIA AMERICA, INC. IS RECALLING CERTAIN 2011-2013 SOUL VEHICLES. THE HYDRAULIC ELECTRONIC CONTROL UNIT (HECU) MAY EXPERIENCE AN ELECTRICAL SHORT, WHICH CAN RESULT IN AN ENGINE COMPARTMENT FIRE WHILE PARKED OR DRIVING.

AN ENGINE COMPARTMENT FIRE WHILE PARKED OR DRIVING CAN INCREASE THE RISK OF INJURY.

**Remedy:** OWNERS ARE ADVISED TO PARK OUTSIDE AND AWAY FROM STRUCTURES UNTIL THE RECALL REPAIR IS COMPLETE. DEALERS WILL REPLACE THE HECU FUSE, FREE OF CHARGE. INTERIM NOTIFICATION LETTERS, NOTIFYING OWNERS OF THE SAFETY RISK, WERE MAILED NOVEMBER 14, 2023. OWNER NOTIFICATION LETTERS WERE MAILED

MARCH 29, 2024 THROUGH JUNE 18,2024. OWNERS MAY CONTACT KIA CUSTOMER SERVICE AT 1-800-333-4542. KIA'S NUMBER FOR THIS RECALL IS SC284.

12/12/2023

Kia Motors America, Inc.

**Manufacturer Customer Satisfaction Campaign issued**

- Campaign #CS2311A CS2311A ANTI-THEFT IGNITION PROTECTOR
- Status: Remedy Available

Locate an authorized Kia dealer near you to schedule an appointment

05/23/2024

Damage Report



**Accident reported: minor damage**

- Vehicle ran off road
- It hit a ditch
- Damage to right front
- Damage to front
- Functional damage reported



**CARFAX HAS THE MOST ACCIDENT & DAMAGE INFORMATION**

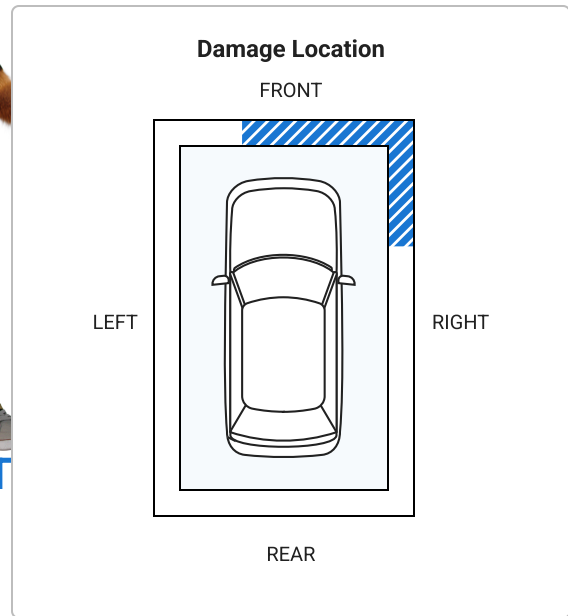
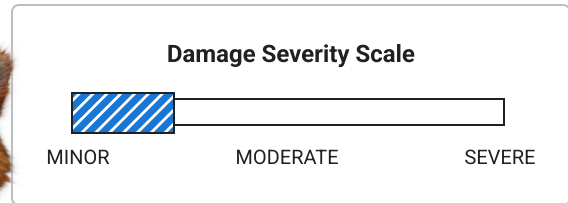

Minor damage is usually cosmetic, including dents or scratches to the vehicle body.

Have Questions? Consumers, please visit our Help Center at [www.carfax.com](http://www.carfax.com). Dealers or Subscribers, please visit our Help Center at [www.carfaxonline.com](http://www.carfaxonline.com).



Glossary

**Accident Indicator**

CARFAX receives information about accidents in all 50 states, the District of Columbia and Canada.

Not every accident is reported to CARFAX. As details about the accident become available, those additional details are added to the CARFAX Vehicle History Report. CARFAX recommends that you have this vehicle inspected by a qualified mechanic.

- According to the National Safety Council, Injury Facts, 2021 edition, 5% of the 276 million registered vehicles in the U.S. were involved in an accident in 2019. Over 77% of these were considered minor or moderate.
- This CARFAX Vehicle History Report is based only on information supplied to CARFAX and available as of 8/29/25 at 9:09:15 AM (CDT). Other information about this vehicle, including problems, may not have been reported to CARFAX. Use this report as one important tool, along with a vehicle inspection and test drive, to make a better decision about your next used car.

**Damage Indicator**

Damage can be a result of many different types of events. Examples include contact with objects (other cars, trees, traffic signs, road debris, etc), vandalism, or weather-related events. Not every damage event is reported to CARFAX. As details about the damage event become available, those additional details are added to the CARFAX Vehicle History Report. CARFAX recommends that you have this vehicle inspected by a qualified mechanic.

- This CARFAX Vehicle History Report is based only on information supplied to CARFAX and available as of 8/29/25 at 9:09:15 AM (CDT). Other information about this vehicle, including problems, may not have been reported to CARFAX. Use this report as one important tool, along with a vehicle inspection and test drive, to make a better decision about your next used car.

**Damage Severity**

Damage events result in one of the following severity levels:

- Minor: Generally, minor damage is cosmetic (including dents or scratches), may only require reconditioning, and typically does not compromise a vehicle's operation and/or safety.
- Moderate: Moderate damage may affect multiple components of the vehicle and may impair the vehicle's operation and/or safety.
- Severe: Severe damage usually affects multiple components of the vehicle and is likely to compromise the vehicle's operation and/or safety.

CARFAX recommends getting a pre-purchase inspection at a certified collision repair facility.

**First Owner**

When the first owner(s) obtains a title from a Department of Motor Vehicles as proof of ownership.

**Manufacturer Recall**

Automobile manufacturers issue recall notices to inform vehicle owners of a safety defect or failure to meet minimum federal safety or emissions standards. Manufacturer recalls are repaired at no cost to the customer.

**New Owner Reported**

When a vehicle is sold to a new owner, the Title must be transferred to the new owner(s) at a Department of Motor Vehicles.

**Ownership History**



CARFAX defines an owner as an individual or business that possesses and uses a vehicle. Not all title transactions represent changes in ownership. To provide estimated number of owners, CARFAX proprietary technology analyzes all the events in a vehicle history. Estimated ownership is available for vehicles manufactured after 1991 and titled solely in the US including Puerto Rico. Dealers sometimes opt to take ownership of a vehicle and are required to in the following states: Maine, Massachusetts, New Jersey, Ohio, Oklahoma, Pennsylvania and South Dakota. Please consider this as you review a vehicle's estimated ownership history.

**Service Campaign**

Automobile manufacturers issue a service campaign to address product technical issues that may not be related to safety or emissions standards. These issues are typically customer satisfaction initiatives.

**Title Issued**

A state issues a title to provide a vehicle owner with proof of ownership. Each title has a unique number. Each title or registration record on a CARFAX report does not necessarily indicate a change in ownership. In Canada, a registration and bill of sale are used as proof of ownership.

**Follow Us:**  [facebook.com/CARFAX](https://facebook.com/CARFAX)  [@CARFAXinc](https://twitter.com/CARFAXinc)  [About CARFAX](#)

CARFAX DEPENDS ON ITS SOURCES FOR THE ACCURACY AND RELIABILITY OF ITS INFORMATION. THEREFORE, NO RESPONSIBILITY IS ASSUMED BY CARFAX OR ITS AGENTS FOR ERRORS OR OMISSIONS IN THIS REPORT. CARFAX FURTHER EXPRESSLY DISCLAIMS ALL WARRANTIES, EXPRESS OR IMPLIED, INCLUDING ANY IMPLIED WARRANTIES OF MERCHANTABILITY OR FITNESS FOR A PARTICULAR PURPOSE.

© 2025 CARFAX, Inc., part of S&P Global. All rights reserved.  
8/29/25 9:09:15 AM (CDT)

**I have reviewed and received a copy of the CARFAX Vehicle History Report for this 2011 KIA SOUL vehicle (VIN: KNDJT2A27B7295809), which is based on information supplied to CARFAX and available as of 8/29/25 at 10:09 AM (EDT).**

\_\_\_\_\_

**Customer Signature**

\_\_\_\_\_

**Date**

\_\_\_\_\_

**Dealer Signature**

\_\_\_\_\_

**Date**