

Display CARFAX in online listings:

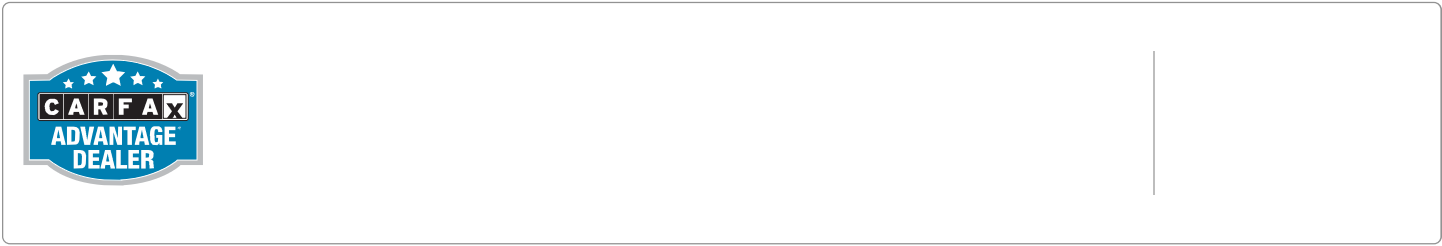

CARFAX History-Based Value Report

History events affecting this vehicle's value

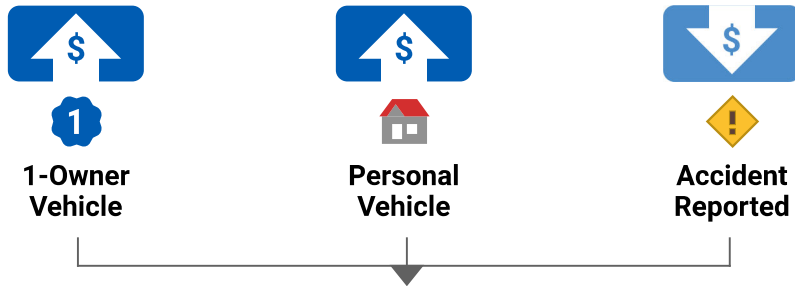

\$9,740 Retail Value



Vehicle History Report™

US \$44.99

2010 SUBARU FORESTER 2.5X LIMITED

VIN: JF2SH6DC0AH749393
 4 DOOR WAGON/SPORT UTILITY
 2.5L H4 F SOHC 16V GASOLINE
 ALL WHEEL DRIVE

Accident reported: moderate damage



10 Service history records



1 CARFAX 1-Owner vehicle

Personal vehicle

102,077 Last reported odometer reading

This CARFAX Vehicle History Report is based only on information supplied to CARFAX and available as of 5/12/23 at 3:31:59 PM (CDT). Other information about this vehicle, including problems, may not have been reported to CARFAX. Use this report as one important tool, along with a vehicle inspection and test drive, to make a better decision about your next used car.

 Ownership History The number of owners is estimated		Owner 1
Year purchased		2010
Type of owner		Personal
Estimated length of ownership		13 yrs. 3 mo.
Owned in the following states/provinces		Virginia
Estimated miles driven per year		10,149/yr
Last reported odometer reading		102,077

 Title History CARFAX guarantees the information in this section		Owner 1
Damage Brands Salvage Junk Rebuilt Fire Flood Hail Lemon		<input checked="" type="checkbox"/> Guaranteed No Problem
Odometer Brands Not Actual Mileage Exceeds Mechanical Limits		<input checked="" type="checkbox"/> Guaranteed No Problem
 GUARANTEED - None of these major title problems were reported by a state Department of Motor Vehicles (DMV). If you find that any of these title problems were reported by a DMV and not included in this report, CARFAX will buy this vehicle back. View Terms View Certificate		

 Additional History Not all accidents / issues are reported to CARFAX		Owner 1
Total Loss No total loss reported to CARFAX.		<input checked="" type="checkbox"/> No Issues Reported
Structural Damage CARFAX recommends that you have this vehicle inspected by a collision repair specialist.		<input checked="" type="checkbox"/> No Issues Reported
Airbag Deployment No airbag deployment reported to CARFAX.		<input checked="" type="checkbox"/> No Issues Reported
Odometer Check No indication of an odometer rollback.		<input checked="" type="checkbox"/> No Issues Indicated
Accident / Damage Damage reported: 12/24/2013. Accidents reported: 04/02/2015 and 05/04/2017.		Accident Reported

Manufacturer Recall	<input checked="" type="checkbox"/> No Recalls Reported
Check with an authorized Subaru dealer for any open recalls.	
Basic Warranty	Warranty Expired
Original warranty estimated to have expired.	







Detailed History



Owner 1
Purchased: 2010

Personal Vehicle
10,149 mi/yr

Date	Mileage	Source	Comments
01/28/2010	2	Stohlman VW Subaru Vienna, VA 703-893-2990 stohlmanauto.com ★ 4.7 / 5.0 1,368 Verified Reviews ❤️ 16,835 Customer Favorites	 Vehicle serviced Pre-delivery inspection completed Emissions or safety inspection performed
01/28/2010	8	Stohlman VW Subaru Vienna, VA 703-893-2990 stohlmanauto.com ★ 4.7 / 5.0 1,368 Verified Reviews ❤️ 16,835 Customer Favorites	Vehicle offered for sale
02/01/2010		Stohlman VW Subaru Vienna, VA 703-893-2990 stohlmanauto.com ★ 4.7 / 5.0 1,368 Verified Reviews ❤️ 16,835 Customer Favorites	Vehicle sold
02/01/2010		Virginia Motor Vehicle Dept.	Vehicle purchase reported
02/11/2010		Virginia Motor Vehicle Dept. Alexandria, VA	Title issued or updated Title or registration issued First owner reported Titled or registered as personal vehicle

08/03/2010 7,373	Stohlman VW Subaru Vienna, VA 703-893-2990 stohlmanauto.com ★ 4.7 / 5.0 1,368 Verified Reviews ❤️ 16,835 Customer Favorites		Vehicle serviced 7,500 mile service performed Fluids checked Oil and filter changed Tire condition and pressure checked Tires rotated Tire repaired Body electrical system checked
01/06/2011	Virginia Motor Vehicle Dept. Alexandria, VA	Registration issued or renewed Loan or lien reported	
01/31/2011 14,241	Stohlman VW Subaru Vienna, VA 703-893-2990 stohlmanauto.com ★ 4.7 / 5.0 1,368 Verified Reviews ❤️ 16,835 Customer Favorites		Vehicle serviced Recommended maintenance performed Oil and filter changed Tire condition and pressure checked Cabin air filter replaced/cleaned Drivability/performance checked Exterior lights checked
10/21/2011 27,138	Don Beyer Volvo of Alexandria Alexandria, VA 703-768-5800 donbeyervolvo.com ★ 4.7 / 5.0 1,031 Verified Reviews ❤️ 9,294 Customer Favorites		Vehicle serviced Maintenance inspection completed Oil and filter changed Tire condition and pressure checked Exterior trim checked
01/11/2012 30,167	Virginia Inspection Station Alexandria, VA	Passed emissions inspection	
02/27/2012	Virginia Motor Vehicle Dept. Alexandria, VA	Registration issued or renewed Loan or lien reported	
05/29/2012 35,517	Don Beyer Volvo of Alexandria Alexandria, VA 703-768-5800 donbeyervolvo.com ★ 4.7 / 5.0 1,031 Verified Reviews ❤️ 9,294 Customer Favorites		Vehicle serviced Exterior trim checked

10/09/2012	38,090	Don Beyer Volvo of Alexandria Alexandria, VA 703-768-5800 donbeyervolvo.com	 Vehicle serviced Exterior trim checked
		★ 4.7 / 5.0 1,031 Verified Reviews ❤️ 9,294 Customer Favorites	

01/28/2013	40,515	Virginia Inspection Station	Passed safety inspection
------------	--------	-----------------------------	---------------------------------



05/13/2013	43,175	Don Beyer Volvo of Alexandria Alexandria, VA 703-768-5800 donbeyervolvo.com	 Vehicle serviced Maintenance inspection completed Vehicle washed/detailed
		★ 4.7 / 5.0 1,031 Verified Reviews ❤️ 9,294 Customer Favorites	

12/24/2013	Damage Report	 Damage reported: minor damage Damage to right front Damage to front
------------	---------------	--

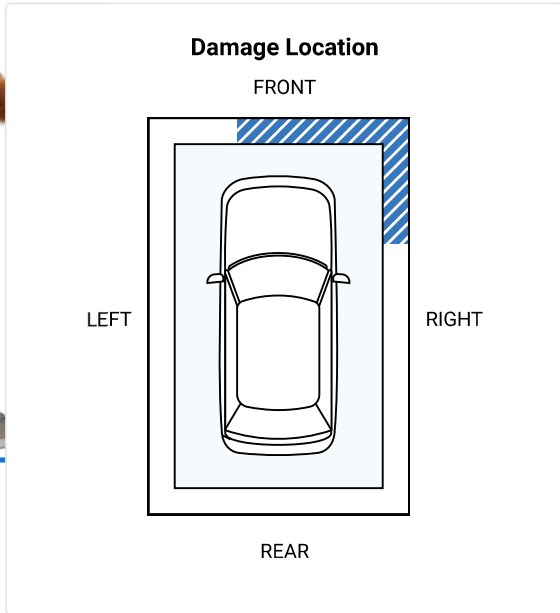
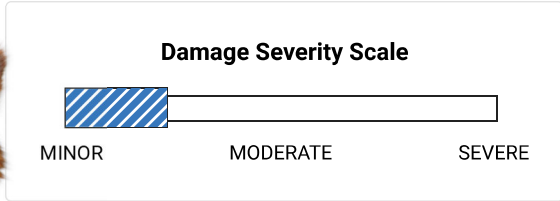

CARFAX HAS THE MOST ACCIDENT & DAMAGE INFORMATION





01/29/2014	50,000	Virginia Inspection Station Alexandria, VA	Passed safety inspection Passed emissions inspection
03/29/2014	51,000	Virginia Inspection Station Alexandria, VA	Passed emissions inspection
03/29/2014		Virginia Motor Vehicle Dept. Alexandria, VA	Registration issued or renewed
08/11/2014	56,254	Don Beyer Volvo of Alexandria Alexandria, VA 703-768-5800 donbeyervolvo.com ★ 4.7 / 5.0 1,031 Verified Reviews ♥ 9,294 Customer Favorites	 Vehicle serviced Trim checked Accessories installed
01/29/2015	60,437	Virginia Inspection Station	Passed safety inspection
04/02/2015		Damage Report	 Accident reported: moderate damage with another motor vehicle Damage to front Damage to left front Damage to right front Vehicle towed Airbags did not deploy

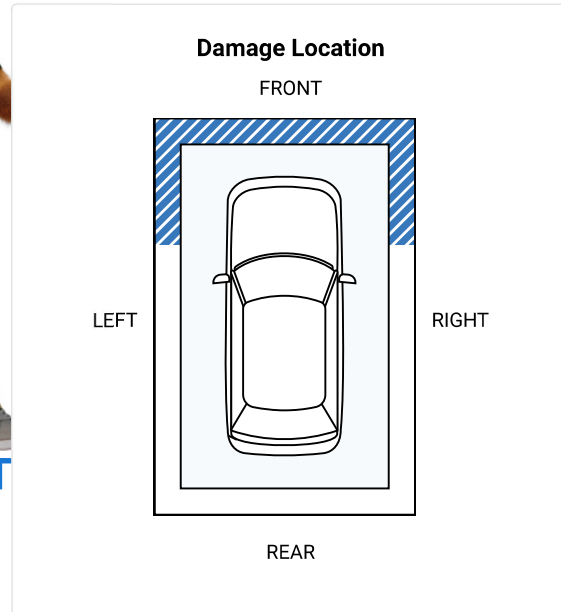
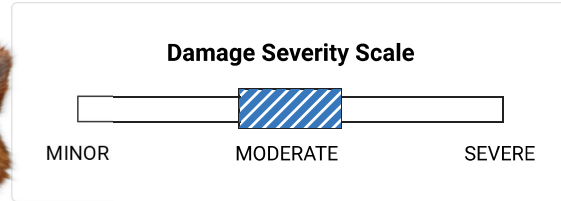

CARFAX HAS THE MOST ACCIDENT & DAMAGE INFORMATION



07/20/2015	62,553	Don Beyer Volvo of Alexandria, VA 703-768-5800 donbeyervolvo.com	 Vehicle serviced Sway bar link(s) replaced Engine/powertrain computer/module checked Sway bar bushing(s) replaced Drive belt(s) replaced
		 4.7 / 5.0 1,031 Verified Reviews  9,294 Customer Favorites	Passed safety inspection Passed emissions inspection
01/07/2016	66,000	Virginia Inspection Station Alexandria, VA	Registration issued or renewed
01/08/2016		Virginia Motor Vehicle Dept. Alexandria, VA	Failed safety inspection
01/30/2017	76,759	Virginia Inspection Station	Passed safety inspection
02/06/2017	76,945	Virginia Inspection Station	

05/04/2017

Damage Report



Accident reported: minor damage with another motor vehicle

Damage to left side
 Damage to left front
 Airbags did not deploy



CARFAX HAS THE MOST ACCIDENT & DAMAGE INFORMATION

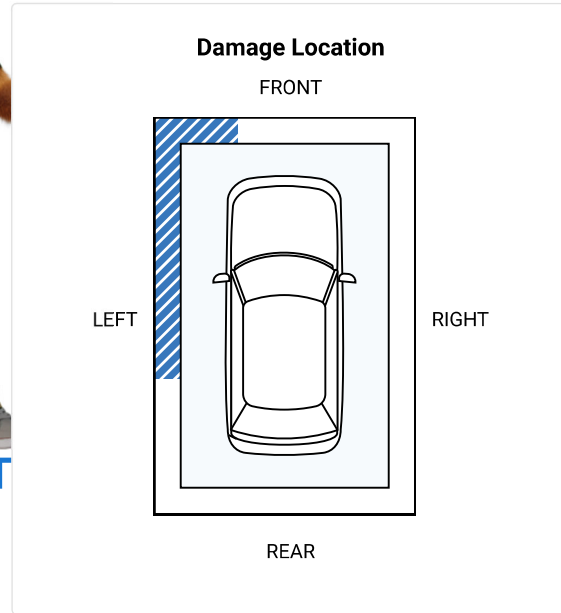
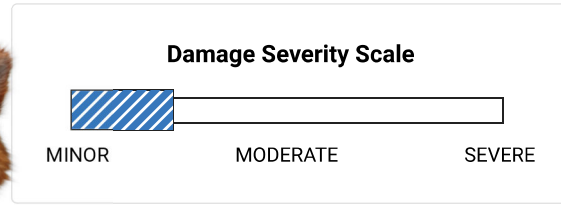

02/15/2018 87,000

Virginia
 Inspection Station

Passed safety inspection
 Passed emissions inspection

02/26/2018

Virginia
 Motor Vehicle Dept.
 Alexandria, VA

Registration issued or renewed

08/21/2018 91,186

Beyer Subaru
 Alexandria, VA
 703-768-5800
<https://beyersubaru.com>



Vehicle serviced
 Maintenance inspection completed
 Vehicle washed/detailed

★ **4.7 / 5.0**
 1,031 Verified Reviews
 ❤️ **9,294** Customer Favorites

02/21/2019 94,893

Virginia
 Inspection Station

Passed safety inspection

02/20/2020 102,000

Virginia
 Inspection Station

Passed emissions inspection

02/20/2020	102,077	Virginia Inspection Station	Passed safety inspection
02/20/2020		Virginia Motor Vehicle Dept. Alexandria, VA	Registration issued or renewed



Hmm, we haven't received any information on this car since February 2020. Before you buy, ask the seller for recent service or repair records.

Have Questions? Consumers, please visit our Help Center at www.carfax.com. Dealers or Subscribers, please visit our Help Center at www.carfaxonline.com.



Glossary

Accident Indicator

CARFAX receives information about accidents in all 50 states, the District of Columbia and Canada.

Not every accident is reported to CARFAX. As details about the accident become available, those additional details are added to the CARFAX Vehicle History Report. CARFAX recommends that you have this vehicle inspected by a qualified mechanic.

- According to the National Safety Council, Injury Facts, 2021 edition, 5% of the 276 million registered vehicles in the U.S. were involved in an accident in 2019. Over 77% of these were considered minor or moderate.
- This CARFAX Vehicle History Report is based only on information supplied to CARFAX and available as of 5/12/23 at 3:31:59 PM (CDT). Other information about this vehicle, including problems, may not have been reported to CARFAX. Use this report as one important tool, along with a vehicle inspection and test drive, to make a better decision about your next used car.

Damage Indicator

Damage can be a result of many different types of events. Examples include contact with objects (other cars, trees, traffic signs, road debris, etc), vandalism, or weather-related events. Not every damage event is reported to CARFAX. As details about the damage event become available, those additional details are added to the CARFAX Vehicle History Report. CARFAX recommends that you have this vehicle inspected by a qualified mechanic.

- This CARFAX Vehicle History Report is based only on information supplied to CARFAX and available as of 5/12/23 at 3:31:59 PM (CDT). Other information about this vehicle, including problems, may not have been reported to CARFAX. Use this report as one important tool, along with a vehicle inspection and test drive, to make a better decision about your next used car.

Damage Severity

Damage events result in one of the following severity levels:

- **Minor:** Generally, minor damage is cosmetic (including dents or scratches), may only require reconditioning, and typically does not compromise a vehicle's operation and/or safety.
- **Moderate:** Moderate damage may affect multiple components of the vehicle and may impair the vehicle's operation and/or safety.
- **Severe:** Severe damage usually affects multiple components of the vehicle and is likely to compromise the vehicle's operation and/or safety.

CARFAX recommends getting a pre-purchase inspection at a certified collision repair facility.

First Owner



When the first owner(s) obtains a title from a Department of Motor Vehicles as proof of ownership.

Ownership History

CARFAX defines an owner as an individual or business that possesses and uses a vehicle. Not all title transactions represent changes in ownership. To provide estimated number of owners, CARFAX proprietary technology analyzes all the events in a vehicle history. Estimated ownership is available for vehicles manufactured after 1991 and titled solely in the US including Puerto Rico. Dealers sometimes opt to take ownership of a vehicle and are required to in the following states: Maine, Massachusetts, New Jersey, Ohio, Oklahoma, Pennsylvania and South Dakota. Please consider this as you review a vehicle's estimated ownership history.

Title Issued

A state issues a title to provide a vehicle owner with proof of ownership. Each title has a unique number. Each title or registration record on a CARFAX report does not necessarily indicate a change in ownership. In Canada, a registration and bill of sale are used as proof of ownership.

Follow Us:  facebook.com/CARFAX  [@CARFAXinc](https://twitter.com/CARFAXinc)  **About CARFAX**

CARFAX DEPENDS ON ITS SOURCES FOR THE ACCURACY AND RELIABILITY OF ITS INFORMATION. THEREFORE, NO RESPONSIBILITY IS ASSUMED BY CARFAX OR ITS AGENTS FOR ERRORS OR OMISSIONS IN THIS REPORT. CARFAX FURTHER EXPRESSLY DISCLAIMS ALL WARRANTIES, EXPRESS OR IMPLIED, INCLUDING ANY IMPLIED WARRANTIES OF MERCHANTABILITY OR FITNESS FOR A PARTICULAR PURPOSE.

© 2023 CARFAX, Inc., part of S&P Global. All rights reserved.
5/12/23 3:31:59 PM (CDT)

I have reviewed and received a copy of the CARFAX Vehicle History Report for this 2010 SUBARU FORESTER vehicle (VIN: JF2SH6DC0AH749393), which is based on information supplied to CARFAX and available as of 5/12/23 at 4:31 PM (EDT).

Customer Signature

Date

Dealer Signature

Date