



History-Based Value Report

\$6,080

CARFAX Retail Value

History events affecting this vehicle's value

- 1-Owner Vehicle
- Personal Vehicle
- Accident Reported



Vehicle History Report™

US \$44.99

2008 HONDA ODYSSEY LX

VIN: 5FNRL38278B012438
 VAN
 3.5L V6 F SOHC 24V
 GASOLINE
 FRONT WHEEL DRIVE

- Accident reported
- 16** Service history records
- CARFAX 1-Owner vehicle
- Personal vehicle
- Last owned in New Hampshire
- 131,799** Last reported odometer reading



This CARFAX Vehicle History Report is based only on information supplied to CARFAX and available as of 2/5/25 at 12:16:14 PM (CST). Other information about this vehicle, including problems, may not have been reported to

CARFAX. Use this report as one important tool, along with a vehicle inspection and test drive, to make a better decision about your next used car.



Accident / Damage History

Not all accidents / issues are reported to CARFAX

Event 1

09/03/2010

Accident reported with another motor vehicle

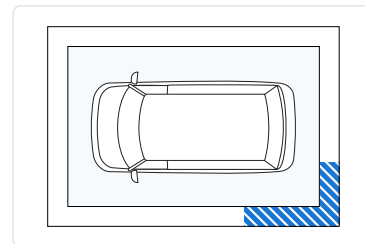

Event 2

10/26/2010

Accident reported with another motor vehicle

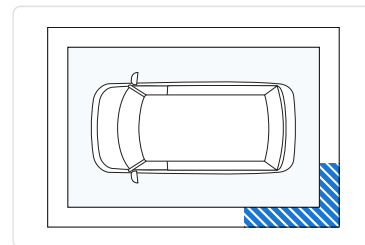

Additional History

Not all accidents / issues are reported to CARFAX

Owner 1

Total Loss

No total loss reported to CARFAX.

✓ No Issues Reported

Structural Damage

CARFAX recommends that you have this vehicle inspected by a collision repair specialist.

✓ No Issues Reported

Airbag Deployment

No airbag deployment reported to CARFAX.

✓ No Issues Reported

Odometer Check

No indication of an odometer rollback.

✓ No Issues Indicated

Accident / Damage

Accidents reported: 09/03/2010 and 10/26/2010.

Accident Reported

Manufacturer Recall

No open recalls reported to CARFAX.



✓ No Recalls Reported





Basic Warranty Original warranty estimated to have expired.	Warranty Expired
---	-------------------------





CARFAX Title History CARFAX guarantees the information in this section	Owner 1
Damage Brands Salvage Junk Rebuilt Fire Flood Hail Lemon	<input checked="" type="checkbox"/> Guaranteed No Problem
Odometer Brands Not Actual Mileage Exceeds Mechanical Limits	<input checked="" type="checkbox"/> Guaranteed No Problem
 GUARANTEED - None of these title problems were reported by a U.S. state Department of Motor Vehicles (DMV). If you find that any of these title problems were reported by a DMV and not included in this report, you may qualify. View Terms View Certificate	

CARFAX Ownership History The number of owners is estimated	Owner 1
Year purchased	2007
Type of owner	Personal
Estimated length of ownership	17 yrs. 1 mo.
Owned in the following states/provinces	New Hampshire
Estimated miles driven per year	7,806/yr
Last reported odometer reading	131,799



CARFAX Detailed History			
 Owner 1 Purchased: 2007		Low mileage! This owner drove less than the industry average of 15,000 miles per year.	Personal Vehicle 7,806 mi/yr
Date	Mileage	Source	Comments
11/26/2007	10	Autofair Ford Inc. Manchester, NH 603-634-1000 autofairfordinc.com/	Vehicle offered for sale

12/07/2007	AutoFair Honda Manchester, NH 833-501-0381 autofairhonda.com/		Vehicle serviced Pre-delivery inspection completed
	★ 4.5 / 5.0 170 Verified Reviews ❤️ 230 Customer Favorites		
12/17/2007	AutoFair Honda Manchester, NH 833-501-0381 autofairhonda.com/		Vehicle serviced Spark plug(s) replaced
	★ 4.5 / 5.0 170 Verified Reviews ❤️ 230 Customer Favorites		
12/26/2007	New Hampshire Motor Vehicle Dept.		Vehicle purchase reported
01/02/2008	New Hampshire Motor Vehicle Dept. Merrimack, NH Title #11156389		Title issued or updated First owner reported Titled or registered as personal vehicle Loan or lien reported Vehicle color noted as Gray
01/12/2008 461	AutoFair Honda Manchester, NH 833-501-0381 autofairhonda.com/		Vehicle serviced Emissions inspection performed Emissions or safety inspection performed
	★ 4.5 / 5.0 170 Verified Reviews ❤️ 230 Customer Favorites		
01/12/2008	New Hampshire Inspection Station Hillsborough County		Passed emissions inspection
06/21/2008 5,271	AutoFair Honda Manchester, NH 833-501-0381 autofairhonda.com/		Vehicle serviced Maintenance inspection completed Oil and filter changed Tires rotated
	★ 4.5 / 5.0 170 Verified Reviews ❤️ 230 Customer Favorites		

10/25/2008	11,836	AutoFair Honda Manchester, NH 833-501-0381 autofairhonda.com/ ★ 4.5 / 5.0 170 Verified Reviews ❤️ 230 Customer Favorites		Vehicle serviced Maintenance inspection completed Recommended maintenance performed
11/13/2008	12,000	New Hampshire Inspection Station Hillsborough County		Passed emissions inspection
11/20/2008		New Hampshire Motor Vehicle Dept. Merrimack, NH		Registration issued or renewed Vehicle color noted as Gray
05/09/2009	16,868	AutoFair Honda Manchester, NH 833-501-0381 autofairhonda.com/ ★ 4.5 / 5.0 170 Verified Reviews ❤️ 230 Customer Favorites		Vehicle serviced Maintenance inspection completed Recommended maintenance performed Cabin air filter replaced/cleaned
10/31/2009		AutoFair Honda Manchester, NH 833-501-0381 autofairhonda.com/ ★ 4.5 / 5.0 170 Verified Reviews ❤️ 230 Customer Favorites		Vehicle serviced Recommended maintenance performed Maintenance inspection completed Safety inspection performed Emissions inspection performed
10/31/2009	23,000	New Hampshire Inspection Station Hillsborough County		Passed emissions inspection
11/10/2009		New Hampshire Motor Vehicle Dept. Merrimack, NH		Registration issued or renewed Vehicle color noted as Gray
11/12/2009	23,920	AutoFair Honda Manchester, NH 833-501-0381 autofairhonda.com/ ★ 4.5 / 5.0 170 Verified Reviews ❤️ 230 Customer Favorites		Vehicle serviced

04/28/2010 28,981

AutoFair Honda
Manchester, NH
833-501-0381
autofairhonda.com/

★ 4.5 / 5.0

170 Verified Reviews

♥ 230 Customer Favorites



Vehicle serviced

Recommended maintenance performed
Maintenance inspection completed

06/22/2010 30,555

AutoFair Honda
Manchester, NH
833-501-0381
autofairhonda.com/

★ 4.5 / 5.0

170 Verified Reviews

♥ 230 Customer Favorites



Vehicle serviced

PCM reprogrammed

09/03/2010

Damage Report



Accident reported with another motor vehicle

Damage to left rear

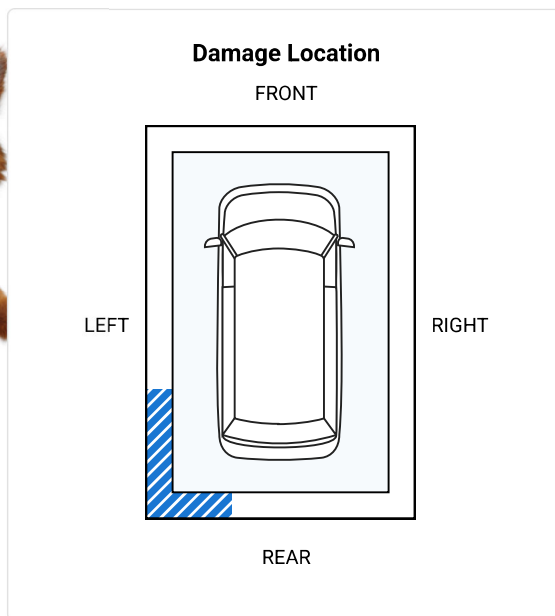

CARFAX HAS THE MOST ACCIDENT & DAMAGE INFORMATION

10/26/2010

Damage Report



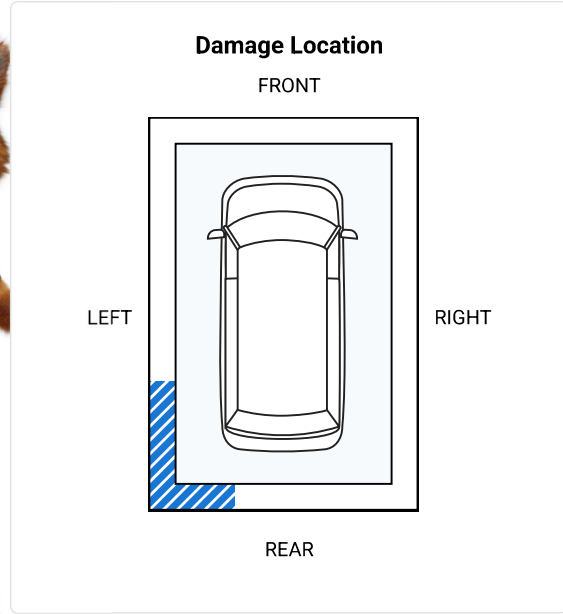

Accident reported with another motor vehicle

Damage to left rear





CARFAX HAS THE MOST ACCIDENT & DAMAGE INFORMATION

11/09/2010		New Hampshire Motor Vehicle Dept. Merrimack, NH		Registration issued or renewed Vehicle color noted as Gray
11/19/2010	36,000	New Hampshire Inspection Station Hillsborough County		Passed emissions inspection
05/14/2011	40,080	AutoFair Honda Manchester, NH 833-501-0381 autofairhonda.com/ ★ 4.5 / 5.0 170 Verified Reviews ❤️ 230 Customer Favorites		Vehicle serviced Maintenance inspection completed Recommended maintenance performed
11/07/2011		New Hampshire Motor Vehicle Dept. Merrimack, NH		Registration issued or renewed Vehicle color noted as Gray
11/21/2011	46,000	New Hampshire Inspection Station Hillsborough County		Passed emissions inspection
11/08/2012		New Hampshire Motor Vehicle Dept. Merrimack, NH		Registration issued or renewed Vehicle color noted as Gray

11/12/2012	58,000	New Hampshire Inspection Station Hillsborough County		Failed emissions inspection
11/14/2012		New Hampshire Inspection Station Hillsborough County		Passed emissions inspection
11/04/2013		New Hampshire Motor Vehicle Dept. Merrimack, NH		Registration issued or renewed Vehicle color noted as Gray
11/06/2013	69,000	New Hampshire Inspection Station Hillsborough County		Passed emissions inspection
05/08/2014	75,226	AutoFair Honda Manchester, NH 833-501-0381 autofairhonda.com/ ★ 4.5 / 5.0 170 Verified Reviews ❤️ 230 Customer Favorites		Vehicle serviced Maintenance inspection completed Brakes checked Wiper(s) replaced Brake fluid flushed/changed Power steering fluid flushed/changed Drive belts checked Fluids checked Oil and filter changed Transmission fluid changed Yaw rate sensor replaced Tires rotated Rear brakes replaced
09/30/2014	80,192	AutoFair Honda Manchester, NH 833-501-0381 autofairhonda.com/ ★ 4.5 / 5.0 170 Verified Reviews ❤️ 230 Customer Favorites		Vehicle serviced Maintenance inspection completed Fuel filter replaced
11/04/2014	81,000	New Hampshire Inspection Station Hillsborough County		Passed emissions inspection
11/06/2014		New Hampshire Motor Vehicle Dept. Merrimack, NH		Registration issued or renewed Vehicle color noted as Gray

01/20/2015	83,746	<p>AutoFair Honda Manchester, NH 833-501-0381 autofairhonda.com/</p> <p>★ 4.5 / 5.0 170 Verified Reviews ♥ 230 Customer Favorites</p>	 <p>Vehicle serviced Maintenance inspection completed Battery/charging system checked</p>
11/20/2015		<p>New Hampshire Motor Vehicle Dept. Merrimack, NH</p>	<p>Registration issued or renewed Vehicle color noted as Gray</p>
11/21/2015	93,000	<p>New Hampshire Inspection Station Hillsborough County</p>	<p>Passed emissions inspection</p>
11/09/2016		<p>New Hampshire Motor Vehicle Dept. Merrimack, NH</p>	<p>Registration issued or renewed Registration updated when owner moved the vehicle to a new location Vehicle color noted as Gray</p>
11/16/2016	106,000	<p>New Hampshire Inspection Station Hillsborough County</p>	<p>Passed emissions inspection</p>
10/31/2017		<p>New Hampshire Motor Vehicle Dept. Merrimack, NH</p>	<p>Registration issued or renewed Vehicle color noted as Gray</p>
11/28/2017	115,000	<p>New Hampshire Inspection Station Hillsborough County</p>	<p>Passed emissions inspection</p>
11/08/2018		<p>New Hampshire Motor Vehicle Dept. Merrimack, NH</p>	<p>Registration issued or renewed Vehicle color noted as Gray</p>
10/24/2019		<p>New Hampshire Motor Vehicle Dept. Merrimack, NH</p>	<p>Registration issued or renewed Vehicle color noted as Gray</p>
11/12/2019	126,000	<p>New Hampshire Inspection Station Hillsborough County</p>	<p>Passed emissions inspection</p>
11/04/2020		<p>New Hampshire Motor Vehicle Dept. Merrimack, NH</p>	<p>Registration issued or renewed Vehicle color noted as Gray</p>
11/11/2020	128,000	<p>New Hampshire Inspection Station Hillsborough County</p>	<p>Passed emissions inspection</p>

11/02/2021		New Hampshire Motor Vehicle Dept. Merrimack, NH		Registration issued or renewed Vehicle color noted as Gray
11/08/2021	129,000	New Hampshire Inspection Station Hillsborough County		Passed emissions inspection
10/25/2022		New Hampshire Motor Vehicle Dept. Merrimack, NH		Registration issued or renewed Vehicle color noted as Gray
11/07/2022	130,000	New Hampshire Inspection Station Hillsborough County		Passed emissions inspection
12/05/2023		Silva's Auto Merrimack, NH 603-424-7993 silvas-auto.com/ ★ 5.0 / 5.0 47 Verified Reviews ❤️ 2 Customer Favorites		Vehicle serviced Maintenance inspection completed Oil and filter changed Safety inspection performed Emissions inspection performed Emissions or safety inspection performed
12/05/2023	131,000	New Hampshire Inspection Station Hillsborough County		Passed emissions inspection
12/05/2023		New Hampshire Motor Vehicle Dept. Merrimack, NH		Registration issued or renewed Vehicle color noted as Gray
10/30/2024		New Hampshire Motor Vehicle Dept. Merrimack, NH		Registration issued or renewed Vehicle color noted as Gray
11/08/2024	131,799	Silva's Auto Merrimack, NH 603-424-7993 silvas-auto.com/ ★ 5.0 / 5.0 47 Verified Reviews ❤️ 2 Customer Favorites		Vehicle serviced Maintenance inspection completed Safety inspection performed Drive belts checked Emissions inspection performed Emissions or safety inspection performed

Have Questions? Consumers, please visit our Help Center at www.carfax.com. Dealers or Subscribers, please visit our Help Center at www.carfaxonline.com.



Glossary

Accident Indicator

CARFAX receives information about accidents in all 50 states, the District of Columbia and Canada.

Not every accident is reported to CARFAX. As details about the accident become available, those additional details are added to the CARFAX Vehicle History Report. CARFAX recommends that you have this vehicle inspected by a qualified mechanic.

- According to the National Safety Council, Injury Facts, 2021 edition, 5% of the 276 million registered vehicles in the U.S. were involved in an accident in 2019. Over 77% of these were considered minor or moderate.
- This CARFAX Vehicle History Report is based only on information supplied to CARFAX and available as of 2/5/25 at 12:16:14 PM (CST). Other information about this vehicle, including problems, may not have been reported to CARFAX. Use this report as one important tool, along with a vehicle inspection and test drive, to make a better decision about your next used car.

Failed Emissions Inspection

The emissions check performed during a vehicle inspection indicated the vehicle was emitting more than allowable emissions standards and/or had missing or modified parts. Repeated failed emissions records can indicate engine problems and CARFAX recommends you have the vehicle inspected.

First Owner

When the first owner(s) obtains a title from a Department of Motor Vehicles as proof of ownership.

Ownership History

CARFAX defines an owner as an individual or business that possesses and uses a vehicle. Not all title transactions represent changes in ownership. To provide estimated number of owners, CARFAX proprietary technology analyzes all the events in a vehicle history. Estimated ownership is available for vehicles manufactured after 1991 and titled solely in the US including Puerto Rico. Dealers sometimes opt to take ownership of a vehicle and are required to in the following states: Maine, Massachusetts, New Jersey, Ohio, Oklahoma, Pennsylvania and South Dakota. Please consider this as you review a vehicle's estimated ownership history.

Title Issued

A state issues a title to provide a vehicle owner with proof of ownership. Each title has a unique number. Each title or registration record on a CARFAX report does not necessarily indicate a change in ownership. In Canada, a registration and bill of sale are used as proof of ownership.

Follow Us:



[facebook.com/CARFAX](https://www.facebook.com/CARFAX)



[@CARFAXinc](https://twitter.com/CARFAXinc)



About CARFAX

CARFAX DEPENDS ON ITS SOURCES FOR THE ACCURACY AND RELIABILITY OF ITS INFORMATION. THEREFORE, NO RESPONSIBILITY IS ASSUMED BY CARFAX OR ITS AGENTS FOR ERRORS OR OMISSIONS IN THIS REPORT. CARFAX FURTHER EXPRESSLY DISCLAIMS ALL WARRANTIES, EXPRESS OR IMPLIED, INCLUDING ANY IMPLIED WARRANTIES OF MERCHANTABILITY OR FITNESS FOR A PARTICULAR PURPOSE.

© 2025 CARFAX, Inc., part of S&P Global. All rights reserved.
2/5/25 12:16:14 PM (CST)

I have reviewed and received a copy of the CARFAX Vehicle History Report for this 2008 HONDA ODYSSEY vehicle (VIN: 5FNRL38278B012438), which is based on information supplied to CARFAX and available as of 2/5/25 at 1:16 PM (EST).

Customer Signature

Date

Dealer Signature

Date