



### History-Based Value Report

**\$5,740**

CARFAX Retail Value

#### History events affecting this vehicle's value

- Service History
- Personal Vehicle
- Open Recall
- Damage



### Vehicle History Report™

US \$44.99

**2009 CADILLAC CTS  
3.6L V6**

VIN: 1G6DG577690154676  
SEDAN 4 DR  
3.6L V6 F DOHC 24V  
GASOLINE  
ALL WHEEL DRIVE

Damage reported

**19** Service history records

At least 1 open recall

**3** Previous owners

Types of owners: Personal lease, Personal

**129,571** Last reported odometer reading

**CARFAX HAS THE MOST  
ACCIDENT & DAMAGE  
INFORMATION**



[^ Back To Top](#)

This CARFAX Vehicle History Report is based only on information supplied to CARFAX and available as of 12/22/24 at 8:14:24 AM (CST). Other information about this vehicle, including problems, may not have been reported to CARFAX. Use this report as one important tool, along with a vehicle inspection and test drive, to make a better decision about your next used car.



## Accident / Damage History

Not all accidents / issues are reported to CARFAX

### Event 1

12/08/2011

**Accident reported:  
minor damage with  
another motor vehicle**

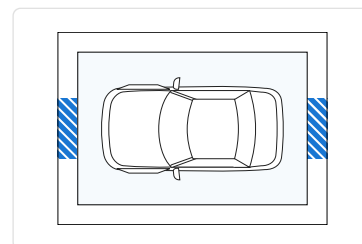
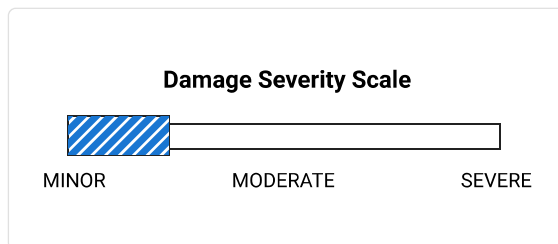

### Event 2

05/07/2014

**Accident reported:  
very minor damage  
with another motor  
vehicle**

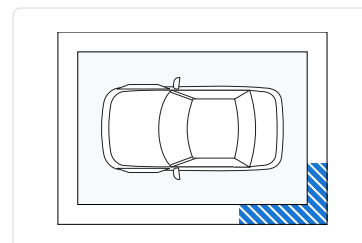
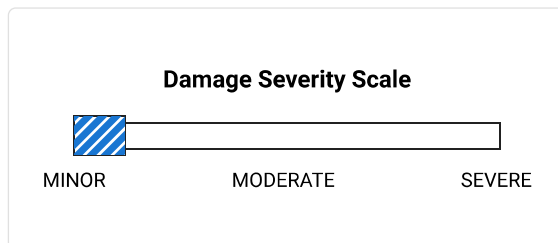

### Event 3

07/14/2014

**Damage repairs performed**

- Repairs to rear
- Repairs to left rear

### Event 4

01/17/2016

**Accident reported:  
minor damage**

- It hit a guardrail
- Vehicle ran off road
- Vehicle towed

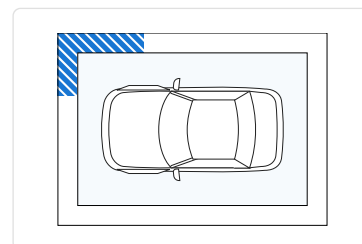
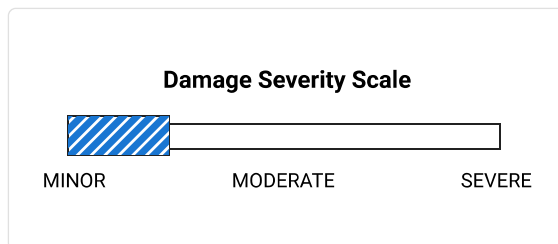

[^ Back To Top](#)

Event 5

10/01/2016

**Accident reported:  
minor damage with  
another motor vehicle**  
Airbags did not deploy

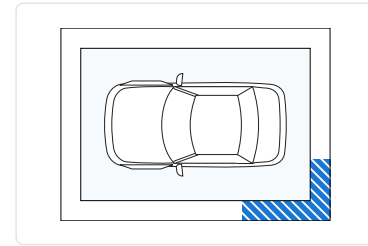
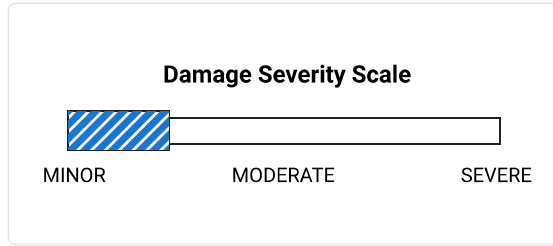

Event 6

02/23/2021

**Damage reported**

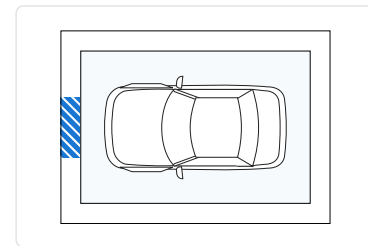







**Additional History**

Not all accidents / issues are reported to CARFAX

	Owner 1	Owner 2	Owner 3
<b>Total Loss</b> No total loss reported to CARFAX.	<input checked="" type="checkbox"/> No Issues Reported	<input checked="" type="checkbox"/> No Issues Reported	<input checked="" type="checkbox"/> No Issues Reported
<b>Structural Damage</b> CARFAX recommends that you have this vehicle inspected by a collision repair specialist.	<input checked="" type="checkbox"/> No Issues Reported	<input checked="" type="checkbox"/> No Issues Reported	<input checked="" type="checkbox"/> No Issues Reported
<b>Airbag Deployment</b> No airbag deployment reported to CARFAX.	<input checked="" type="checkbox"/> No Issues Reported	<input checked="" type="checkbox"/> No Issues Reported	<input checked="" type="checkbox"/> No Issues Reported
<b>Odometer Check</b> No indication of an odometer rollback.	<input checked="" type="checkbox"/> No Issues Indicated	<input checked="" type="checkbox"/> No Issues Indicated	<input checked="" type="checkbox"/> No Issues Indicated
<b>Accident / Damage</b> Accidents reported: 12/08/2011, 05/07/2014, 01/17/2016, and 10/01/2016. Damage repairs reported: 07/14/2014. Damage reported: 02/23/2021.	Accident Reported	Accident Reported	No New Issues Reported
<b>Manufacturer Recall</b> At least 1 manufacturer recall requires service. Check for open recalls or schedule dealer service on GM vehicles at recalls.gm.com.	<input checked="" type="checkbox"/> No Recalls Reported	Recall Reported	No New Recalls

^ **Back To Top**

<b>Basic Warranty</b> Original warranty estimated to have expired.	<b>Warranty Expired</b>	<b>Warranty Expired</b>	<b>Warranty Expired</b>
---	-------------------------	-------------------------	-------------------------

 <b>Title History</b> CARFAX guarantees the information in this section	Owner 1	Owner 2	Owner 3
<b>Damage Brands</b> Salvage   Junk   Rebuilt   Fire   Flood   Hail   Lemon	 <b>Guaranteed</b> No Problem	 <b>Guaranteed</b> No Problem	 <b>Guaranteed</b> No Problem
<b>Odometer Brands</b> Not Actual Mileage   Exceeds Mechanical Limits	 <b>Guaranteed</b> No Problem	 <b>Guaranteed</b> No Problem	 <b>Guaranteed</b> No Problem



**GUARANTEED** - None of these title problems were reported by a U.S. state Department of Motor Vehicles (DMV). If you find that any of these title problems were reported by a DMV and not included in this report, you may qualify.  
View Terms | View Certificate

 <b>Ownership History</b> The number of owners is estimated	Owner 1	Owner 2	Owner 3
Year purchased	2009	2013	2021
Type of owner	Personal lease	Personal	Personal
Estimated length of ownership	4 yrs. 1 mo.	7 yrs. 7 mo.	3 yrs. 6 mo.
Owned in the following states/provinces	Michigan	Michigan	Michigan
Estimated miles driven per year	10,397/yr	17,772/yr	--
Last reported odometer reading	44,475	129,557	129,571

 **Detailed History**



**Owner 1**  
Purchased: 2009





**Low mileage!** This owner drove less than the industry average of 15,000 miles per year.

Personal Lease Vehicle  
10,397 mi/yr

Date	Mileage	Source	Comments
12/11/2008	11	Suburban Collection suburbancollection.com ★ 4.6 / 5.0 668 Verified Reviews	 <b>Vehicle serviced</b> Pre-delivery inspection completed Battery/charging system checked Vehicle washed/detail Electrical system checked

[^ Back To Top](#)

03/09/2009	13	Suburban Collection suburbancollection.com ★ 4.6 / 5.0 668 Verified Reviews		<b>Vehicle serviced</b> Electrical system checked
03/30/2009	27	Suburban Collection suburbancollection.com ★ 4.4 / 5.0 189 Verified Reviews		<b>Vehicle sold</b>
04/01/2009		Michigan Motor Vehicle Dept. Rochester, MI Title #175X0910353		<b>Title or registration issued</b> First owner reported Titled or registered as personal lease vehicle
10/15/2009		Michigan Motor Vehicle Dept. Rochester, MI Title #175X0910353		<b>Title or registration issued</b>
10/22/2010		Michigan Motor Vehicle Dept. Rochester, MI Title #175X0910353		<b>Title or registration issued</b>
10/12/2011		Michigan Motor Vehicle Dept. Rochester, MI		<b>Registration issued or renewed</b>
12/08/2011		Damage Report		<b>Accident reported: minor damage with another motor vehicle</b> Damage to rear Damage to front

[^ Back To Top](#)



**CARFAX HAS THE MOST ACCIDENT & DAMAGE INFORMATION**

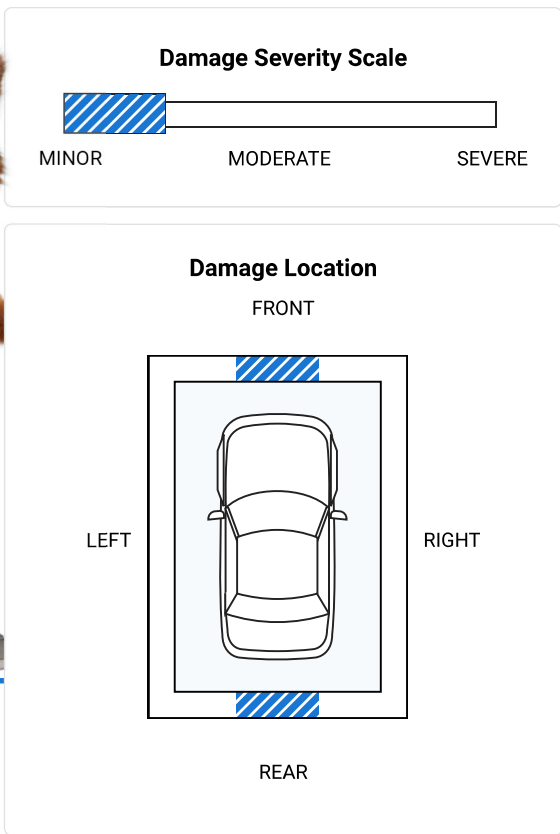

12/26/2011 32,110

Wally Edgar Chevrolet Inc.  
Lake Orion, MI  
248-391-9900  
wallyedgar.com/

★ 4.6 / 5.0

315 Verified Reviews

♥ 3,666 Customer Favorites



**Vehicle serviced**

Exhaust system replaced  
Exhaust replaced

06/07/2012 37,366

Wally Edgar Chevrolet Inc.  
Lake Orion, MI  
248-391-9900  
wallyedgar.com/

★ 4.6 / 5.0

315 Verified Reviews

♥ 3,666 Customer Favorites



**Vehicle serviced**

Maintenance inspection completed  
Brakes checked  
Oil and filter changed  
Tires rotated

09/26/2012

Michigan  
Motor Vehicle Dept.  
Rochester, MI

**Registration issued or renewed**

^ Back To Top

03/28/2013	43,672	Harvey Cadillac Grand Rapids, MI 616-949-1140 harveycadillac.com ★ 4.6 / 5.0 150 Verified Reviews ❤️ 93 Customer Favorites	 <b>Vehicle serviced</b> Driveshaft replaced Radio/sound system repaired
------------	--------	--	---

05/16/2013		Dealer Inventory	<b>Vehicle offered for sale</b>
------------	--	------------------	---------------------------------

06/28/2013	44,125	Auto Auction	<b>Vehicle offered for sale</b> Vehicle sold
------------	--------	--------------	---



Millions of used vehicles are bought and sold at auction every year.

07/08/2013		Dave's Jackson Nissan Jackson, MI 517-788-8300 davesjacksonnissan.com ★ 4.3 / 5.0 11 Verified Reviews	<b>Vehicle offered for sale</b>
------------	--	--	---------------------------------

07/09/2013	44,475	Dave's Jackson Nissan Jackson, MI 517-788-8300 davesjacksonnissan.com ★ 4.3 / 5.0 11 Verified Reviews	<b>Vehicle sold</b>
------------	--------	--	---------------------

 <b>Owner 2</b> Purchased: 2013	Personal Vehicle 17,772 mi/yr
---	----------------------------------

Date	Mileage	Source	Comments
07/18/2013		Michigan Motor Vehicle Dept. Hillsdale, MI Title #603B1990239	<b>Title or registration issued</b> New owner reported
10/18/2013		Michigan Motor Vehicle Dept. Hillsdale, MI	<b>Registration issued or renewed</b>
05/07/2014		Damage Report	 <b>Accident reported: very minor damage with another motor vehicle</b> Damage to left rear

^ Back To Top



**CARFAX HAS THE MOST ACCIDENT & DAMAGE INFORMATION**

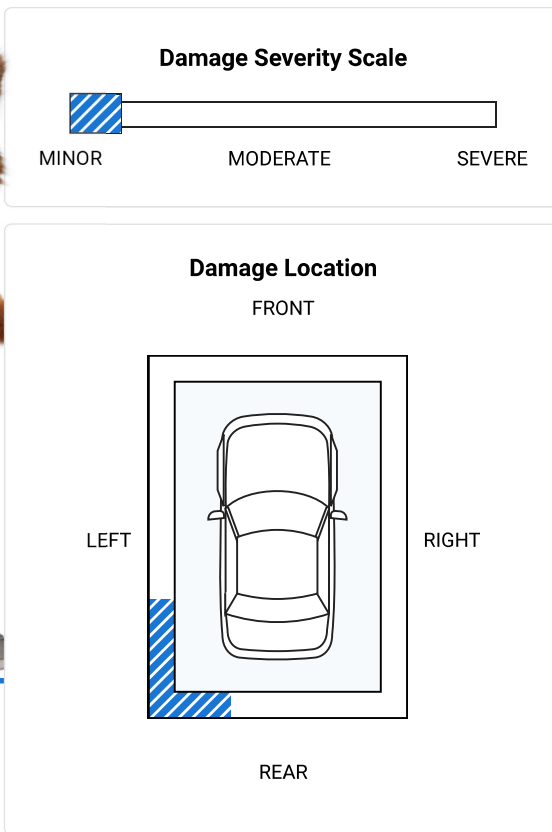

07/14/2014	Frank Beck Chevrolet-Cadillac Hillsdale, MI		<b>Damage repairs performed</b> Repairs to rear Repairs to left rear
07/21/2014	General Motors		<b>Manufacturer Safety recall issued</b> NHTSA #14V394 Transport Canada# 2014273 Recall #N140172 UNINTENDED IGNITION KEY ROTATION Status: Remedy Available  Locate an authorized General Motors dealer to obtain more information about this recall.  <a href="#">⊖ Learn more about this recall</a>

[^ Back To Top](#)



**Description:** General Motors has decided that a defect which relates to motor vehicle safety exists in certain 2003-2014 MY Cadillac CTS and 2004-2006 MY Cadillac SRX vehicles. If the key ring is carrying added weight and the vehicle goes off road or experiences some other jarring event, or if the driver unintentionally bumps the key ring or items attached to the key ring with their knee, the key may unintentionally move away from the "run" position. If this occurs, engine power, power steering and power braking may be affected, increasing the risk of a crash.

The timing of the key movement out of the "run" position, relative to the activation of the sensing algorithm of the crash event, may result in the airbags not deploying, increasing the potential for occupant injury in certain kinds of crashes. Customers should remove all items from their key rings, including the key fob, leaving only the ignition key. In addition it is very important that drivers adjust their seat and steering column to allow clearance between their knee and the ignition key.

**Remedy:** Dealers are to install two key rings and an insert in the key slot or a cover over the key head on all ignition keys, free of charge. Until the recall has been

08/06/2014 62,608

Hillsdale Lube  
Hillsdale, MI  
517-437-7050



**Vehicle serviced**  
Oil and filter changed

★ 5.0 / 5.0

66 Verified Reviews

♥ 64 Customer Favorites

10/13/2014

Michigan  
Motor Vehicle Dept.  
Hillsdale, MI

**Registration issued or renewed**

10/15/2014

Frank Beck Chevrolet-  
Cadillac  
Hillsdale, MI  
517-849-2886  
frankbeckchevrolet.com



**Vehicle serviced**

★ 4.8 / 5.0

52 Verified Reviews

♥ 2 Customer Favorites

12/05/2014 68,938

Hillsdale Lube  
Hillsdale, MI  
517-437-7050



**Vehicle serviced**  
Oil and filter changed

★ 5.0 / 5.0

66 Verified Reviews

♥ 64 Customer Favorites

04/08/2015 75,460

Hillsdale Lube  
Hillsdale, MI  
517-437-7050



**Vehicle serviced**  
Oil and filter changed

★ 5.0 / 5.0

66 Verified Reviews

♥ 64 Customer Favorites

^ Back To Top

06/12/2015 78,008

Frank Beck Chevrolet-Cadillac  
Hillsdale, MI  
517-849-2886  
frankbeckchevrolet.com



**Vehicle serviced**

★ 4.8 / 5.0

52 Verified Reviews

♥ 2 Customer Favorites

08/28/2015 84,900

Hillsdale Lube  
Hillsdale, MI  
517-437-7050



**Vehicle serviced**

Oil and filter changed

★ 5.0 / 5.0

66 Verified Reviews

♥ 64 Customer Favorites

10/16/2015

Michigan  
Motor Vehicle Dept.  
Hillsdale, MI

**Registration issued or renewed**

01/17/2016

Damage Report



**Accident reported: minor damage**







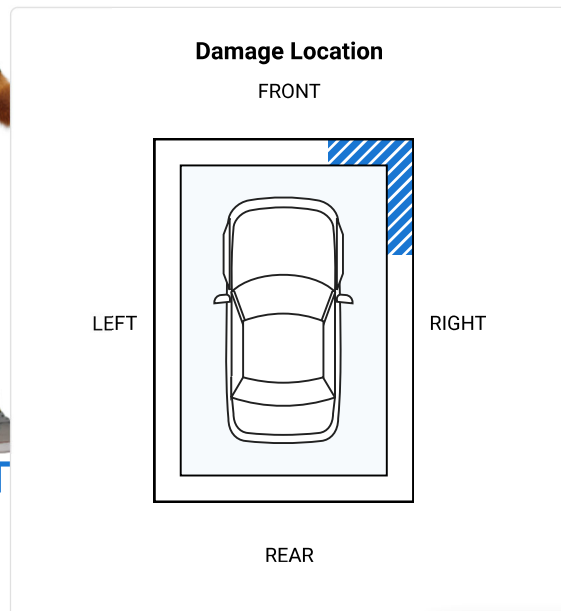
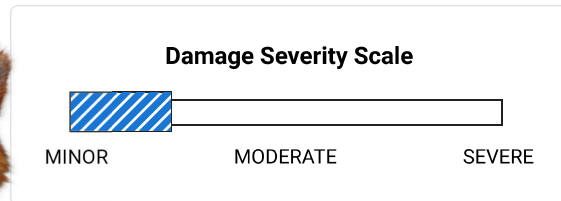

It hit a guardrail  
Vehicle ran off road  
Damage to right front  
Vehicle towed



**CARFAX HAS THE MOST ACCIDENT & DAMAGE INFORMATION**



[^ Back To Top](#)



01/20/2016 90,061	Jimmie's Jackson, MI 517-750-4400 ★ <b>4.9 / 5.0</b> 7 Verified Reviews	 <b>Vehicle serviced</b> Tie rod end(s) replaced Four wheel alignment performed
02/10/2016 91,119	Southern Michigan Motors Hillsdale, MI 517-437-7334 southernmichiganmotor s.com/ ★ <b>4.9 / 5.0</b> 93 Verified Reviews  <b>133</b> Customer Favorites	 <b>Vehicle serviced</b> Alignment performed
03/14/2016 92,829	Hillsdale Lube Hillsdale, MI 517-437-7050 ★ <b>5.0 / 5.0</b> 66 Verified Reviews  <b>64</b> Customer Favorites	 <b>Vehicle serviced</b> Oil and filter changed
08/15/2016 101,181	Hillsdale Lube Hillsdale, MI 517-437-7050 ★ <b>5.0 / 5.0</b> 66 Verified Reviews  <b>64</b> Customer Favorites	 <b>Vehicle serviced</b> Oil and filter changed
10/01/2016	Damage Report	 <b>Accident reported: minor damage with another motor vehicle</b> Damage to left rear Airbags did not deploy

[^ Back To Top](#)

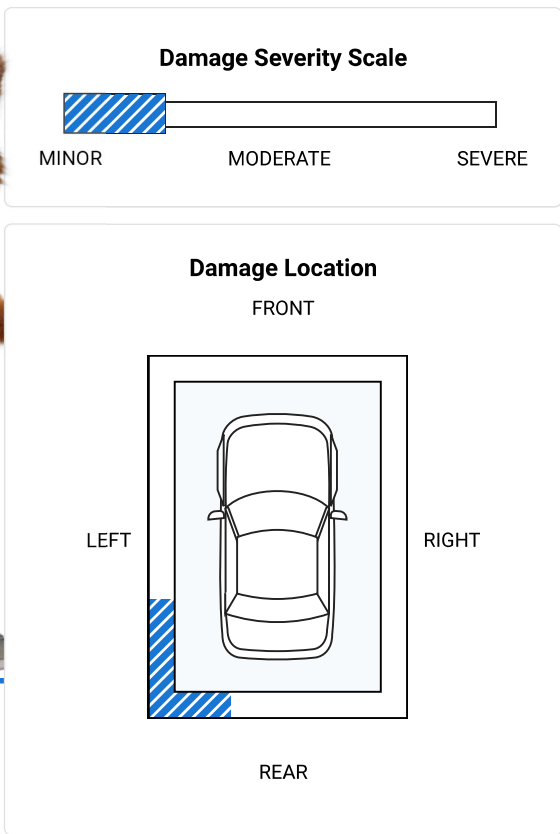

**CARFAX HAS THE MOST ACCIDENT & DAMAGE INFORMATION**



10/20/2016	Michigan Motor Vehicle Dept. Hillsdale, MI	<b>Registration issued or renewed</b>
05/20/2017	112,175 Hillsdale Lube Hillsdale, MI 517-437-7050 ★ 5.0 / 5.0 66 Verified Reviews ❤️ 64 Customer Favorites	 <b>Vehicle serviced</b> Oil and filter changed
10/19/2017	Michigan Motor Vehicle Dept. Hillsdale, MI	<b>Registration issued or renewed</b>
06/03/2019	Michigan Motor Vehicle Dept. Hillsdale, MI	<b>Registration issued or renewed</b>
10/19/2020	Michigan Motor Vehicle Dept. Hillsdale, MI	<b>Registration issued or renewed</b>
02/23/2021	Damage Report	 <b>Damage reported</b> Damage to front

[^ Back To Top](#)

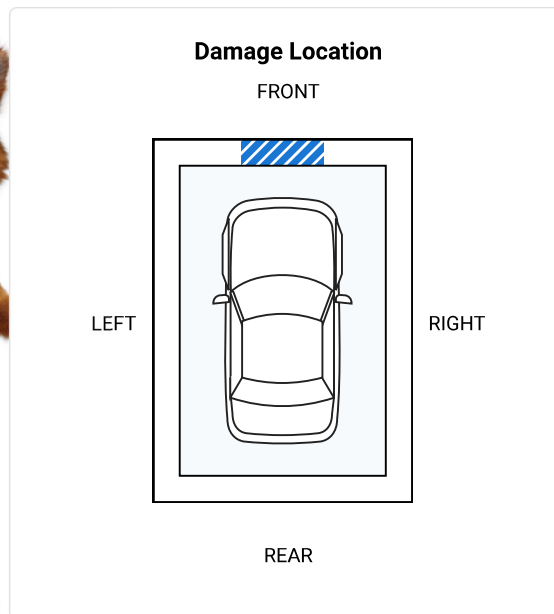

**CARFAX HAS THE MOST ACCIDENT & DAMAGE INFORMATION**



Not all damage is caused by an accident. Get the car inspected before you buy. [Learn More](#)

05/10/2021    129,557    Monkey Wrench Auto Repair  
 Portage, MI  
 269-327-4267  
<https://monkeywrenchautorepair.com/>



**Vehicle serviced**

**Owner 3**  
 Purchased: 2021

Personal Vehicle

Date	Mileage	Source	Comments
05/24/2021		Michigan Motor Vehicle Dept.	<b>Vehicle purchase reported</b>
05/27/2021		Michigan Motor Vehicle Dept. Portage, MI Title #MI0009607365	<b>Title issued or updated</b> New owner reported Exempt from odometer reporting

[^ Back To Top](#)

02/20/2024 129,568 Cole Buick GMC Cadillac  **Vehicle serviced**  
 Portage, MI  
 269-323-3200  
 colebgc.com  
 ★ 4.6 / 5.0  
 694 Verified Reviews  
 ❤️ 5,948 Customer Favorites

06/21/2024 129,571 Saif Auto  **Vehicle serviced**  
 Kalamazoo, MI  
 269-345-5181  
 Oil and filter changed  
 ABS sensor replaced  
 ★ 5.0 / 5.0  
 23 Verified Reviews  
 ❤️ 13 Customer Favorites

Have Questions? Consumers, please visit our Help Center at [www.carfax.com](http://www.carfax.com). Dealers or Subscribers, please visit our Help Center at [www.carfaxonline.com](http://www.carfaxonline.com).



## Glossary

### Accident Indicator

CARFAX receives information about accidents in all 50 states, the District of Columbia and Canada.

Not every accident is reported to CARFAX. As details about the accident become available, those additional details are added to the CARFAX Vehicle History Report. CARFAX recommends that you have this vehicle inspected by a qualified mechanic.

- According to the National Safety Council, Injury Facts, 2021 edition, 5% of the 276 million registered vehicles in the U.S. were involved in an accident in 2019. Over 77% of these were considered minor or moderate.
- This CARFAX Vehicle History Report is based only on information supplied to CARFAX and available as of 12/22/24 at 8:14:24 AM (CST). Other information about this vehicle, including problems, may not have been reported to CARFAX. Use this report as one important tool, along with a vehicle inspection and test drive, to make a better decision about your next used car.

### Collision Repair Facility

A collision repair facility specializes in repairing vehicle damage caused by accidents and other incidents. A vehicle inspection completed by your dealer or a professional inspector is recommended.

### Damage Indicator

Damage can be a result of many different types of events. Examples include contact with objects (other cars, trees, traffic signs, road debris, etc), vandalism, or weather-related events. Not every damage event is reported to CARFAX. As details about the damage event become available, those additional details are added to the CARFAX Vehicle History Report. CARFAX recommends that you have this vehicle inspected by a qualified mechanic.

- This CARFAX Vehicle History Report is based only on information supplied to CARFAX and available as of 12/22/24 at 8:14:24 AM (CST). Other information about this vehicle, including problems, may not have been reported to CARFAX. Use this report as one important tool, along with a vehicle inspection and test drive, to make a better decision about your next used car.

### Damage Severity

Damage events result in one of the following severity levels:

- Minor: Generally, minor damage is cosmetic (including dents or scratches), may only re

[^ Back To Top](#)

reconditioning, and typically does not compromise a vehicle's operation and/or safety.

- Moderate: Moderate damage may affect multiple components of the vehicle and may impair the vehicle's operation and/or safety.
- Severe: Severe damage usually affects multiple components of the vehicle and is likely to compromise the vehicle's operation and/or safety.

CARFAX recommends getting a pre-purchase inspection at a certified collision repair facility.

**First Owner**

When the first owner(s) obtains a title from a Department of Motor Vehicles as proof of ownership.

**Manufacturer Recall**

Automobile manufacturers issue recall notices to inform vehicle owners of a safety defect or failure to meet minimum federal safety or emissions standards. Manufacturer recalls are repaired at no cost to the customer.

**New Owner Reported**

When a vehicle is sold to a new owner, the Title must be transferred to the new owner(s) at a Department of Motor Vehicles.

**Ownership History**

CARFAX defines an owner as an individual or business that possesses and uses a vehicle. Not all title transactions represent changes in ownership. To provide estimated number of owners, CARFAX proprietary technology analyzes all the events in a vehicle history. Estimated ownership is available for vehicles manufactured after 1991 and titled solely in the US including Puerto Rico. Dealers sometimes opt to take ownership of a vehicle and are required to in the following states: Maine, Massachusetts, New Jersey, Ohio, Oklahoma, Pennsylvania and South Dakota. Please consider this as you review a vehicle's estimated ownership history.

**Title Issued**

A state issues a title to provide a vehicle owner with proof of ownership. Each title has a unique number. Each title or registration record on a CARFAX report does not necessarily indicate a change in ownership. In Canada, a registration and bill of sale are used as proof of ownership.

Follow Us:



[facebook.com/CARFAX](https://facebook.com/CARFAX)



[@CARFAXinc](https://twitter.com/CARFAXinc)



[About CARFAX](#)

CARFAX DEPENDS ON ITS SOURCES FOR THE ACCURACY AND RELIABILITY OF ITS INFORMATION. THEREFORE, NO RESPONSIBILITY IS ASSUMED BY CARFAX OR ITS AGENTS FOR ERRORS OR OMISSIONS IN THIS REPORT. CARFAX FURTHER EXPRESSLY DISCLAIMS ALL WARRANTIES, EXPRESS OR IMPLIED, INCLUDING ANY IMPLIED WARRANTIES OF MERCHANTABILITY OR FITNESS FOR A PARTICULAR PURPOSE.

© 2024 CARFAX, Inc., part of S&P Global. All rights reserved.  
12/22/24 8:14:24 AM (CST)

**I have reviewed and received a copy of the CARFAX Vehicle History Report for this 2009 CADILLAC CTS vehicle (VIN: 1G6DG577690154676), which is based on information supplied to CARFAX and available as of 12/22/24 at 9:14 AM (EST).**

\_\_\_\_\_  
Customer Signature

\_\_\_\_\_  
Date

\_\_\_\_\_  
Dealer Signature

\_\_\_\_\_  
Date

[^ Back To Top](#)